

# High-Precision Pressure Controller

# CPC8000



High-Precision Pressure Controller CPC8000

Version 1.5



Part of your business



**This symbol indicates that one has to reckon above all with danger for persons and the environment and/or considerable material damage (mortal danger, danger of injury) if the respective safety precautions are not taken.**



**This symbol does not indicate safety notices but information for a better understanding of the facts.**

# Contents

<b>1.</b>	<b>General notices</b>	<b>5</b>
<b>2.</b>	<b>Safety notices</b>	<b>6</b>
2.1	Duties of the user	6
2.2	General safety notices	6
2.3	Safety notices regarding operation	7
<b>3.</b>	<b>Product description</b>	<b>9</b>
3.1	Proper use	9
3.2	Structure	10
3.3	System concept: Single range Controller CPC8000-X/-L	11
3.4	System concept: Dual range Controller CPC8000-DX/-DL	12
3.5	General functional description	13
3.6	General notices regarding interface communication	15
3.7	Specification of the controller	15
3.8	Operating principle of a dual-range controller	16
3.9	Specifications	17
<b>4.</b>	<b>Installation</b>	<b>18</b>
4.1	Introduction	18
4.2	Unpacking of the system	18
4.3	Dimensions of the available versions in mm	18
4.4	Installation of the system	19
4.5	Pressure connections	20
4.6	Notices regarding the pressure connections	21
4.7	Assembly of the pressure connections	22
4.7.1	Recommendation regarding the piping	24
4.8	Electrical connections	25
4.9	Notices regarding the electrical connections	26
4.9.1	Connection of the power supply	26
4.9.2	Connection of the interfaces	26
4.9.3	Connection of the relay outputs	26
4.9.4	Connection of the WIKA-service outputs	27
<b>5.</b>	<b>Starting operation</b>	<b>29</b>
<b>6.</b>	<b>Operation</b>	<b>30</b>
6.1	Elements of the membrane keyboard	30
6.2	Functional description of the menu control block	31
6.3	Description of the keys for selecting the working mode	32
6.4	Functional description of the numerical input block	32

# High-Precision Pressure Controller CPC8000

6.5	Functional description of the control function block	33
6.6	Structure of the menu guide	33
6.7	Operating modes: MEASURE-mode, CONTROL-mode and VENT-mode	34
6.7.1	The MEASURE-mode	35
6.7.2	The CONTROL-mode	36
6.8	Menu tree	38
6.9	Calling-up the menus form out of the measuring / controlling mode	39
6.9.1	SETUP-menu point: Controller adaption	40
6.9.2	SETUP-menu point: Controller settings	42
6.9.3	SETUP-menu point: Sensor settings	44
6.9.4	SETUP-menu point: Number of windows	46
6.9.5	SETUP-menu point: General settings	48
6.9.6	SETUP-menu point: Interfaces	50
6.9.7	SETUP-menu point: User defined units	52
6.9.8	SETUP-menu point: Relay settings	54
6.9.9	SETUP-menu point: Load configuration	56
6.9.10	SETUP-menu point: Save configuration	58
6.9.11	SETUP-menu point: Info	60
6.9.12	Window-menu direct action keys: Hold, Max/Min, Zero	62
6.9.13	Window-menu direct action keys: Range, S-Temp, Barchart, Copy from Window x	64
6.9.14	Window-menu point: Sensor	66
6.9.15	Window-menu point: Unit	68
6.9.16	Window-menu point: Precision	70
6.9.17	Window-menu point: Average	72
6.9.18	Window-menu point: Limits	74
6.9.19	Window-menu point: Relay values	76
6.9.20	Window-menu point: Datalogging	78
6.9.21	Window-menu point: Test routine	80
<b>7.</b>	<b>Trouble-shooting measures</b>	<b>84</b>
7.1	Table: Fault description and measures	84
<b>8.</b>	<b>Re-calibrating and servicing</b>	<b>86</b>
<b>9.</b>	<b>Dismantling of the system</b>	<b>87</b>
<b>10.</b>	<b>Transport of the system</b>	<b>88</b>
<b>11.</b>	<b>Storage of the system</b>	<b>89</b>
<b>12.</b>	<b>Placing out of service</b>	<b>90</b>
<b>13.</b>	<b>Units and Conversion table of the SETUP-menu points: units</b>	<b>91</b>

## 1. General Notices

In the following chapters detailed information on the high-precision pneumatic pressure controller CPC8000 and its proper use can be found.

Should you require further information, or should there be problems which are not dealt with in detail in the manual, please contact the following address:

WIKA Alexander Wiegand SE & Co. KG  
Alexander Wiegand Strasse  
D-63911 Klingenberg  
Tel. +49 (0) 93 72/132-9986  
Fax. +49 (0) 93 72/132-217  
E-mail: [testequip@wika.de](mailto:testequip@wika.de)

The warranty period for the high-precision precision pressure controller CPC8000 is 24 months according to the general terms of supply of ZVEI.

All guarantee claims lapse if the system is put to improper use or if the operating instructions are not observed or if an attempt is made to open the system.

We also point out that the contents of these operating instructions does not form part of an earlier or existing agreement, assurance or legal relationship or is meant to change these. All obligations of WIKA Alexander Wiegand SE & Co. KG result from the respective sales contract and the general business terms of WIKA Alexander Wiegand SE & Co. KG.

WIKA is a registered trade mark of WIKA Alexander Wiegand SE & Co. KG. All other brand and product names are trademarks or registered trademarks of their respective companies.

We reserve the right to effect reasonable changes on the basis of technical improvements.

Any reproduction of this manual or parts thereof by any means is prohibited.

Version key regarding firmware and respective manual

Manual	Firmware
V 1.1	V 1.9.0
V 1.2	V 1.9.1
V 1.3	≤ V 1.11.1.27
V 1.4	≥ V 2.0.0.0
V 1.5	≥ V 2.0.1.5

© 2003 Copyright WIKA Alexander Wiegand SE & Co. KG.

## 2. Safety notices

### 2.1 Duties of the user

To ensure safe working with the system the user must make sure in particular that:

- the system is only used properly (cf. the section "3.1 Proper use" in the chapter "3. Product description"), no dangerous media are used and all technical specifications are being observed.
- safety mechanisms exist, which exclude any danger to persons or machinery through improper pressurisation.
- the system is only operated in perfect operative condition.
- the manual are always available in readable condition and complete at the place where the system is.
- the system is operated, serviced and repaired only by staff which is authorised and qualified to do so.
- the operator of the system receives regular instructions on all pertinent questions of industrial safety and environmental protection and knows the operating instructions and especially the safety notices contained in it.

### 2.2 General safety notices



**A condition for trouble-free and safe operation of this system is proper transport, proper storage, installation, assembly and proper use as well as careful operation and maintenance at regular intervals.**

**Any other operation than the one described in the following instructions is contrary to regulations and must therefore be excluded.**

**The CPC8000 always has to be handled with the care required for an electronic precision instrument (protect from humidity, impacts, strong magnetic fields, static electricity and extreme temperatures, do not insert any objects into the instrument and its openings).**

**The system is fed via the mains cable with a voltage which is dangerous for human beings. Even after disconnecting the instrument from the mains dangerous voltages can temporarily occur due to capacities.**

**Although the contacts of the integrated relays located at the back of the instrument are only approved for small electric powers, dangerous voltages or currents can occur at them in the case of faults or failures.**

**In case of faults or failures, there might be aggressive media under extreme temperature and under high pressure or vacuum connected to the system. At each pressure connection medium under high pressure or vacuum can occur. Objects accelerated by gas pressure present a danger. Media that leak out of the instrument may be dangerous for human beings and the environment.**



Warning

At the back of the instrument there is a fan (movable part). At this location sufficient air circulation has to be provided for to ensure that the heat conducted to the outside can be transported off.

If the display is damaged, glass splinters may present a danger.

When working with or on the instrument the personnel has to wear suitable protective devices, such as safety glasses. In addition from 40 bar up ear muffs are required, if a danger to the user cannot be forestalled by other appropriate measures.

If faults cannot be repaired with the present operating instructions, the system must be put out of operation immediately and protected against unintentional re-starting. Furthermore, supervisors and authorised service personnel have to be informed immediately.



Notice

Repairs must only be carried out by the manufacturer. Interventions and changes of the system are not allowed.

Further important safety notices are to be found in the individual sections of these instructions.

## 2.3 Safety notices regarding operation



Notice

The system must only be operated by trained and authorised personnel who know the manual and can work according to them.



Warning

Before the system is pressurised the operator must check all connections and the system for any visible damage and make sure that the system and all associated components are in a faultless, fully functional state.

The system is designed only for the intended use. The technical specifications in these operating instructions must be observed. Any improper handling or operating of the system outside the technical specifications requires immediate shutdown and checking by an authorised WIKA service employee.

The pressure medium used must comply with the requirements specified in the operating instructions.

The supply pressure at the SUPPLY HIGH port always has to be set to a value which will not endanger the test item (DUT) connected to the TEST port.

Temperatures above 40 °C inside of the instrument may result in damage or malfunctions.

If the overpressure limit of the integrated sensors is exceeded, this can cause direct danger to persons due to bursting components or danger to



Warning

persons due to resulting fault currents. The instrument must be put out of operation immediately and the authorities concerned must be notified.

Pressure medium might escape abruptly under high pressure from the back side VENT port, TEST port, if applicable, and SUPPLY LOW port.

At the SUPPLY LOW port, pressure will be released abruptly when the present pressure is controlled down. At the VENT port, this is manually realised with the function "Measure/Vent" via the SETUP-menu point: Controller settings, or automatically forced by a switch-off of the instrument or in case of a power cut. This condition is also created by an entered set value of 0 and the "AutoVENT" function (in the same menu ) activated. The user must ensure that there are appropriate protection mechanisms in place to prevent any danger to persons, the system or the environment by leaking medium, strong generation of noise, etc. The respective environmental regulations are to be observed hereby.

As pressure is released at the back side via the pressure connections, it must be ensured that there are no persons at the back side and that the pressure is released via the pipeline without danger.

The limit values for current and voltage of the integrated relays must not be exceeded and the relays must not have any direct or indirect effect on critical processes. Furthermore it must be ensured that no hazardous situations can arise as a result of any failure of the relays.



### 3. Product description

#### 3.1 Proper use

The CPC8000 is a high-precision pneumatic pressure controller equipped with one or two precision pressure sensors and the control unit. All pressure ports are located at the back of the device.

The instrument can be used to generate a pressure at the TEST port with high precision (CONTROL-mode) or to MEASURE a pressure applied at the TEST port with high precision (MEASURE-mode).

If a barometric reference sensor is integrated, the type of pressure displayed can be changed via the SETUP-menu point: "sensor settings" from absolute pressure to gauge pressure. (Dual-Range controller with a firmware below V1.11.2 offer the change of the pressure type only via interface.)



Warning

**Only dry clean air or nitrogen as pressure medium are allowed. Shop air should be avoided and dangerous media according to article 2 paragraph 2 of the 67/548/EC directive must be strictly avoided as pressure media. The maximum permissible supply pressure at the SUPPLY HIGH port should only be all little higher than the full scale value of the controller (see chapter: "3.9 Technical Data").**



Notice

Preferably the same pressure medium should be used which was used for the calibration as pressure media (see enclosure: calibration certificate).



Warning

**The technical specifications of the individual pressure sensors indicated, as well as all the other technical specifications mentioned in these manual, must be observed without exception.**

**Very fast pressure changes endanger the sensor, because they produce an extreme mechanical stress on the sensor; especially if the fast pressure change leads to an internal pressure which is higher then the full scale of the controller (even if it is only for a fraction of a second). In this case a protection by the integrated overpressure protectors cannot be guaranteed, because they require a certain response time before they are activated.**



Notice

All integrated pressure sensors have, unless agreed otherwise, a calibration certificate (see enclosure: calibration certificate) for the entire measuring chain. If the system is handled improperly or if the technical specifications mentioned in these operating instructions are exceeded, re-calibration or even an adjustment will be necessary.



Warning

**The system is not suitable for use in areas with an explosion hazard. The CPC8000 is not a safety component as defined by the pressure appliance guideline and must not be used as such. If the CPC8000 is not used according to these manual, safe operation of the system is not guaranteed.**

**The user of the system and not the manufacturer is responsible for all personal and material damage resulting from improper use!**

# High-Precision Pressure Controller CPC8000

## 3.2 Structure

The high-precision pressure controller CPC8000 consists of the main components of one or two high-precision pressure sensors protected by one or two safety valves, a control and evaluation unit, three or four solenoid valves, display, membrane keyboard, RS-232 and IEEE-488.2 interface, internal temperature probe, fan, eight relays (five used for internal tasks and three free programmable) and the housing which is available as stackable desk top model or 19" plug-in case. A barometric reference is available as an option.

### Front:

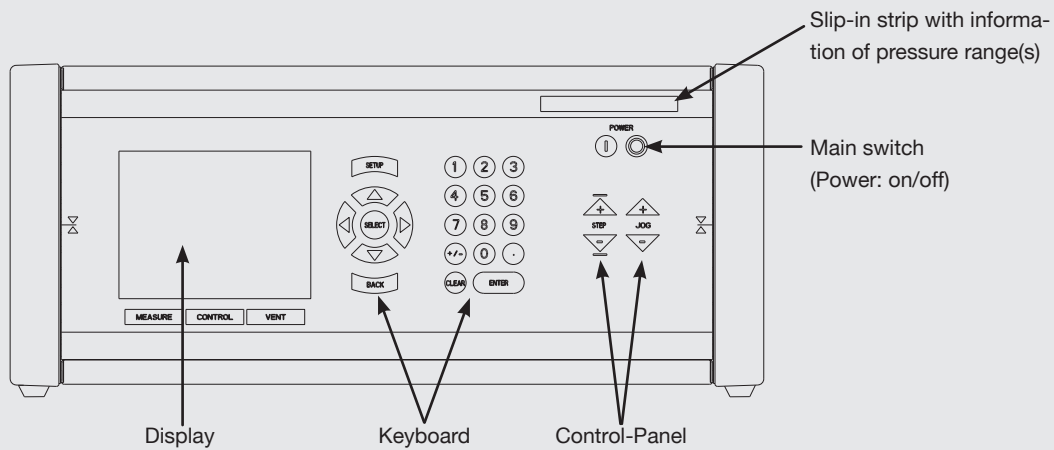

### Rear view:

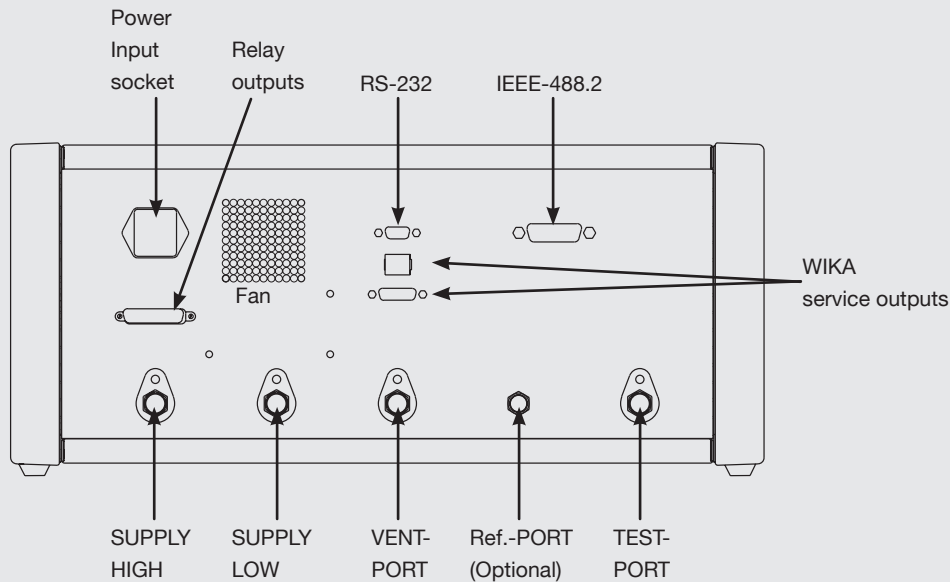

These illustrations show a desk top model

## 3.3 System concept: Single range Controller CPC8000-X/-L

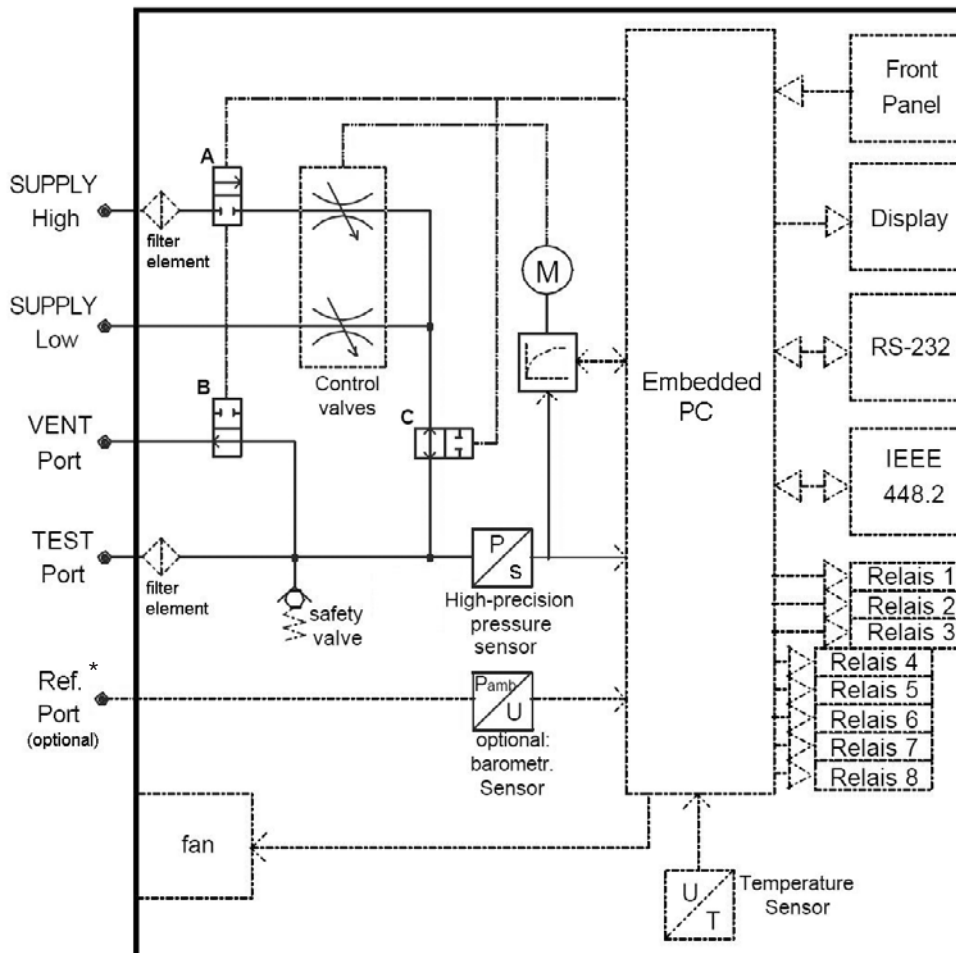

Operative diagram and pneumatic plan

\* Optional also all reference ports from the high-precision pressure sensors  $\leq 4$  bar are connected to this port.

### Connection-table regarding the pressure ports

SUPPLY HIGH	SUPPLY LOW		VENT Port	TEST Port	Ref. Port
Pressure supply (see: chapter Technical Data)	control-ranges $\geq 0$ bar atmosphere	control-ranges $\leq 0$ bar vacuum	atmosphere	test item	atmosphere

### Status-table of solenoid valves

Valve	A SUPPLY HIGH (NC)	B VENT Port (NO)	C Valves/Sens (NO)
MEASURE-mode	closed	closed	closed
CONTROL-mode	open	closed	open
VENT-mode	closed	open	open
Powerless	closed	open	open

## 3.4 System concept: Dual range Controller CPC8000-DX/-DL

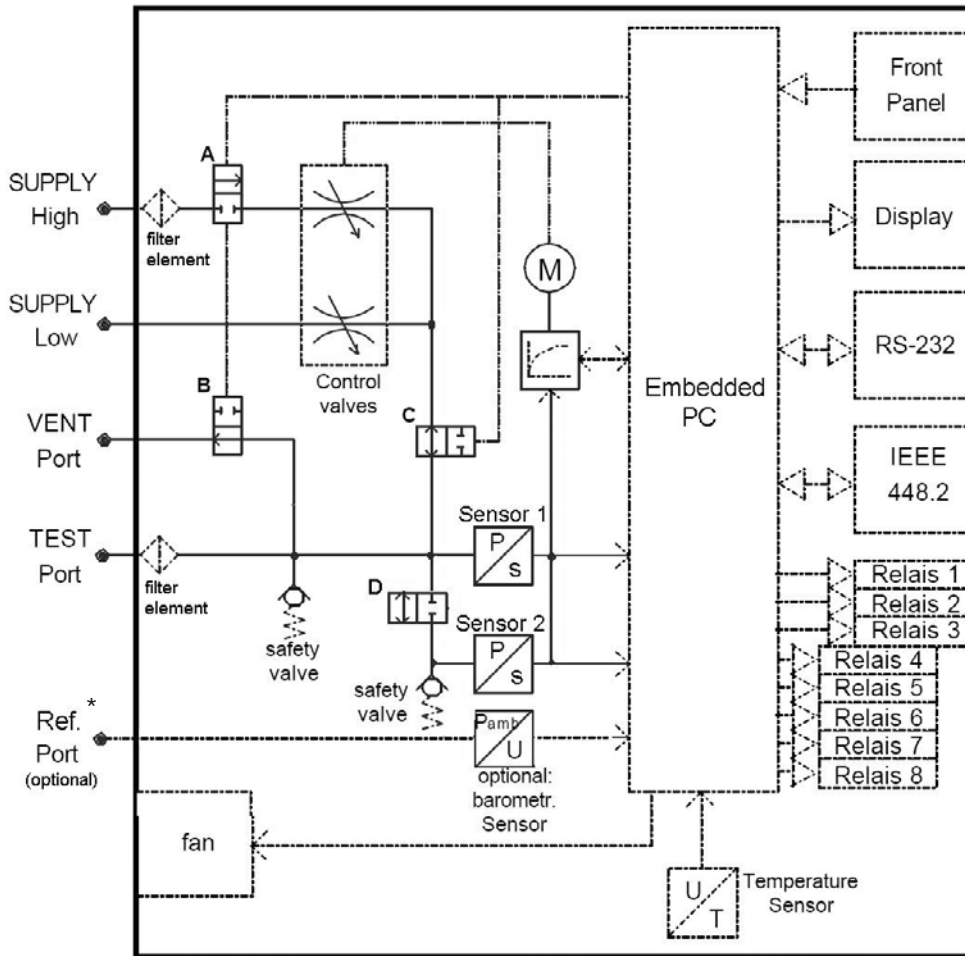

Operative diagram and pneumatic plan

\* Optional also all reference ports from the high-precision pressure sensors  $\leq 4$  bar are connected to this port.

### Connection-table regarding the pressure ports

SUPPLY HIGH	SUPPLY LOW		VENT Port	TEST Port	Ref. Port
Pressure supply (see: chapter Technical Data)	control-ranges $\geq 0$ bar atmosphere	control-ranges $< 0$ bar vacuum	atmosphere	test item	atmosphere

### Status-table of solenoid valves

Valve	A SUPPLY HIGH (NC)	B VENT Port (NO)	C Valves/Sens (NO)	D Sensor 2 (NC)
MEASURE-mode	closed	closed	closed	automatic**
CONTROL-mode	open	closed	open	automatic**
VENT-mode	closed	open	open	automatic**
Powerless	closed	open	open	closed

\*\* On/Off state depending on the current pressure and the working mode (see chapter: Dual range version of the CPC8000).

## 3.5 General functional description

The CPC8000 has 3 operating modes:

- CONTROL mode: A given pressure is generated at the TEST port with high precision  
Activation via: CONTROL key (key located directly under the display)
- MEASURE mode: A pressure applied at the TEST port is measured with high precision  
Activation via: MEASURE key (key located directly under the display)
- VENT mode: The system will be vented automatically  
Activation via: VENT key (key located directly under the display)  
(for pressures > 10 bar the pressure will be first controlled down to approx. 10 bar and then vented)

In both operating modes CONTROL/MEASURE the system can be manually vented via the VENT port by means of the VENT function at any time (a connection is established between TEST port and VENT port and the control valve is isolated from the pressure supply). The instrument also takes on this status in the case of power failures, overpressures or it is switched off.



**Through the VENT function the pressure build-up in the system will abruptly be released via the VENT port**

The controller is equipped with one or two precision sensors for gauge pressure or absolute pressure. If a barometric reference sensor (option) is integrated, the type of pressure can be changed between absolute pressure and gauge pressure.

With the help of the self-explanatory menu guide the measurement display can be configured in many ways, various functions can be called up, and measured data can be saved or communicated to other appliances via the interfaces (RS-232 and IEEE-488.2).

3 of the 8 integrated relays allow manual or pressure-related switching on/off of electrical loads. The contacts are designed as changeover contacts and can be assigned freely to the sensors. The switch points can be chosen freely and are to be keyed in via the keyboard. The integrated temperature sensor offers the user the possibility of checking the internal temperature of the system and to activate the integrated fan.

All important parameters and conditions are shown clearly on the display.

### Display with one window

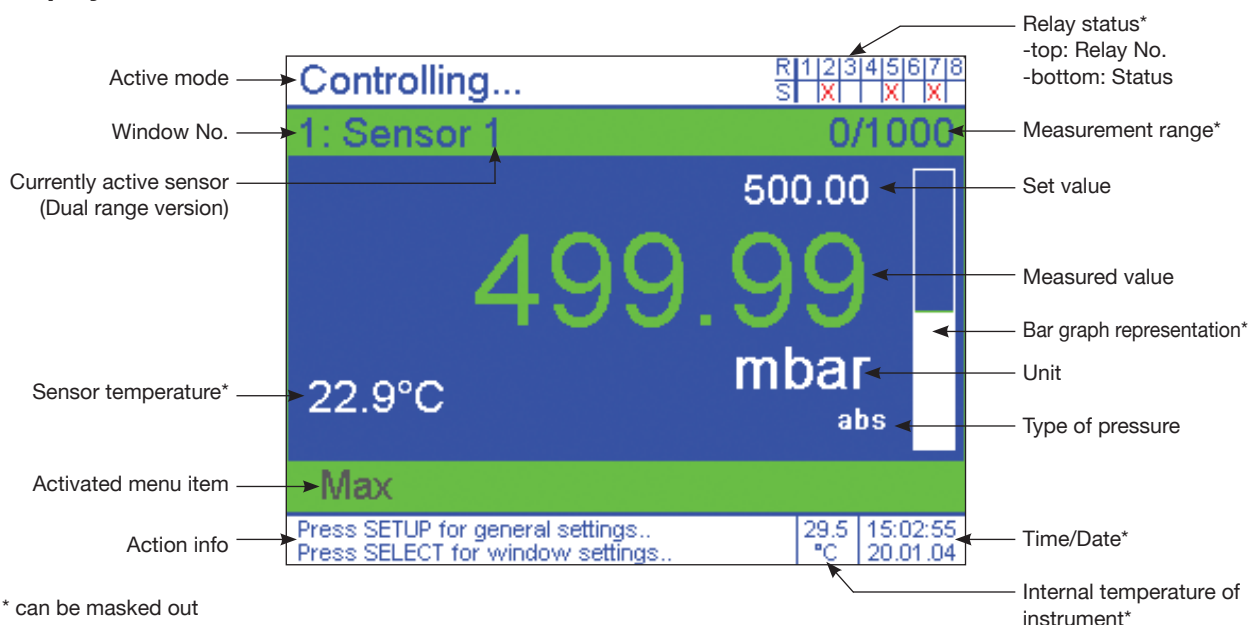

# High-Precision Pressure Controller CPC8000

If the CPC8000 is controlling a certain pressure and the current pressure value is in tolerance the colour of the measured value displayed on the screen will change from white into green (the default value is depending on the CPC8000 version and via the SETUP-menu point: Controller settings programmable). If in MEASURE-mode the measurement leaves the permissible range of the sensor, the value is shown in red instead of white figures. At the very top and the very bottom of the screen there is an area in white in the form of a beam which is independent of the number of windows and which will always be shown. In the upper white beam on the left the mode that is just active will be shown, and in the lower white beam on the left information related to further operation will be shown. On the right the relay status bar (top) and the temperature inside the appliance, the date and real time (bottom) can be faded in or out.

## Display with 2 windows

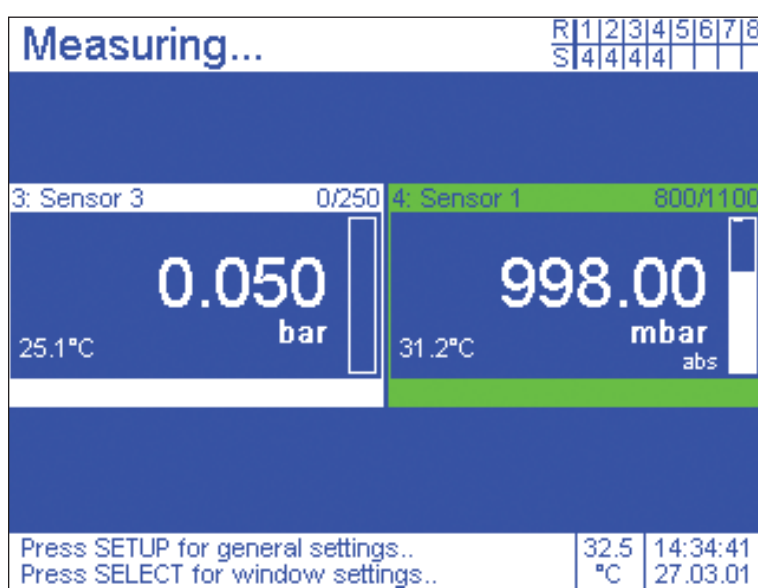

## Display with 4 windows

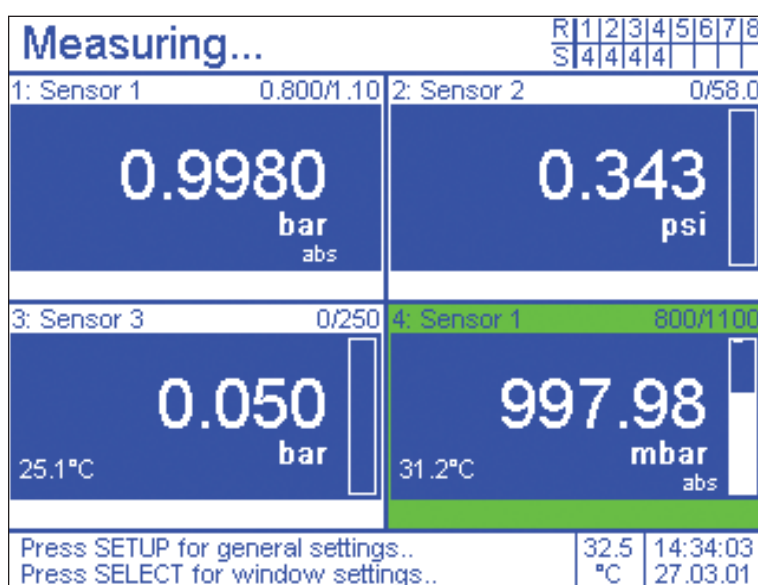

## 3.6 General notices regarding interface communication

For the description of the interface communication see Enclosure 2, Chapter "14. Enclosure / 2. Interface communication".



Notice

If, for example, the unit for the data communication is changed via interface, this has no influence on the unit used on the display. But, on the other hand, the type of pressure, for example, can be changed between relative/absolute via interface on the display.

## 3.7 Specification of the Controller

The slip-in strip on the top right of the front of the system contains information about important ratings of the pressure sensors presently installed.

### I. Version of a single range controller CPC8000-L/-X

Pressure range and pressure type of the controller

Accuracy of the controller



### II. Version of a dual range controller CPC8000-DL/-DX

Pressure range and pressure type of sensor 1 (main sensor)

Accuracy of sensor 1

Pressure range and pressure type of sensor 2

Accuracy of sensor 2



Notice

If an optional barometric reference sensor is integrated, the type of pressure (absolute pressure  $\Leftrightarrow$  gauge pressure) can be changed.



## 3.8 Operating principle of a dual-range controller

A dual-range controller features a second sensor in addition to the main sensor (sensor 1) in order to improve the accuracy in the lower part of the pressure range.

Dependent on the required pressure the dual-range controller automatically and intelligently selects the proper measuring range, regardless of whether the set value was entered via membrane keypad or interface.

The precision pressure sensors are combined flexibly according to the requirements of the customer. In order to cover a wide calibration range it is even possible to combine 2 sensors with a factor of up to 1:10 regarding their ranges.

Pressure range of the controller in %

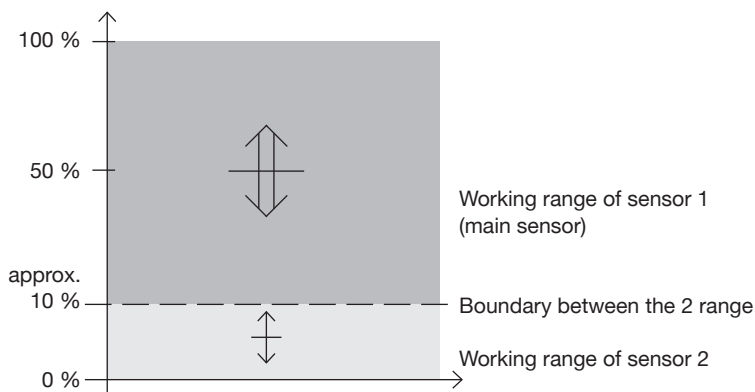

### Example of a changeover from one sensor to the other

a) starting point (start) in the working range of sensor 1 (main sensor)  
new pressure (target) in the working range of sensor 2

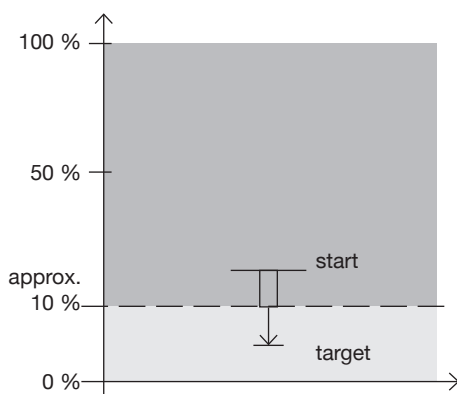

Changeover from sensor 1 to sensor 2 at the range boundary

b) starting point (start) in the working range of sensor 2  
new pressure (target) in the working range of sensor 1 (main sensor)

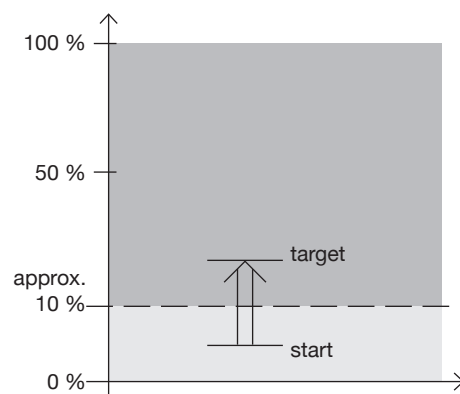

As soon as the control process for the new pressure is started, sensor 1 (main sensor) will be used as a reference, because the target is within the range of this sensor (sensor 2 will be not used in this case).



**Notice**

In the upper info line of the current window will be displayed, which sensor (1 or 2) is active.



# High-Precision Pressure Controller CPC8000

## 3.9 Specifications

### Specifications for the different pressure steps for CPC8000-L/-X

Pressure range for CPC8000-L/-X		CPC8000-L	CPC8000-X
<b>Low-Pneumatic Pressure Ranges</b>	<b>bar</b>	<b>0 ... 0.025 up to &lt; 1</b>	<b>0 ... 0,1</b>
Precision	%	0.005	0.004
Accuracy	%	0.01 FS	0.008 FS
Control stability	%	0.001	0.001
Slew rate	sec	< 20	< 20
<b>Standard Pneumatic Pressure Ranges</b>	<b>bar</b>	<b>0 ... 1 up to 60 *</b>	<b>0 ... 1 up to 60 *</b>
Precision	%	0.005	0.004
Accuracy	%	0.01 FS	0.008 IS <sup>1)</sup>
Control stability	%	0.001	0.001
Slew rate	sec	< 15	< 15
<b>High Pneumatic Pressure Ranges</b>	<b>bar</b>	<b>0 ... &gt; 60 up to 400 *</b>	<b>0 ... &gt; 60 up to 400 *</b>
Precision	%	0.005	0.005
Accuracy	%	0.01 FS	0.008 IS <sup>2)</sup>
Control stability	%	0.0012	0.0012
Slew rate	sec	< 25	< 25

{Absolute pressure range for CPC8000-L: 0 ... 0.4 bar up to 0 ... 16 bar and for CPC8000-X: 0 ... 1 bar up to 0 ... 16 bar \*}

\* For concretely available pressure ranges see current price list.

1) IntelliScale => % of measured value in the upper 2/3 of the pressure range.

2) IntelliScale => % of measured value in the upper half of the pressure range.

### General specifications

### CPC8000-L/-X

Control range	% FS	0 ... 100
Test volume	ccm	50 up to 1,000 (without throttle; Leakage < 10 <sup>-3</sup> )
Pressure ports		6 mm SWAGELOK <sup>®</sup> tube fitting
Adapter		on request
Overpressure protection		safety valves, scaled to 120 % of FS
Instrument version		19" plug-in case (optional: desk top)
Screen		TFT-Colour graphics display (320 x 240 Pixel)
Screen division	windows	1, 2 or 4
Indication of measured values	digits	up to 7
Measuring rate	values/sec.	8
Keyboard		Membrane keyboard
Evaluation unit		Motorola 50 MHz Power PC-Board
Operating system		Windows CE
Digital interface		RS-232 and IEEE-488.2
Relay outputs		3 programmable change-over contacts (potential free)
Power supply		AC 230 V ± 10 %, 50/60 Hz; 0.75 A (optional: AC 115 V)
Permissible pressure		
Supply High Port		
■ < 1 bar gauge pressure		approx. 2 bar (because a pressure regulator is integrated)
■ 1 ... 100 bar gauge pressure		approx. 110 % FS
■ > 100 bar gauge pressure		approx. 100 % FS + approx. 10 bar
■ Test Port	% FS	max. 120
Permissible		
■ Media		clean, dry air or nitrogen
■ Operating temperature (ambiente)	°C	15 ... 35
■ Storage temperature	°C	0 ... 70
■ Air humidity	%	35 ... 85 relative humidity without moisture condensation
Ingress protection		IP31 (front panel IP41)
Weight	kg	approx. 17
Dimensions		see technical drawings
CE-mark		conformity certificate
Calibration <sup>3)</sup>		Incl. calibration report 3.1 according to DIN EN 10 204

3) Calibration in a horizontal mounting position.

## 4. Installation

### 4.1 Introduction

In this chapter information for the initial installation of the CPC8000 can be found. The installation of the CPC8000 is done as follows: Unpack the system, install it in a suitable place, connect it, switch it on and configure the system with the operating field.

### 4.2 Unpacking of the system

Unpack all components of the appliance carefully and check the parts for damage. Report any damage immediately to the forwarding agent.

Apart from any additional components ordered, a shipment consists of:

- Basic system
- Main cable
- Manual with calibration certificates in the enclosure
- Optional: recommend Interface cable

### 4.3 Dimensions of the available version in mm

#### Desk top model:

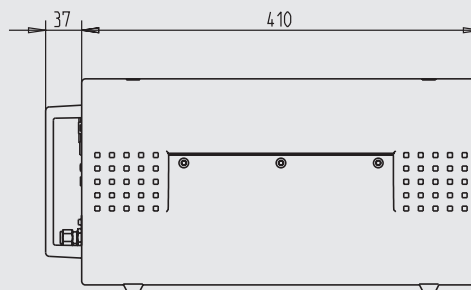
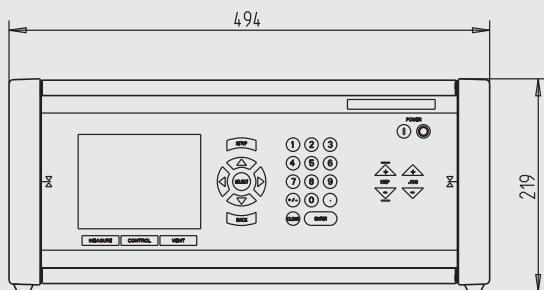

#### 19" plug-in case:

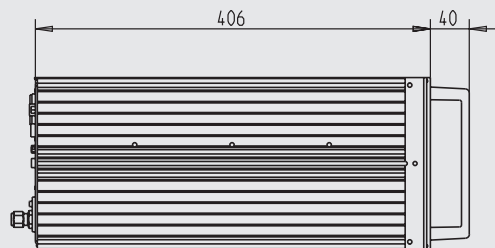
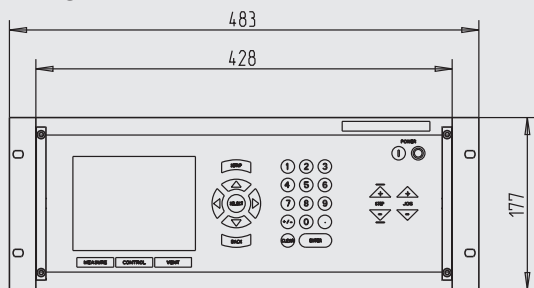

### 4.4 Installation of the system

#### The place of installation must meet the following conditions:

- Ambient temperature: 15 to 35 °C
- Humidity: 35 to 85 % relative humidity without dewing
- Flat, horizontal location; secure fixed working surface (desk top model) or proper installation in a sturdy 19" mounting frame / 4HE (19" plug-in case)
- At the back of the instrument sufficient air circulation must be provided for to avoid an accumulation of the heat conducted to the outside via the fan.
- As during operation pressure escapes at the back, it has to be ensured that during operation nobody has access to the back of the instrument or, if the VENT / LOW SUPPLY ports are pipe-connected, to the VENT opening of the pipes.

#### Avoid the following influences:

- Direct sunlight or proximity to hot objects
- Unstable installation position
- Mechanical vibration
- Proximity to sources of interference with strong electromagnetic fields, such as high tension appliances, mobile telephones or mains
- Soot, steam, dust and corrosive gases
- Environment with explosion hazard, inflammable atmospheres

#### Pressure supply requirements:

- Stable supply pressure only a little bit higher than the full scale of the controller (see chapter: "3.9 Technical Data")
- Permissible media: dry, clean air or nitrogen
- Vacuum: min. 50 litres/min (if required)



Notice

Up to 3 desk top models can be stacked on each other.

An angle of inclination of the system of more than 3 degrees has a negative effect on the measuring result and must be avoided.

## 4.5 Pressure connections



Warning

The pressure connections must be installed according to the following instructions, observing the relevant regulations. The installation is to be carried out by persons familiar with, and who can work according to, the safety regulations for working on pneumatic/hydraulic plants.

### Rear view

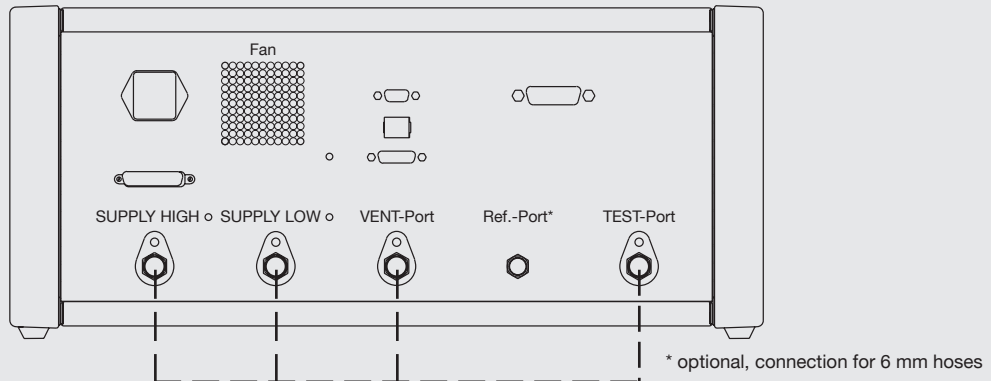

### Optional Adapter

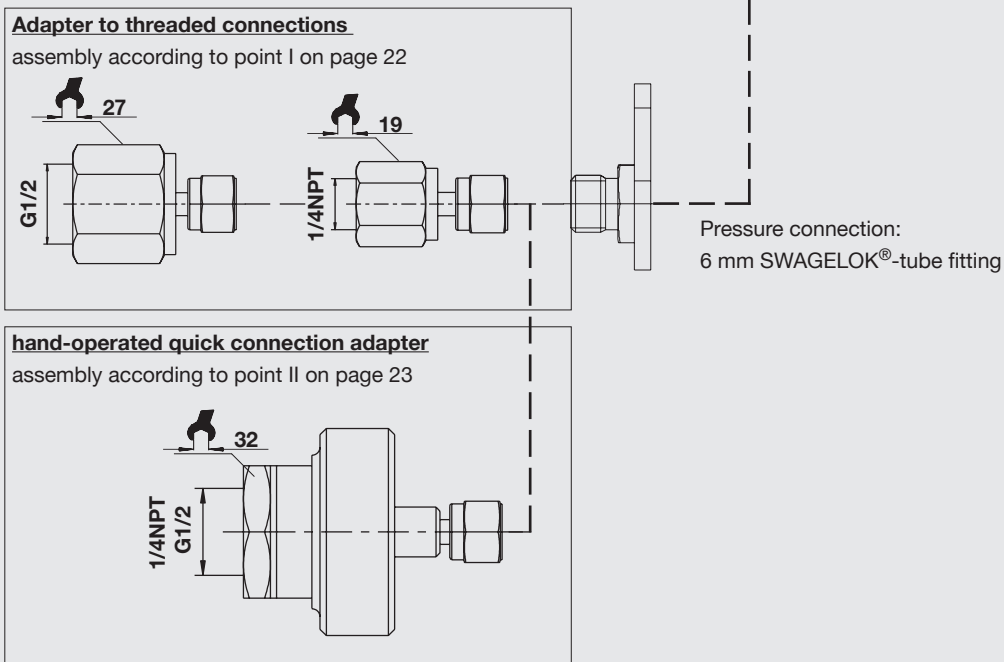

Notice

Up to 5 pressure connections are at the instruments back. Pressure connections that are not assigned are provided with blind plugs. The optional Ref.-port must left open to atmosphere pressure and should never connected to an external pressure source.



Warning

**Blind plugs, instead of pressure connections, are only to be loosened or removed by authorised WIKA service personnel.**

### 4.6 Notices regarding to pressure connections

At the back of the instrument, all pressure connections, beside Ref-Port, are specified as SWAGELOK® pipe connections with an outside pipe diameter of 6 mm.

The diameter of the pipework has to be selected according to length and pressure (see chapter: "4.7.1 Recommendation regarding the piping").

#### ■ TEST Port

The pressure connection is located underneath the marking "TEST port" at which in the CONTROL-mode the pressure that is precisely controlled by the controller is applied or at which in the MEASURE-mode a pressure applied is measured by the instrument with high precision.

#### ■ SUPPLY HIGH Port

The pressure connection for the supply pressure of the controller is located underneath the marking "SUPPLY HIGH". The supplied pressure should only be a little bit higher than the fullscale of the controller (see slip-in strip on the upper-right of the front panel and chapter: "3.9 Technical Data").

#### ■ SUPPLY LOW Port

The pressure connection for the vacuum supply is located underneath the marking "SUPPLY LOW" (only for supply pressure < 40 bar); In a gauge pressure version the port can be left open to atmospheric pressure.

#### ■ VENT Port

The pressure connection is located underneath the marking "VENT" via which the system is abruptly vented to the atmosphere under certain conditions.

#### ■ REF. Port

If there is no blind plug at the port with the sign Ref., this is the connection to the optional barometric reference and to the reference ports of sensors with ranges  $\leq 4$  bar (gauge). This port has to be left open to the atmosphere and should never be connected to a pressure source.



**If a blind plug is not installed, the port (connection) with the description "Ref.:" is the connection with the optional barometric reference as well as with the reference port of pressure sensors with overpressure ranges of  $\leq 4$  bar.**

**This connection must be openly connected to the atmosphere and must not be pressurised by external pressure.**

**The user has to ensure that any medium that might escape from the VENT or SUPPLY LOW port is released in a suitable manner without danger to persons, the environment or the system. Moreover suitable silencer should be used.**

**The higher the supply pressure connected to the SUPPLY HIGH port (inlet port of the control unit) is, the higher the pressure which leaves the system through the SUPPLY LOW port (outlet port of the control unit).**

**If a vacuum pump is connected to the SUPPLY LOW port, adequate safety precautions have to be taken, so that the pump will not be damaged.**



Warning

Furthermore the supply pressure in its full height should not present any danger for the pump (therefore the technical data of the pump have to be checked before).

If vacuum is connected to the **SUPPLY LOW** port of the controller, negative pressure peaks of several -100 mbar might occur at the **TEST** port for a very short time, when changing from the **MEASURE-mode** to the **CONTROL-mode**.

After a reaction of the internal overflow valve we recommend immediately sending the system to the manufacturer for checking.

Before the system is connected, one must ensure that suitable protection measures are in place which exclude overloading of the test item or the system. The supply pressure at the **SUPPLY HIGH** port must never exceed the overpressure safety of the device under test.

The pressure pipes, couplings and other components used for tubing must be licensed for the occurring pressures.

The user must ensure that the respective pressure media are available in clean/pure form and should also be dry. If necessary, the sensors must be protected by using sediment bowls, particle filters or humidity filters.

### 4.7 Assembly of the pressure connections

First the protective plastic caps must be carefully removed from the **SWAGELOK®** connections. (Please keep the protective plastic caps for later use).

Pressure connection adapters which have also been ordered, are to be assembled according to the design as per points I. or II., otherwise see point III.

#### I. Tubing with a adapter from **SWAGELOK®** to threading

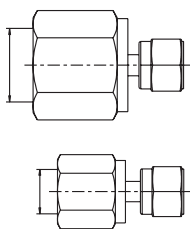

1. Connect the adapter tightly with the threaded connection (if necessary use suitable sealing material).
2. Connect the **SWAGELOK®** fitting of the adapter with the corresponding connection of the pressure sensor to be connected and tighten the nut "finger-tight".
3. Tighten the **SWAGELOK®** connection with a suitable spanner 1/4 turn.

#### **In case point 1 cannot be done first:**

1. Carry out points 2 and 3
2. Secure **SWAGELOK®** connection against twisting with a suitable spanner and screw down the threaded connection tightly (if necessary use suitable sealing material).

## II. Assembly of a hand-operated quick connection adapter

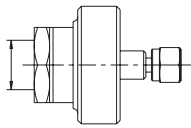

1. Push SWAGELOK® connection of the adapter into the corresponding connection of the measuring converter to be connected and tighten the nut "finger-tight".
2. Tighten the SWAGELOK® connection with a suitable spanner 1/4 turn.
3. Put on threaded connection and tighten "hand-tight" by turning the knurled nut.

## III. Tubing without adapter

The tubing without adapter is to be carried out by a fitter trained in SWAGELOK® connections according to SWAGELOK® tubing instructions.



Warning

**When working on a connection with a SWAGELOK® connection already fitted, one must prevent overturning or loosening this SWAGELOK® connection with a suitable tool.**



Notice

Leaky pipework may lead to a falsification of the measuring results. The leak tightness of the pipework can be checked by controlling a permissible pressure with the test assembly being completely set up and then pressing the CONTROL OFF-key (MEASURE-mode). A fast pressure drop in the MEASURE-mode points to a leak in the pipework.

## 4.7.1 Recommendation regarding the piping

The user has to ensure that any released medium does not endanger any person, environment or the instrument.

Below are recommendations regarding the piping.

### Rear view

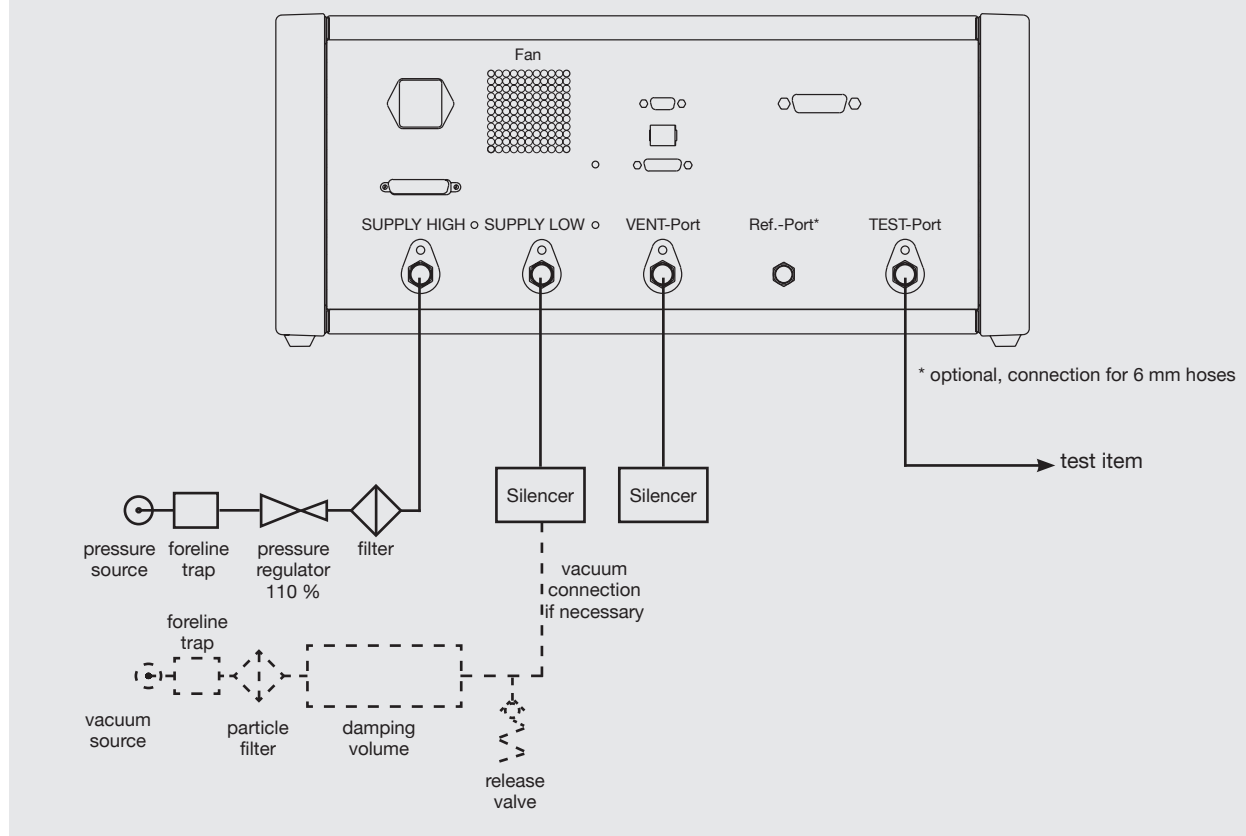

### Recommended diameter of the piping:

SUPPLY HIGH & TEST port:

up to a length of 1.5 m:  $\varnothing$  min. 4 mm

lengths from 1.5 up to 3 m:  $\varnothing$  min. 6 mm

SUPPLY LOW:

when vacuum is necessary: use corrugated vacuum tube



Notice

Especially if test items with great volumes (like precision test gauges) are used, then long and thin piping have a negative effect on the control performance.



## 4.8 Electrical connections



Warning

The electrical installation has to be carried out according to the following instructions while observing the relevant regulations. It is to be carried out by persons familiar with the safety regulations for working on electrical plants and who can work according to them.

### Rear view

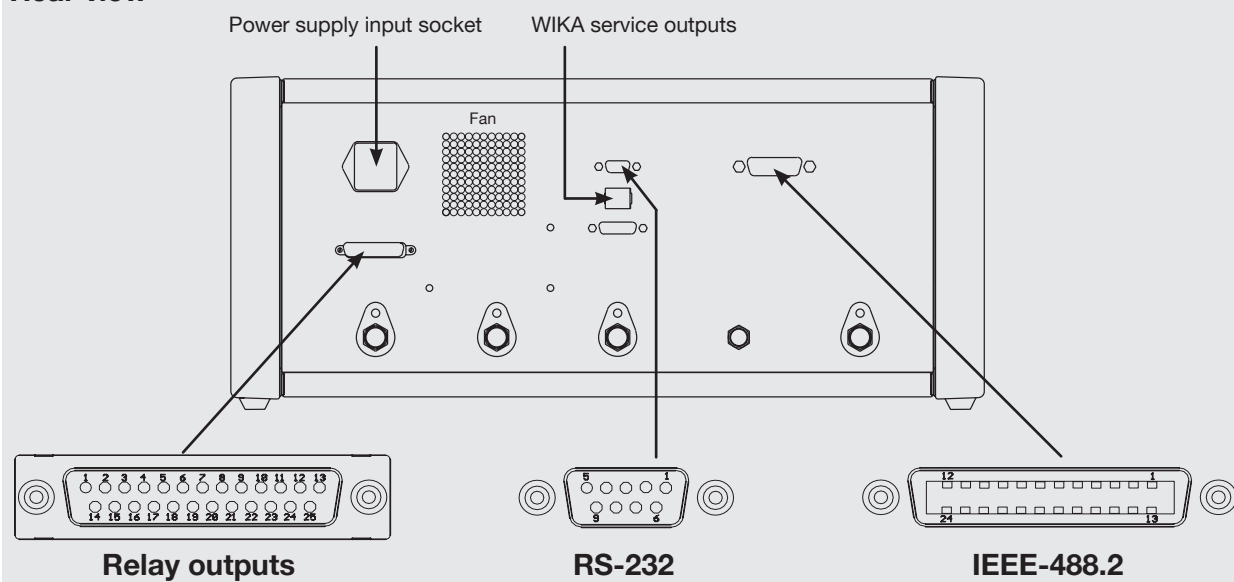

25 pole SUB-D-plug

9 pole SUB-D-socket

24 pole IEEE-488 socket

#### PIN-configuration

1	┌──┐	changeover-contact 1
2		
3		
4	┌──┐	changeover-contact 2
5		
6	┌──┐	changeover-contact 3
7		
8		
9	┌──┐	contacts should not be used
10		
11		
12		
13		
14		
15		
16		
17		
18		
19		
20		
21		
22		
23		
24		
25		

#### PIN-configuration

internal bridge	1:	CD
	2:	RxD
	3:	TxD
	4:	DTR
	5:	GND
	6:	DSR
	7:	RTS
	8:	CTS
	9:	NC

#### PIN-configuration

1:	DIO1	13:	DIO5
2:	DIO2	14:	DIO6
3:	DIO3	15:	DIO7
4:	DIO4	16:	DIO8
5:	EOI	17:	REN
6:	DAV	18:	GND
7:	NRFD	19:	GND
8:	NDAC	20:	GND
9:	IFC	21:	GND
10:	SRQ	22:	GND
11:	ATN	23:	GND
12:	SCHIELD	24:	GND

### 4.9 Notices regarding the electrical connections

#### 4.9.1 Connection of the power supply



Warning

**Before connecting the power supply, make sure that the mains voltage agrees with the specification of the power unit. Switch off the system before connecting the mains. Only the mains cable supplied should be used.**

**The 3-pole mains cable supplied is fitted with an earth lead. You should therefore operate the system only from a three-pin socket and always make sure that the earth lead is properly connected.**

The mains input socket is to be connected according to the regulations with the countryspecific connection cable supplied to a power supply that lies within the required specification (see chapter: "3.9 Technical Data" and type label)

#### 4.9.2 Connection of the interfaces



Warning

**The interface cables must not be longer than 3 m and must be laid separate from cables with voltages > 60. Instruments which are connected to the interfaces have to comply with the standard IEC 60 950.**

#### RS-232 Interface

The RS-232 interface is designed as a 9 pole SUB-D-socket (PIN-configuration see "4.8 Electrical connections") and is to be connected as required according to the regulations with the cable mentioned below or a 9 pole 1:1 cable of similar quality:

- **3 m Data Extension Cable; DB9 Male/DB9 Female; No. 316170 of the company KCLICK®**

#### IEEE-488 Interface

The connection of the IEEE-488 interface is designed as a 24 pole IEEE-488-socket (PIN-configuration see "4.8 Electrical connections") and is to be connected as required according to the regulations with the cable mentioned below or of similar quality:

- **2 m IEEE-488-2-MPB CABLE of the company GTK® Gold-TekElectricCoLtd**

#### 4.9.3 Connection of the relay outputs



Warning

**When connecting the relay outputs the national installation regulations (Germany: VDE standard) and the Appliance Safety Law are to be observed and followed.**

**The limits of the relays for current and voltage must not be exceeded and the relays must not have any direct or indirect effect on critical processes.**

Only the first 9 contacts with a output capacity: **max. 1 A / 30 V DC of the relay outputs** (25 pole SUB-D plug) can be used by the user (3 potential-free changeover contacts; PIN-configuration see "4.8 Electrical connections"). All the other contacts are not allowed to use.

## 4.9.4 Connection of the WIKA service outputs



Warning

The WIKA service outputs cannot be used by anyone but authorised WIKA service personal using special connection cables. Any attempts to make use of the service outputs will void your rights to claim anything under guarantee.

## FOR YOUR NOTES

**FOR YOUR NOTES**

## 5. Starting operation



Warning

**Before the system is switched on, one must make sure that the system was installed according to the instructions of the previous chapter and that all connections installed are fitted or carried out according to the current regulations.**

**One must ensure that all specifications such as supply voltage, operating temperature, humidity, sensor-specific pressure media and pressure ranges are observed.**

**Condensation can occur inside the system when the temperature changes quickly. Give the system sufficient time for acclimatisation in such cases.**

**Before pressurising, one must ensure through appropriate protective measures that the system or the test piece will not be overloaded. When working with or on the instrument, safety glasses have to be worn. When the supply pressure exceeds 40 bar, ear muffs are required.**

**In the rooms in which the CPC8000 is operated sufficient air ventilation has to be ensured, as these might escape, when working with inert gases.**

When the above points have been met you can switch on the system, optimise it to the operation conditions via SETUP-menu point: Controller adaption and configure it as required after you have familiarised yourself with the operation (see chapter: "6. Operation").



Warning

**High Pressure can accelerate loss parts in a manner, so that they will present a danger for persons or other things.**



Notice

The system is configured ex factory in such a way that the individual measurement representation (1 window/MEASURE-mode) will appear on the screen.

As soon as the thermal equilibrium between the controller and its ambience is accomplished, the controller is ready for operation. However, in order to achieve an optimal precision of the system, the instrument should be switched on 15 min. before use.

An optimal operation can only be guaranteed, if the autom. Function: Controller adaption of the SETUP-menu (chapter: " 6.9.1 SETUP-menu point: Controller adaption") is used.

The "controller adaption" function offers also the possibility to work with a reduced supply pressure (< 100 %).



Warning

**Extremely fast pressure change rates represent a danger to the sensor/s.**

## 6. Operation

### 6.1 Elements of the membrane keyboard

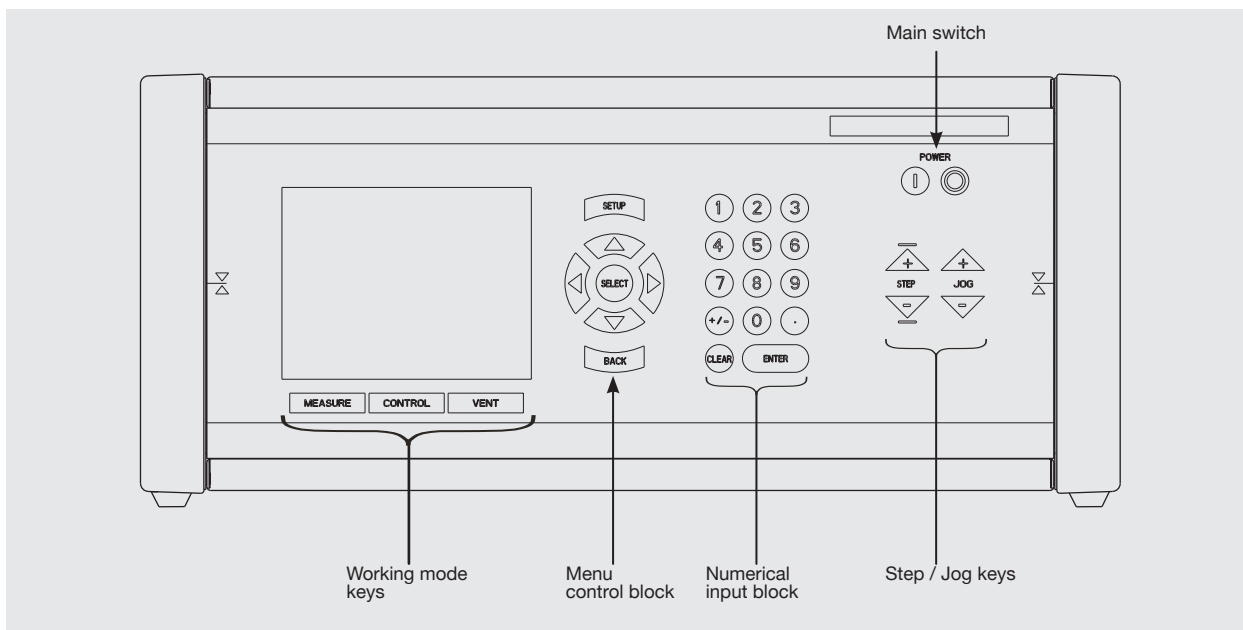

Key board element	Function
Main switch	Switching the system on/off (left: On; right: Off)
Working mode keys	CONTROL = Control mode; MEASURE = Measure mode; VENT = Vent mode
Menu control block	Navigation within the menu, calling-up of menu points, activation/deactivation of functions or menu points and running through stored lists (a comprehensive description of the individual keys can be found on page 31)
Numerical input block	Keying-in of numbers in input fields (a comprehensive description of the individual keys can be found on page 32).
STEP / JOG key	Change of the set value via STEP and JOG function (see page 33 for a detailed description of the individual keys)



#### Notice

After the system is switched on, and after the subsequent auto-test, the device is in the last saved measurement display mode (1, 2 or 4 display windows). The instrument should not be switched off during booting (approx. 8 sec.) or saving.  
After the system has been switched off one should wait for about 5 sec. before switching it on again.

## 6.2 Functional description of the menu control block



The SETUP-key is only used for calling-up the SETUP-menu (General Settings) and can only be called when the MEASURE or CONTROL-mode is active.

key	surface/field	Menu surface	scroll field	Data input field formatted number	Name/Text
		Movement to the right	no effect	one position to the right (unless already at the right edge)	
		Movement to the left	no effect	one position to the left (unless already at the left edge)	
		Movement to upwards	run through the stored List ascending (ring shift)	0 - 9	A - Za - z 0 - 9.:,/°) ascending (ring shift)
		Movement to downwards	run through the stored List descending (ring shift)	0 - 9	A - Za - z 0 - 9.:,/°) descending (ring shift)
		<u>in measuring mode</u> : call of the respective Window-menu <u>In SETUP-menu and in Window-menu</u> call of the menu point <u>on selection field</u> confirmation of the selection <u>on switchover field</u> in-/activation	1st time: input activation 2nd time: input confirmation		
		back to the next higher level	Cancellation of the input and the input is not taken over		

The current position is marked by colour: green in a menu surface and white in a data input field

## 6.3 Description of the keys for selecting the working mode

The working mode can be selected by using the keys located just below the display.

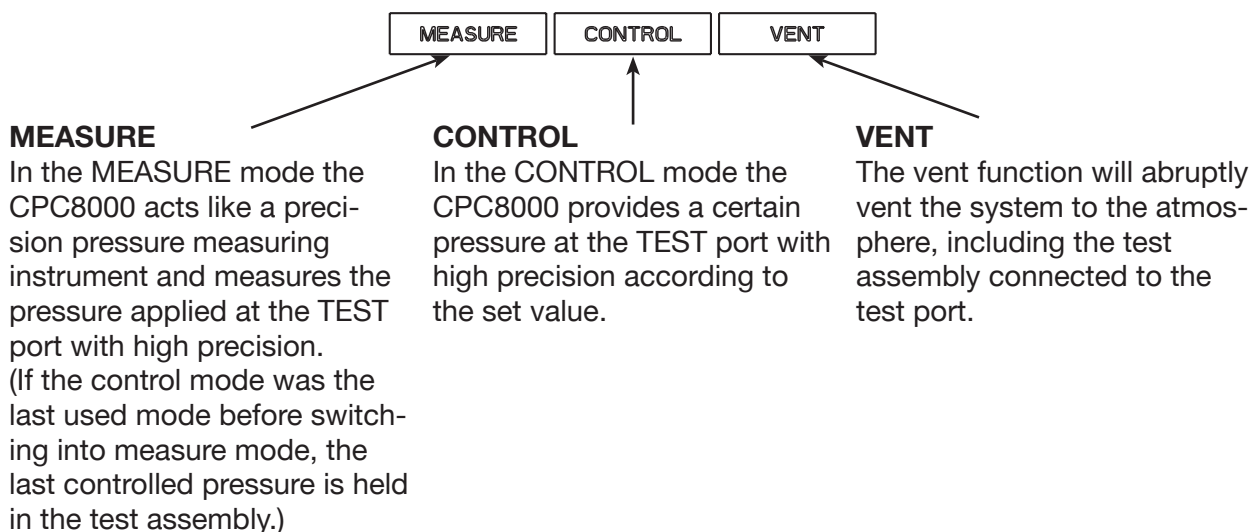

## 6.4 Functional description of the numerical input block

The numerical input block can be used for the input of the control set value or for the input of numbers and values within input fields. (The input must have been activated before by pressing the SELECT-key).

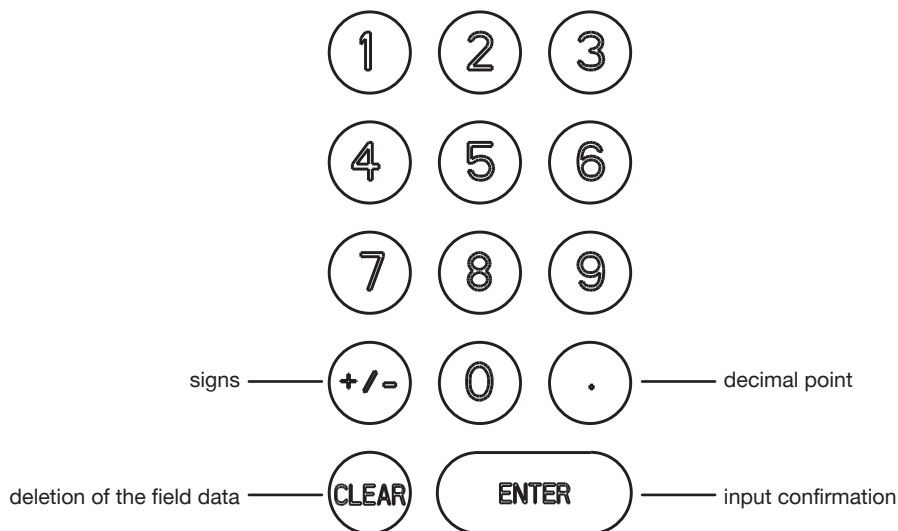

Notice

Number input fields are normally formatted, so that the digits and existing decimal point are pre-set. After keying in a number within an input field the cursor will automatically jump one digit to the right (except for the digit at the very right).

If one leaves an input field with the BACK-key, the input is not taken over.



## 6.5 Functional description of the control function block

The set value can be changed stepwise via the STEP and JOG-keys.

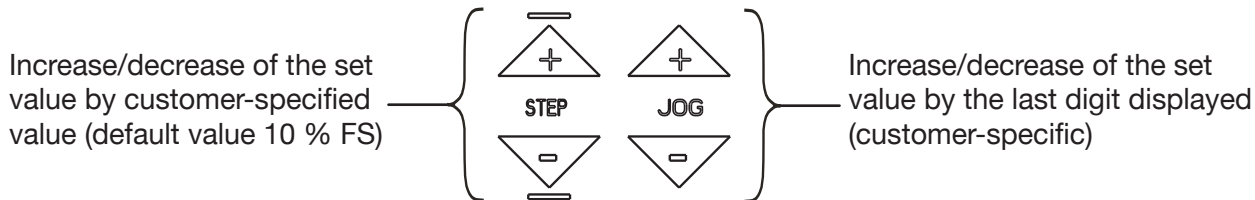

## 6.6 Structure of the menu guide

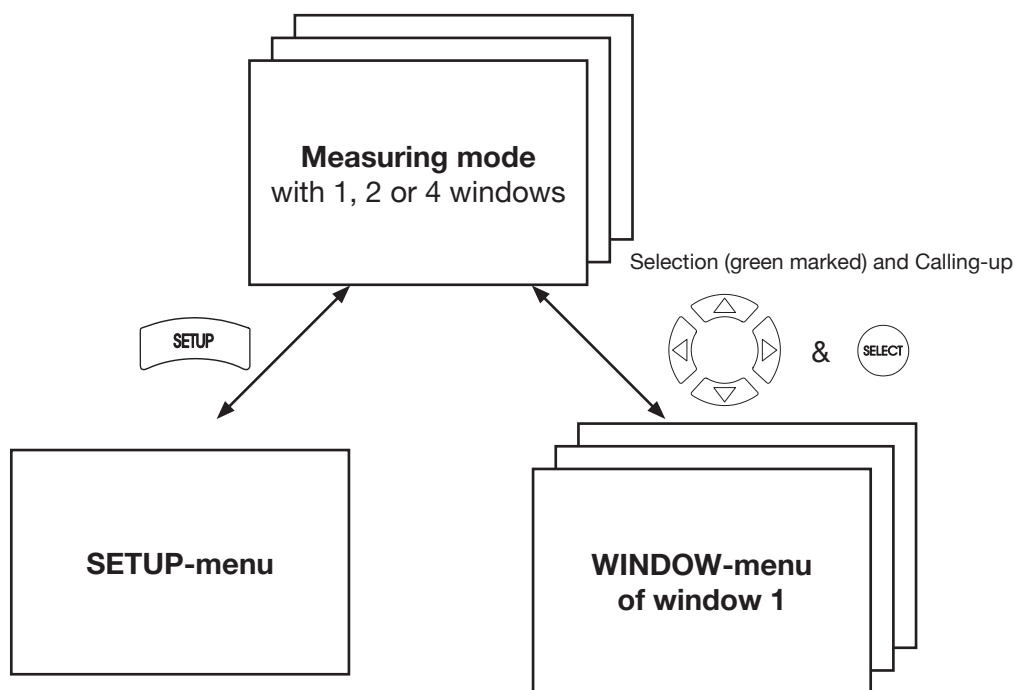

Starting from the measuring or controlling mode one gets (SETUP or SELECT-key) into the:

- **SETUP-menu**

for general settings of the system/configurations which concern all windows.

or

- **WINDOW-menu (one for each window)**

for activating functions and the configuration of the measurement representation/configurations tied to windows.



**Notice**

The current mode is always shown on the top left of the screen. For each sub-list level the name of the mode is preceded by a dot.

## 6.7 Operating modes: MEASURE-mode, CONTROL-mode and VENT-mode

The CPC8000 has three operating modes: MEASURE-mode, CONTROL-mode and VENT-mode. They are the highest level of the operator guidance.

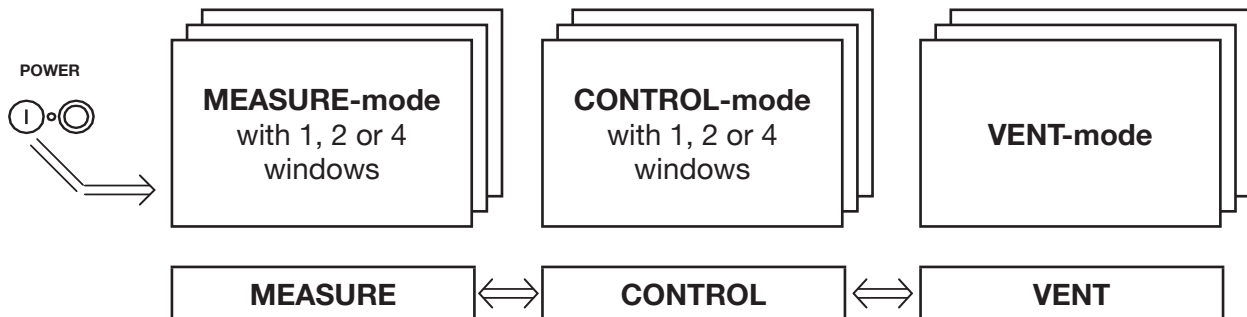

After the system has been switched on, and after a subsequent short self-test the instrument is automatically in the **MEASURE-mode**. The switching from one mode to another is done by using the working mode keys located just below the display.



### Notice

When switching from the CONTROL-mode to the MEASURE-mode, the system is not ventilated, instead the last applied pressure is locked in the system by means of solenoid valves.

From both modes it is possible to access the SETUP-menu via the SETUP-key or a windows menu via the SELECT-key in order to carry out general or specific settings as listed below (see chapter "6.8 Menu tree").

Although the integrated pressure sensors have an excellent long-term stability, the zero point may be corrected via "SETUP-menu item: Sensor settings", if required. It is recommended to reset the zero point every three months.

In both modes it is possible to view 1, 2 or 4 windows on the screen simultaneously via the "SETUP-menu item: Number of windows". This enables for instance the simultaneous representation of the measured value in various pressure units or the additional, parallel calling up of a function (min, max, etc.).

When a barometric reference sensor (option) is integrated, a switching between the absolute and gauge types of pressure is possible (Dual range controller with a firmware below V1.11.2 offer the change of the pressure type only via interface).

If required, the zero point of the calculated type of pressure can be corrected via "SETUP-menu item: Sensor settings". This correction only has an effect on the calculated type of pressure, but not on the sensor signals themselves.

The type of pressure of the precision pressure sensors are stated in the "SETUP-menu item: INFO".

By using the VENT key, which is located directly under the display, the system is abruptly vented to the atmosphere through the VENT port. This is achieved by establishing a connection between TEST port and VENT port, so that pressure built-up in the system is controlled down to 10 bar and then is abruptly released via the VENT port.

Venting from CONTROL or MEASURE-mode through the VENT-key the controller further measures the current pressure after implemented action. However the controller is still in VENT-mode.

The following table shows the conditions under those the VENT and/or AUTOVENT function can be executed.

Function	Sensor-mode	
	abs	rel
VENT	✓	✓
AUTOVENT	-	✓

## 6.7.1 The MEASURE-mode

**Activated:** by pressing the MEASURE key.

In the MEASURE-mode the CPC8000 acts as a precision pressure measuring instrument and measures the pressure applied at the TEST port with high precision.

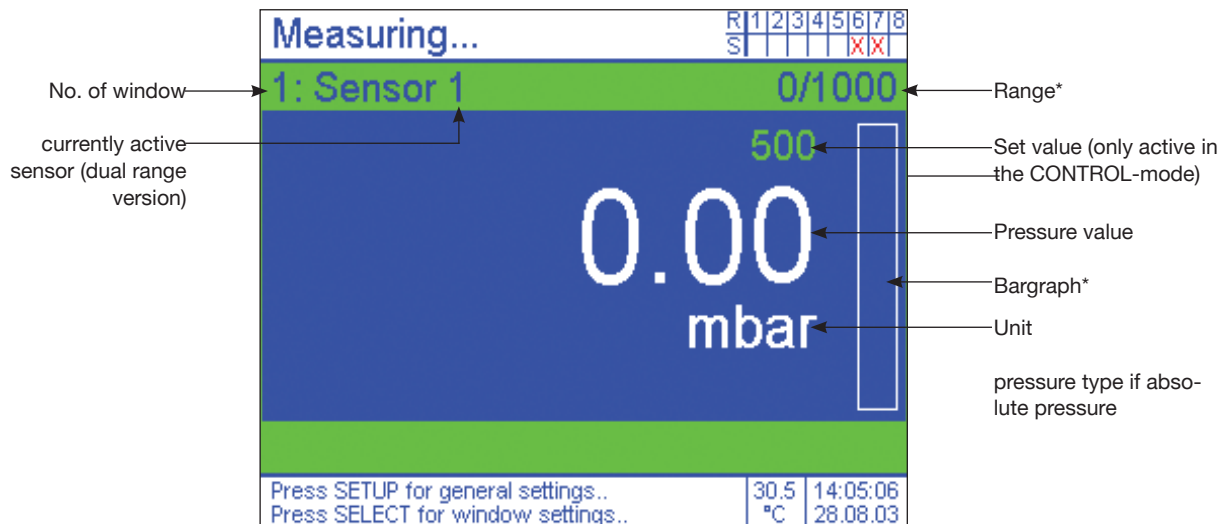

\* can be masked out

If the pressure value is beyond the permissible measurement range, it is displayed in red instead of white figures. As soon as a pressure of approx. 120 % FS is reached, an integrated safety valve opens and releases the pressure into the inside of the instrument.

The Set value may already be entered in the MEASURE-mode via the numerical input block.



Notice

During the input of the Set value (after entering the first digit) the representation colour is green instead of white. Before switching to another menu, the Set value input has to be completed by pressing the ENTER-key (confirmation of input) or the BACK-key (cancellation of input).

When the Set value input in the MEASURE-mode is completed and then the CONTROL-mode is activated by pressing the CONTROL-key, the CPC8000 starts to control the set value immediately.



Notice

To change from the CONTROL-mode to the MEASURE-mode the MEASURE-key has to be used.

## 6.7.2 The CONTROL-mode

**Activated:** by pressing the CONTROL key.

The **CONTROL-mode** can be accessed from the MEASURE-mode by pressing the CONTROL ON-key.

In the CONTROL-mode the CPC8000 acts as a precision pressure controller and provides a given pressure at the TEST port with high precision.

In order to ensure that the controller is correctly configured for the task it is supposed to perform, the following measures have to be taken and the respective parameters have to be set in the SETUP-menu (see chapter "6.8 Menu tree").

In order to control pressures close to or below atmospheric pressure, a vacuum pump has to be connected to the SUPPLY LOW port, and in the "SETUP-menu item: Control settings" the setting "autovent off" has to be selected. As the venting is carried out via the SUPPLY LOW port, it has to be ensured that the vacuum pump is not pressurised with an impermissibly high pressure.

In order to control pressures above atmospheric pressure, there may be ambient pressure at the SUPPLY LOW port and the setting "autovent on" in the "SETUP-menu item: Control settings" can be chosen. If "autovent on" is selected and the entered Set value is 0 bar, the controller will produce a connection between TEST port and VENT port (< 10 bar), in order to reach ambient air pressure very fast.

In order to achieve an optimal control performance the "SETUP-menu item: Controller adaption" have to be used.

Further via the "SETUP-menu item: Controller settings" the control speed can be set.

If the controller should be as fast as possible (without overshooting) the "Max. Slew Rate" is to be set to 100. For slow control applications such as pressure switch tests a lower value should be selected.

"Transient times constant" and "Damping factor" should only be changed in case to optimise the control behaviour when the operating conditions have been changed severely (never change it more than  $\pm 2$  digits).



Warning

**While a pressure source is connected to the TEST it is not allowed to switch from the MEASURE-mode into the CONTROL-mode or even to try to control a pressure.**

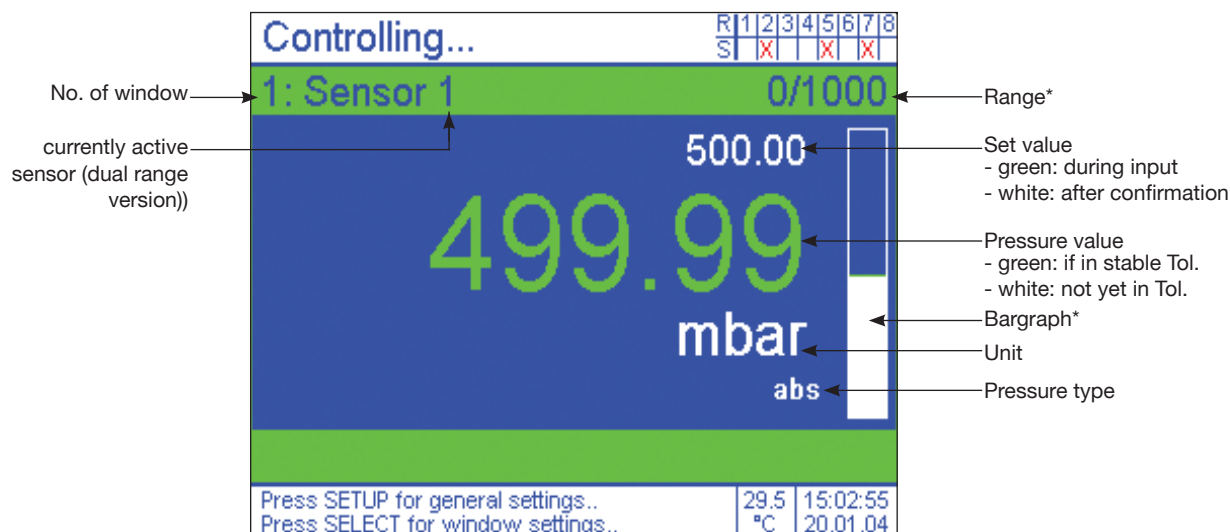

\* can be masked out

## How to set the set value:

1. Entering the set value via numerical input block  
(The given set value can be deleted via the CLEAR-key, the last set value can be called up via the BACK-key.)
2. Confirmation of the set value by pressing the ENTER-key.  
After the confirmation the CPC8000 starts to control the given set value.  
As soon as the controller reaches a pressure within the defined Stable Tolerance (Default value depending on CPC8000 version; see SETUP-menu item: Controller settings), the colour of the measured value display changes from white to green.

A stepwise change of the pressure/set value is possible via the STEP and JOG-keys

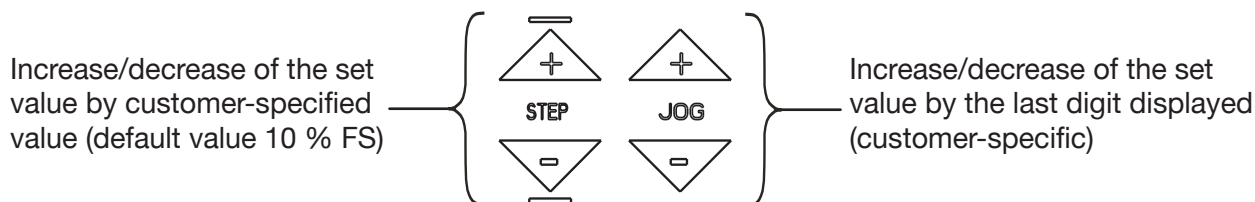

### Notice

In a multiple window representation the set value input is always assigned to the window marked in green. After confirmation the set value is automatically taken over in the other windows according to their settings. Thus it is for instance possible to input set values very fast in various units without having to carry out separate calculations.

## 6.8 Menu tree

### Measuring / controlling mode

#### SETUP-Menu

<b>Controller adaption</b>	(Adaption to current conditions / see page 40 + 41)
<b>Controller settings</b>	(General controller settings / see page 42 + 43)
<b>Sensor settings</b>	(Setting of zero point and pressure type / see page 44 + 45)
<b>Number of windows</b>	(Selection of number of windows / see page 46 + 47)
<b>General settings</b>	(General system settings / see page 48 + 49)
<b>Interfaces</b>	(Configuration of the interfaces / see page 50 + 51)
<b>User defined units</b>	(Definition of special units / see page 52 + 53)
<b>Relay settings</b>	(Assignment of relays to the windows / see page 54 + 55)
<b>Load configuration</b>	(Loading of saved settings / see page 56 + 57)
<b>Save configuration</b>	(Saving of current settings / see page 58 + 59)
<b>Info</b>	(Info about manufacturer and sensors / see page 60 + 61)
<b>Service (code)</b>	(Password protected service menu)

#### Individual Window-menu

<b>Hold</b>	(Holding measurement; activation/de-activation)	page 62 + 63
<b>Max/Min</b>	(Holding max or min value; activation/de-activation)	
<b>Zero</b>	(Setting current displayed value to zero; activation/de-act.)	
<b>Range</b>	(Pressure range; fading in/out)	page 64 + 65
<b>S-Temp</b>	(Sensor temperature, fading in/out)	
<b>Bargraf</b>	(Bar chart fading in/out)	
<b>Copy from window</b> 	(Taking over window configuration)	
<b>Sensor</b>	(Info about the precision sensor / see page 66 + 67)	
<b>Unit</b>	(Selection of the pressure unit / see page 68 + 69)	
<b>Precision</b>	(Setting of decimal places, JOG/STEP / see page 70 + 71)	
<b>Average</b>	(Building a mean value / see page 72 + 73)	
<b>Limits</b>	(Setting limit values / see page 74 + 75)	
<b>Relay values</b>	(Setting the switching points / see page 76 + 77)	
<b>Datalogging</b>	(Saving of measurements / see page 78 + 79)	
<b>Test routine</b>	(Generating of internal programs / see page 80 to 82)	

## 6.9 Calling-up the menus from out the measuring / controlling mode

### Measuring / controlling mode

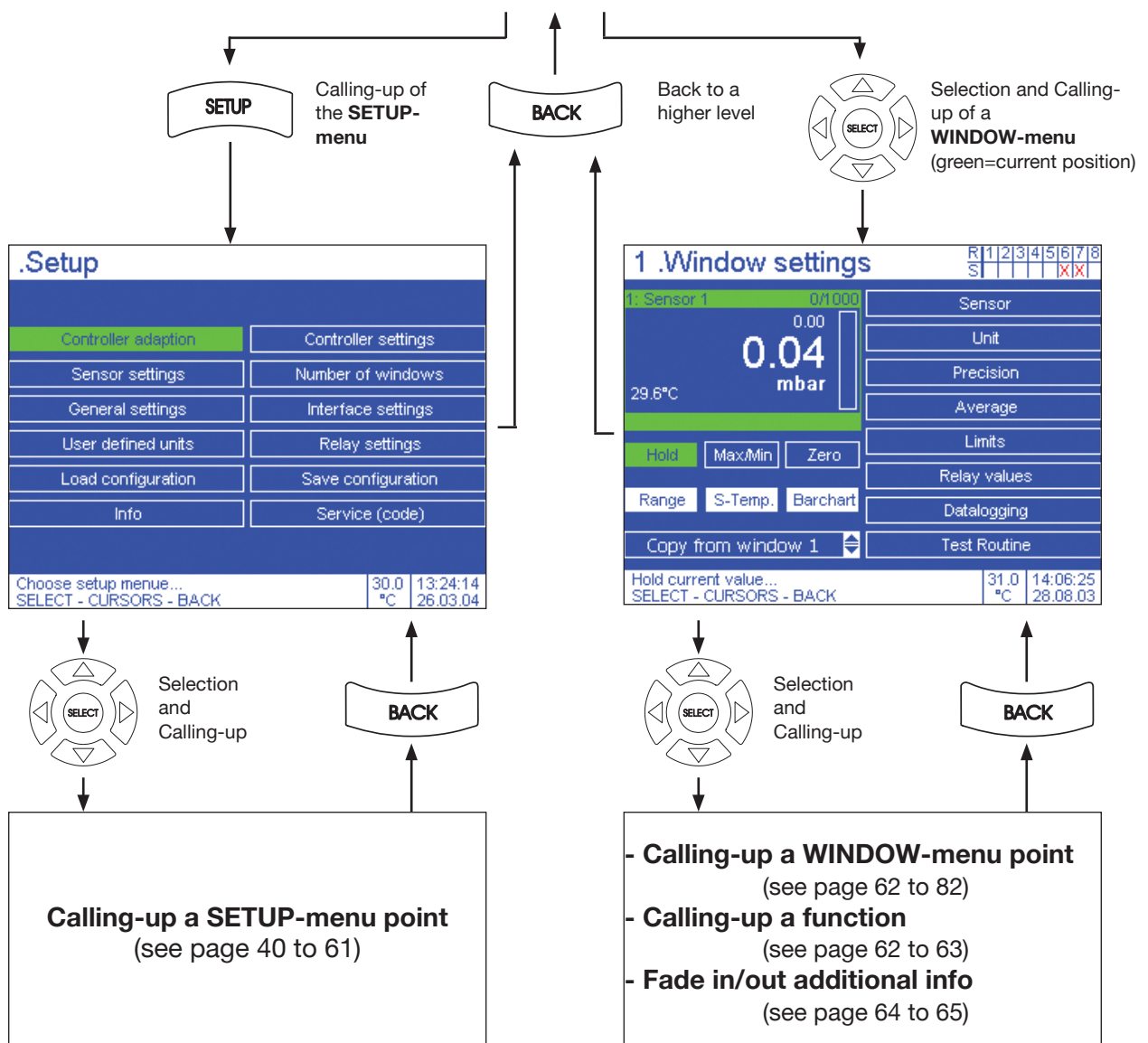
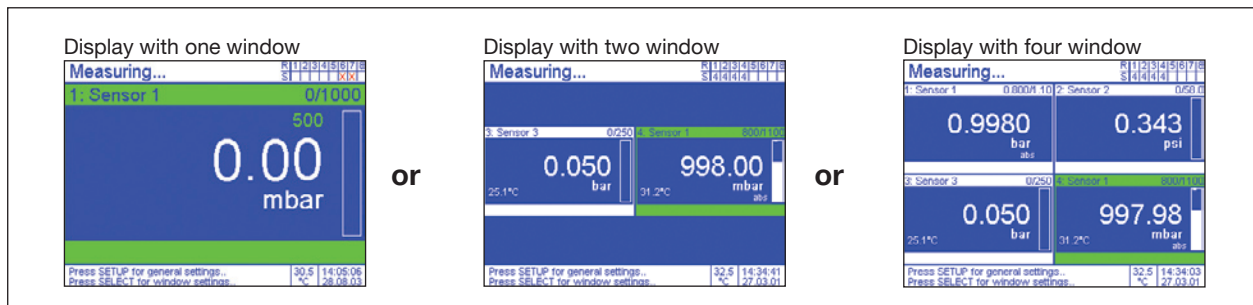

<b>green</b>	A green marking indicates the current position in the menu
<b>white</b>	A field with a white background indicates an activated menu point

## 6.9.1 SETUP-menu point: Controller adaption

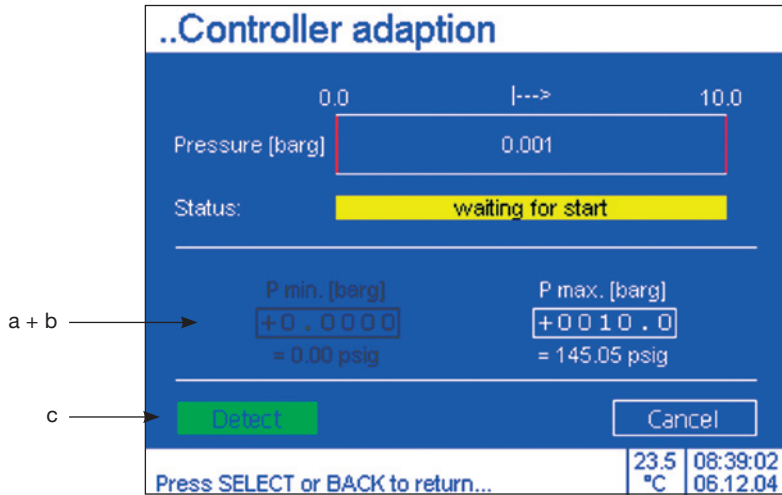

### Operation

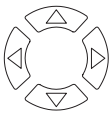

1. Selection

Input data field (a + b)		Switch field (c)	
	2. Enter field data		2. Switch on/off
	3. Run through stored list*		
	4. Move to next digit		
Repeat 3. and 4. until input data is complete			
	5. Acceptance of input		



Notice

Pressing the **BACK**-key before acceptance of the input with the **SELECT**-key takes one back to the **SETUP-menu** without any change.

\* Numbers can alternatively be keyed in directly via the numerical block

	A green marking indicates the current position in the menu
	Press once -> Calling-up of SETUP-menu; 2nd time -> MEASURE/CONTROL-mode



### 6.9.1 SETUP-menu point: Controller adaption

#### Calling-up of menu point:

see page 39

#### Function:

Automatic adjustment of controller to operating conditions.

To optimise control behaviour when instrument is started up or when operating conditions are changed considerably.

- a:** "P. min" [barg] is the limit of the min. pressure provided / controlled at the TEST port. (The value refers to a gauge pressure.)
- b:** "P. max" [barg] is the limit of the max. pressure provided / controlled at the TEST port. At the moment the lowest permissible value that can be entered for "P. max" is 1 % of the full range of the controller. (The value refers to a gauge pressure.)
- c:** Function activation and de-activation

While the control adaption function takes place, the connected test item is slowly being pressurized up to a pressure of "P. max" [barg]. (**Attention:** it has to be ensured that "P. max" [barg] does not bear any risks for the connected test item. Moreover, the pressure/vacuum at the SUPPLY LOW port must not bear any risks for the test item).



Notice

The supply pressure at the SUPPLY HIGH port should only be a little bit higher than "P. max" (see chapter: Technical Data). If the supply pressure at the SUPPLY HIGH port is actually lower than the registered "P. max" value, the system will automatically take over the true value.

It is also possible to use the controller range only partially, if for example the supply pressure is not available in the needed height (< 110 % FS). Then "P.max" has to be set approx. 10 % smaller than the available supply pressure.

With bi-directional pressure ranges, such as -1 ... +9 bar, the controller adaptation function will not run completely down to -1 bar, but (depending on the pressure range) the procedure will stop slightly before reaching this value.

## 6.9.2 SETUP-menu point: Control settings

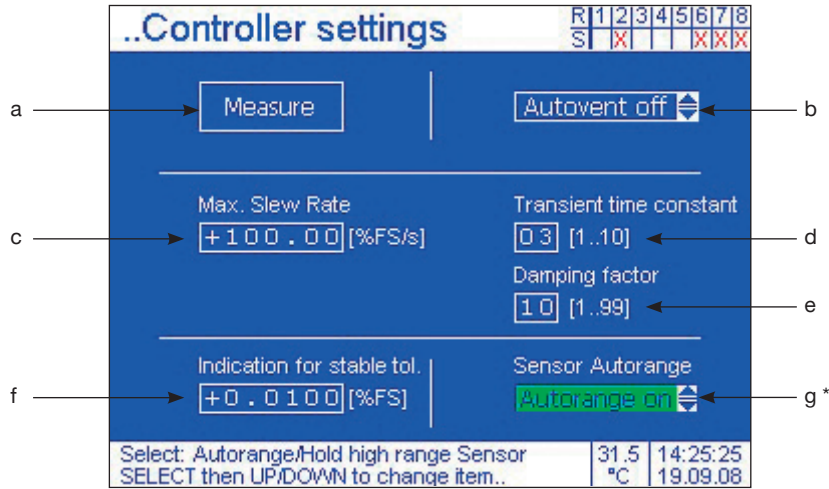

\* only valid for dual range version

## Operation

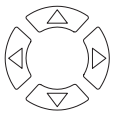

1. Selection

Switch field (a)		Scroll field (b)		Data input field (c)	
	2. Switch status		2. Enter field data		2. Enter field data
	white background = activated point		3. Run through stored list*		3. Run through stored list*
			4. Acceptance of input		4. Acceptance of input
				Repeat 3. and 4. until input data is complete	
					5. Acceptance of input



Notice

Pressing the **BACK**-key before acceptance of the input with the **SELECT**-key takes one back to the **SETUP**-menu without any change.

\* Numbers can alternatively be keyed in directly via the numerical block

	A green marking indicates the current position in the menu
	Press once -> Calling-up of SETUP-menu; 2nd time -> MEASURE/CONTROL-mode

## 6.9.2 SETUP-menu point: Control settings

### Calling-up of menu point:

see page 39

### Function:

Controller settings and activation of VENT-mode (compulsory venting of system)

- a:** Compulsory venting of system. It has the same function as the VENT key on the front panel. A connection will be made between TEST port and VENT port after activation. In this process, the accumulated pressure in the system suddenly escapes via the VENT port (pressures >10 bar, however, will be automatically regulated down to 10 bar first for safety reasons)
- b:** The setting "autovent on" automatically vents the system via the VENT port, in case zero is entered as set point and acknowledged. In case of high pressures, however, the pressure is regulated down to 10 bar first for safety reasons. Attention: If vacuum is connected at "SUPPLY LOW" port, the setting "autovent off" must have been chosen to protect the vacuum pump.
- c:** "Max. slew rate" = enter desired pressure rate of control system. 100 % FS/s = fastest control speed without overshooting of the set point. The value in % is referred to the sensor span.
- d, e:** "Transient times constant" and "Damping factor" should only be changed in case to optimise the control behaviour when the operating conditions have been changed severely but never change it more than  $\pm 1$  or  $\pm 2$  digits.
- f:** Tolerance limit in % FS will lead to a change of measuring value's colour from white to green when the current pressure value approach the set value. Admissible values: 0.0001 to 1.0000. The function is switched off when 0.0000 is entered.
- g\*:** In "autorange on" mode the controller selects automatically the optimal sensor for regulation. Execution of this function looks like it is described in section: "3.8 Operating principle of a dual-range controller". The "autorange off" mode uses always the sensor with the larger measuring range for regulation. In this mode the same accuracy cannot be obtained within the lower span compared to the smaller sensor. As a check the "autorange off" mode becomes indicated with a (!) in the main screen.

Visualising sensor  
"autorange off"

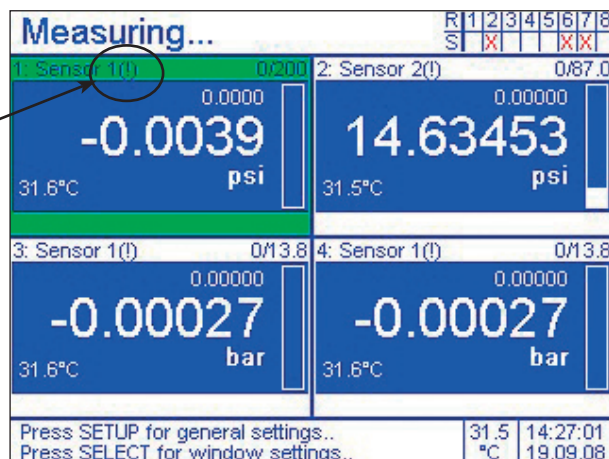

\* only valid for dual range version

## 6.9.3 SETUP-menu point: Sensor settings

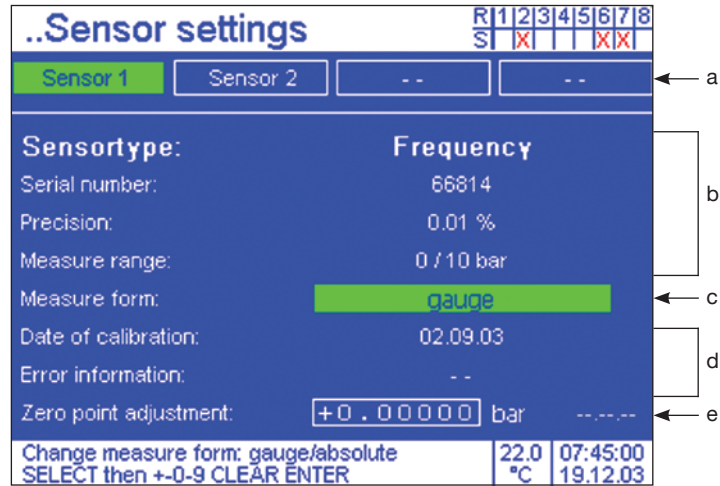

### Operation

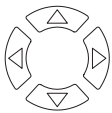

1. Selection

Switch field (c)		Data input field (e)	
	2. Switch status**		2. Enter field data
	white background = via barometr. Reference calculated pressure type  ** only possible, if a optional baromet- ric Reference is integrated.		3. Run through stored list*
			4. Move to next digit
		Repeat 3. and 4. until input data is complete	
			5. Acceptance of input



Pressing the **BACK**-key before acceptance of the input with the **SELECT**-key takes one back to the **SETUP**-menu without any change.

\* Numbers can alternatively be keyed in directly via the numerical block

	A green marking indicates the current position in the menu
	Press once -> Calling-up of SETUP-menu; 2nd time -> MEASURE/CONTROL-mode

### 6.9.3 SETUP-menu point: Sensor settings

#### Calling-up of menu point:

see page 39

#### Function:

Data and settings regarding the precision pressure sensor.

- a: Select sensor (only, if it is a dual range controller).
- b: Basic sensor data
- c: Current type of pressure; If a barometric reference sensor is integrated, it is possible to switch between absolute pressure and gauge pressure (e.g.: From a measurement range of 0 ... 6 bar abs. a -1 up to +5 bar measurement range can be generated).



Warning

**If vacuum is connected to the SUPPLY LOW port of the controller, negative pressure peaks of several -100 mbar might occur at the TEST port for a very short time, when changing from the MEASURE-mode to the CONTROL-mode.**

- d: Date of the calibration of the precision pressure sensor
- e: Permanent zero point adjustment (max. possible change: 5 % FS)

The following applies to a zero point adjustment:

- In the case of gauge pressure:  
Ensure that ambient pressure (atmospheric pressure) is applied\* at the TEST port and press the SELECT-key to activate the input function; Ensure that the value in the menu is zero and press the SELECT-key again, so that the value entered in the menu (zero) is taken over by the sensor as the new display value. If the display value is a calculated gauge pressure, the result of the calculation (generated from precision sensor - barometric reference) is set to zero.
- In the case of absolute pressure:  
Ensure that a stable value close to 0 bar absolute pressure is applied at the TEST port and precise vacuum measuring instrument connected parallel to the TEST port and press the SELECT-key again, so that the value entered in the menu is taken over by the sensor as the new display value.

\* e.g. Set the button "VENT-mode" in the "SETUP-menu point: Control settings" to VENT for the time during which the offset adjustment is carried out or use the front side button "VENT".



Notice

The setting of the zero point is stored separately for each of the two type of pressure modes.

Any change of the zero point by more than 5% FS will not be accepted, in-stead the factory setting will be reactivated.

## 6.9.4 SETUP-menu point: Number of windows

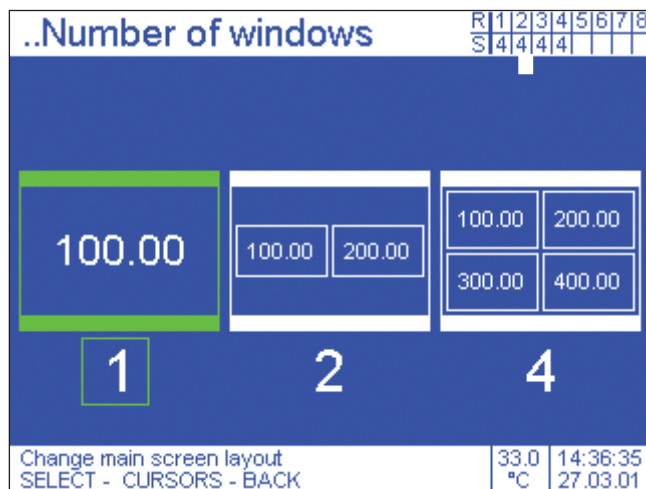

### Operation



1. Selection





2. Acceptance of choice  
(automatic return to the **SETUP-menu**)



**Notice**

Pressing the **BACK**-key before acceptance of the input with the **SELECT**-key takes one back to the **SETUP-menu** without any change.

\* Numbers can alternatively be keyed in directly via the numerical block

	A green marking indicates the current position in the menu
	Press once -> Calling-up of SETUP-menu; 2nd time -> MEASURE/CONTROL-mode

### 6.9.4 SETUP-menu point: Number of windows

#### Calling-up of menu point:

see page 39

#### Function:

opens 1,2 or 4 windows for measurement display on the screen



#### Notice

If the number of windows is reduced to 1, the window that was active before (marked green) will always be shown. When there is a change from 4 to 2 windows, either the 2 top ones or the 2 bottom ones will be shown. The line in which there was an active window (marked green) before will be taken over. When there is a change from 1 to 2 windows, the other window of the same line will also be shown.

The arrangement for 4 windows is fixed:

window 1: top left

window 2: top right

window 3: bottom left

window 4: bottom right

#### Application examples:

- displaying one measurement in different pressure units
- displaying the current measurement of a sensor in one window and applying a function (HOLD, MAX/MIN, ZERO, AVERAGE) to the measurement in another window.

## 6.9.5 SETUP-menu point: General settings

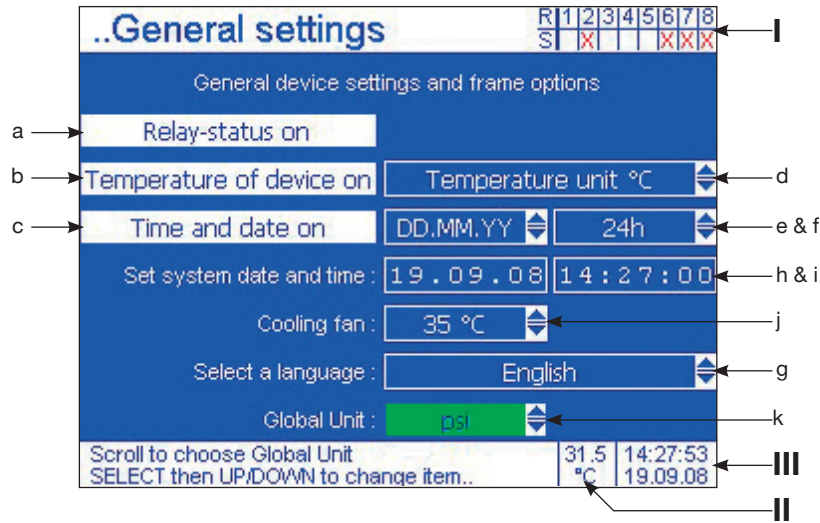

## Operation

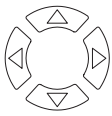

1. Selection

Switch field (a-c)		Scroll field (d-g + j + k)		Data input field (h + i)	
	2. Active/inactive		2. Enter field data		Enter field data
	white background = active point		3. Run through stored list*		3. Run through stored list*
			4. Acceptance of input		4. Move to next digit
				Repeat 3. and 4. until input data is complete	
					5. Acceptance of input



Pressing the **BACK**-key before acceptance of the input with the **SELECT**-key takes one back to the **SETUP**-menu without any change.

\* Numbers can alternatively be keyed in directly via the numerical block

	A green marking indicates the current position in the menu
	Press once -> Calling-up of SETUP-menu; 2nd time -> MEASURE/CONTROL-mode



### 6.9.5 SETUP-menu point: General settings

#### Calling-up of menu point:

see page 39

#### Function:

- a:** Fading in/out of Relay status list (see: **I** and "Relay setting" Page 54 + 55)
- b:** Fading in/out internal temperature of instrument (see: **II**)
- c:** Fading in/out of real time and date (see: **III**)
- d:** Selection of the unit of the internal temperature (°C / °F)
- e:** Configuration of the date (day:month:year / month:day:year)
- f:** Configuration of the real time (24 h. / 12 h.)
- h + i:** Setting of the date and real time
- g:** Selection of the language (German/English)
- j:** Set value in degrees Celsius at which the built-in fan (at the back of the system) will be automatically switched on. It will be automatically switched off again, as soon as the inside temperature of the system drops to 2 °C below the respective set value.
- k:** Selection of the Global Unit. Global Unit is the unit, in which all pressure values are conveyed over the interface to the computer.

## 6.9.6 SETUP-menu point: Interface

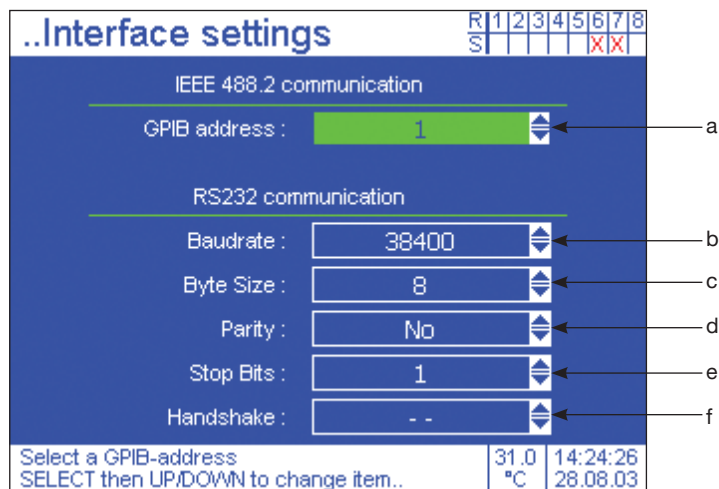

### Operation

	1. Selection
	2. Enter field data
	3. Run through stored list*
	4. Acceptance of input

	A green marking indicates the current position in the menu
	Press once -> Calling-up of SETUP-menu; 2nd time -> MEASURE/CONTROL-mode

### 6.9.6 SETUP-menu point: Interface

#### Calling-up of menu point:

see page 39

#### Function:

Configuration of interfaces

- a:** Selection of the GIPB address of the **IEEE-488.2** interface (0 - 30)
- b:** Selection of the Baud rate of the **RS-232** interface (110/300/600/1200/2400/4800/9600/14400/19200/38400/56000/57600/115200/128000/256000)
- c:** Selection of the Byte size (4/5/6/7/8)
- d:** Selection of the parity of the **RS-232** interface (even, odd, no, space, mark)
- e:** Selection of the stop bits of the **RS-232** interface (1/2/1.5)
- f:** Selection of the handshake of the **RS-232** interface (RTS/CTS or no handshake)

#### Application examples:

- Full automatic calibration of pressure instruments via calibration software of WIKA
- LabVIEW® link-up



Notice

See enclosure: Interface communication



## 6.9.7 SETUP-menu point: User defined units

### Calling-up of menu point:

see page 39

### Function:

Definition of special customer-specific pressure units

**a:** Name of unit

**b:** Amount of the factor (referred to unit: bar)

**c:** Exponents of the factor (referred to unit: bar)

### Example 1:

Wanted User defined unit **kilo Pascal**: with  $1 \text{ kPa} = 1 \times 10^{-2} \text{ bar}$

Name (**a**) = kPa

Amount (**b**) = 1

Exponent (**c**) = -2

=> if e. g.: the current pressure value is equal to 1 bar so the display will show 100 kPa

### Example 2:

Wanted User defined unit **Mega Pascal**: with  $1 \text{ MPa} = 1 \times 10^1 \text{ bar}$

Name (**a**) = MPa

Amount (**b**) = 1

Exponent (**c**) = 1

=> if e. g.: the current pressure value is equal to 1 bar so the display will show 0.1 MPa

### Example 3:

Wanted User defined unit **PSI**: with  $1 \text{ psi} = 6,8948 \times 10^{-2} \text{ bar}$

Name (**a**) = psi

Amount (**b**) = 6,8948

Exponent (**c**) Exponent (**c**) = -2

=> if e. g.: the current pressure value is equal to 1 bar so the display will show 14.50 psi



Notice

The user-defined units generated can be selected in the Window-menu / point "Units" (see pages 68 + 69).

## 6.9.8 SETUP-menu point: Relay settings

### Operation

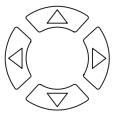

1. Selection

Input data field (a)		Scroll field (b)		Switch field (c)	
	2. Enter field data		2. Enter field data		2. Active/inactive
	3. Run through stored list*		3. Run through stored list*		white background = activated point
	4. Move to next digit		4. Acceptance of input		
Repeat 3. and 4. until input data is complete					
	5. Acceptance of input				



Pressing the **BACK**-key before acceptance of the input with the **SELECT**-key takes one back to the **SETUP**-menu without any change.

\* Numbers can alternatively be keyed in directly via the numerical block

	A green marking indicates the current position in the menu
	Press once -> Calling-up of SETUP-menu; 2nd time -> MEASURE/CONTROL-mode

## 6.9.8 SETUP-menu point: Relay settings

### Calling-up of menu point:

see page 39

### Function:

Assigning 3 of the 8 integrated relays to any of the windows available.

**a:** Name of the relay (optional)

**b:** Assigning the relay to any window

**c:** Operating the relay manually (only possible if the relay is not assigned to a window)



Notice

The relays no. 4 up to no. 8 are used by the controller for internal task and can not be used by the user (PIN-configurations of the relays on page 25).

The switching points of the relays are set in the corresponding Window-menu / point "Relay values" (see pages 76 + 77).

The status of a relay is shown in the relay status list faded in (top right of the screen).

The number under the relay number is the window number to which the relay is assigned.

If the relay is operated, the number will be replaced by a red X.

When there is no sign under a relay number it is not assigned to a window and it can be switched manually via this menu point.

### Application examples:

Pressure-dependent switching of valves, e.g. as overpressure protection of uncritical processes.

## 6.9.9 SETUP-menu point: Load configuration

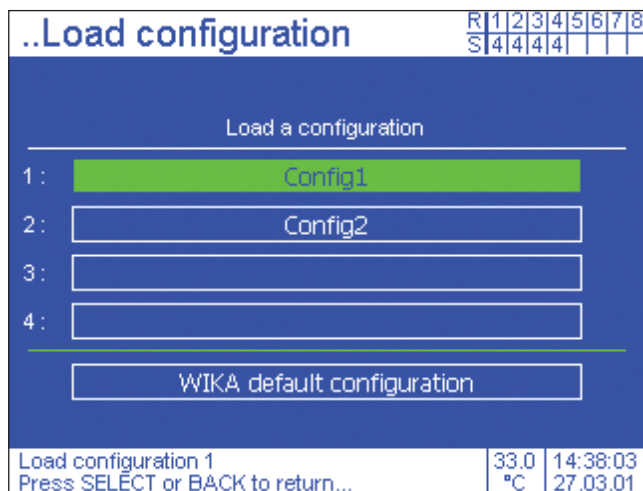

### Operation



1. Selection



2. Acceptance of choice (automatic return to the **SETUP-menu**)



**Notice**

Pressing the **BACK**-key before acceptance of the input with the **SELECT**-key takes one back to the **SETUP-menu** without any change.

**green**

A green marking indicates the current position in the menu

**BACK**

Press once -> Calling-up of **SETUP-menu**; 2nd time -> **MEASURE/CONTROL-mode**



## 6.9.9 SETUP-menu point: Load configuration

### Calling-up of menu point:

see page 39

### Function:

Loading of saved configuration (see also: SETUP-menu point: Saving of configuration)



Notice

Current changes are always saved in the background of the system control as a separate unnamed working configuration, which is re-established directly when it is switched off or on.

## 6.9.10 SETUP-menu point: Save configuration

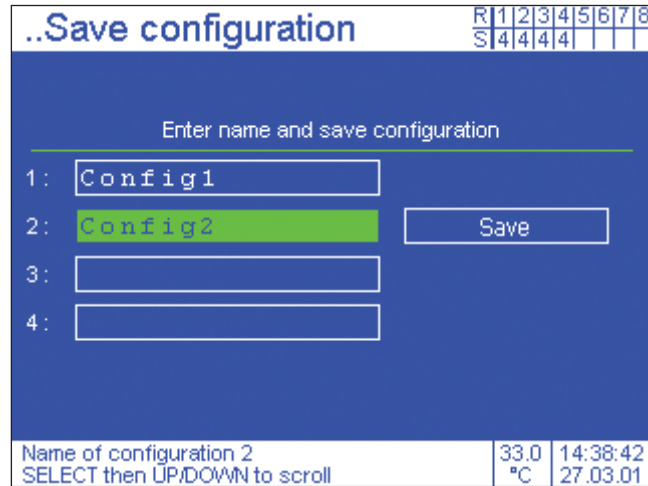

### Operation

	1. Selection		
	2. Enter field data		6. Move to field "Save"
	3. Run through stored list*		7. Save configuration
	4. Move to the next digit		
Repeat 3. and 4. until input data is complete			
	5. Acceptance of input		



#### Notice

Pressing the **BACK**-key before acceptance of the input with the **SELECT**-key takes one back to the **SETUP**-menu without any change.

\* Numbers can alternatively be keyed in directly via the numerical block

	A green marking indicates the current position in the menu
	Press once -> Calling-up of SETUP-menu; 2nd time -> MEASURE/CONTROL-mode

## 6.9.10 SETUP-menu point: Save configuration

### Calling-up of menu point:

see page 39

### Function:

Saving of the momentary configuration



Notice

The name can consist of any sequence of letters and numbers.

### Application examples:

Saving of frequently used settings of the user surface and calling them up as required with the help of the "**SETUP-menu point: Loading of configuration**"

## 6.9.11 SETUP-menu point: Info

..Info		R	1	2	3	4	5	6	7	8
		S	X				X	X		
		Alexander Wiegand GmbH & Co. KG D-63911 Klingenberg / Germany <a href="http://www.wika.de">http://www.wika.de</a>								
CPC8000 #Z80020C										
Firmware: 1.9.1.0 PRE1										
Integrated sensor(s)		Calibrated								
1:	0.01% 0.0/10.0 bar	02.09.03								
2:										
3:										
4:										
Barometric reference		01.10.03								
Press BACK to return...		22.0	07:44:23							
		°C	19.12.03							

## Operation

Can not be changed by the client!

### 6.9.11 SETUP-menu point: Info

**Calling-up of menu point:**

see page 39

**Function:**

Information regarding the serial number, firmware and list of the integrated sensor mechanism with date of the last calibration.

## 6.9.12 WINDOW-menu direct action keys: Hold, Max/Min, Zero

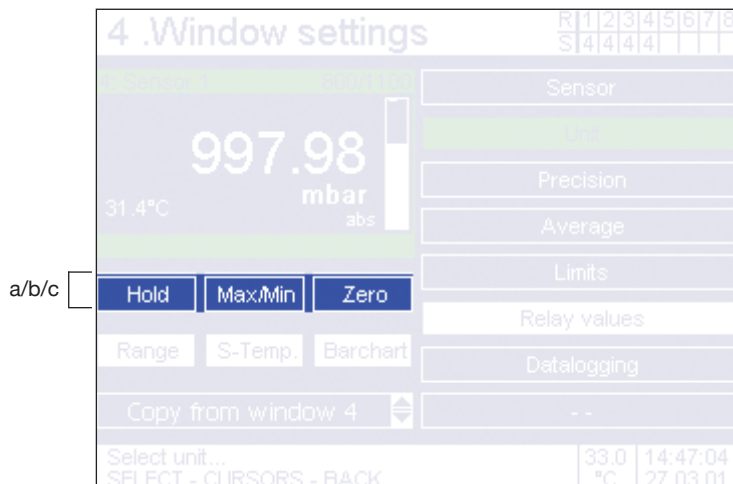

### Operation

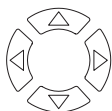

1. Selection



2. Active/inactive



**Notice**

white background = activated; resp. if a field is marked green, the characters are white instead of blue

For a permanent Zero point correction, please see: "SETUP-menu: Sensor settings"

**green**

A green marking indicates the current position in the menu



Press once -> Calling-up of SETUP-menu; 2nd time -> MEASURE/CONTROL-mode

### 6.9.12 WINDOW-menu direct action keys: Hold, Max/Min, Zero

#### Calling-up of menu point:

see page 39

#### a: **Function:** hold the current pressure value

Press **SELECT** once = measurement shown is no longer updated

##### **Activation evident through out:**

- In the lower beam of the window the word "Hold" appears

##### **Effect:**

- no effect on a shown bar chart (see pages 64 + 65)



Notice

If the direction keys are used for changing to another field, the function is deactivated automatically.

#### Application examples:

Recording a measurement safely at a particular time.

#### b: **Function:** displaying maximum or minimum measurement

Press **SELECT** once = measurement shown is only updated if the value measured is bigger than the one displayed at the moment.

##### **Activation evident through out:**

- In the lower beam of the window the word "MAX" appears

##### **Effect:**

- A bar shown bar chart (see pages 64 + 65) is only updated together with the measurement displayed

Press **SELECT** a second time = measurement shown is updated only if the value measured is smaller than the one displayed at the moment.

##### **Activation evident through out:**

- In the lower beam of the window the word "MIN" appears

##### **Effect:**

- A shown bar chart (see pages 64 + 65) is only updated together with the measurement displayed

Press **SELECT** a third time = measurement shown is updated again.

#### Application examples:

Recording an extreme value during a measuring period .



Notice

The measurement rate is max. 8 values per second (depending on the type of sensor).

#### c: **Function:** setting the zero point

Press **SELECT** once = setting measurement currently shown to zero

##### **Activation evident through out:**

- In the lower beam of the window the word "Zero" appears

##### **Effect:**

- No effect on a shown bar chart (see pages 64 + 65)

Press **SELECT** a second time = function will be deactivated

#### Application examples:

- Setting the zero point of relative pressure sensors
- Measuring relative pressure with an absolute pressure sensor



Notice

Future changes of air pressure are not taken into consideration.

## 6.9.13 WINDOW-menu direct action keys: Range, S-Temp, Barchart, Copy from window X

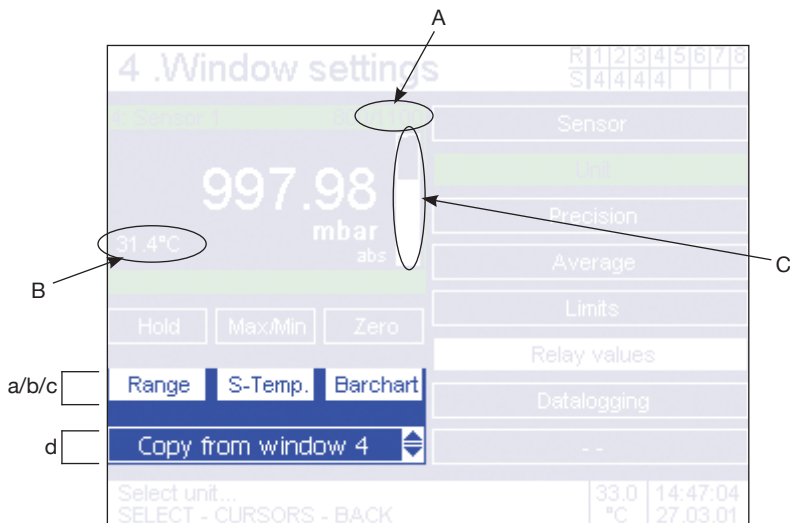

### Operation



1. Selection



2. Active/inactive



Notice

white background = activated  
or respective appears a button green because it is selected then are the figures in blue to indicate the activation.

<b>green</b>	A green marking indicates the current position in the menu
	Press once -> Calling-up of SETUP-menu; 2nd time -> MEASURE/CONTROL-mode



## 6.9.13 WINDOW-menu direct action keys: Range, S-Temp, Barchart, Copy from window X

### Calling-up of menu point:

see page 39

### Function:

**a: (Range):** Fading in/out the pressure range of the sensor

Press **SELECT** once = the measuring range of the sensor is faded in on the right of the top green beam of the window (see: **A**).

#### Activation evident through out:

■ The field "range" is shown with a white background

Press **SELECT** for the second time = the measuring range of the sensor is faded out again

**b: (S-Temp.):** Fading in/out the additional temperature signal of the pressure sensor

Press **SELECT** once = the temperature signal is faded in on the left at the bottom of the window (see **B**).

#### Activation evident through out:

■ The field "S-Temp." is shown with a white background

Press **SELECT** for the second time = the temperature is faded out again

**c: (Barchart):** Fading in/out bar chart

Press **SELECT** once = Fade in a barchart in the window on the right (see: **C**)

#### Activation evident through out:

■ The field "barchart" is shown with a white background

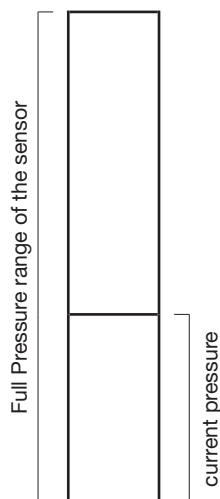

**d: (Copy from window X):** Take over configuration of another window

## 6.9.14 WINDOW-menu point: Sensor

1..Sensor			R	1	2	3	4	5	6	7	8
			S	X				X	X		
Sensor 1: 0.01% 0.0/10.0 bar											
--											
--											
--											
--				--				--			
--				--				--			
--				--				--			
--				--				--			
Choose sensor for this window...			27.5			12:33:25					
Press SELECT or BACK to return...			°C			19.12.03					

## Operation

Can not be changed by the client!

<b>green</b>	A green marking indicates the current position in the menu
	Press once -> Calling-up of SETUP-menu; 2nd time -> MEASURE/CONTROL-mode

## 6.9.14 WINDOW-menu point: Sensor

**Calling-up of menu point:**  
see page 39

**Function:**  
Information about the integrated high-precision pressure sensor



**Notice**

An optional barometric reference sensor is not mentioned here.  
The graphic complexity of this menu point results from the fact that the menu structure of the multi-sensor precision pressure measuring system CPG8000 is used.

## 6.9.15 WINDOW-menu point: Unit

1..Unit			R	1	2	3	4	5	6	7	8
			S	X				X	X	X	
a	bar	mbar	Pa								
	psi	atm	kp/cm2								
	lbf/ft2	kPa	cmH2O(4°C)								
	inH2O(4°C)	inH2O(20°C)	inH2O(60°F)								
	ftH2O(4°C)	mmHg(0°C)	cmHg(0°C)								
	inHg(0°C)	inHg(60°F)	% FS								
b	--	--	--								
c	Global Unit										
d	no time base	1/s	1/min	1/h							
Optional select time base Press SELECT or BACK to return...			31.5	14:28:48							
			°C	19.09.08							

## Operation

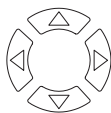

1. Selection



2. Acceptance of choice



### Notice

- a/b: field with background = momentary active unit
- d: field with background = with or without a time base
- Pressing the BACK-key before acceptance of the choice with the SELECT-key takes one back to the WINDOW-Menu without any change.

**green**

A green marking indicates the current position in the menu

**BACK**

Press once -> Calling-up of SETUP-menu; 2nd time -> MEASURE/CONTROL-mode

### 6.9.15 WINDOW-menu point: Unit

#### Calling-up of menu point:

see page 39

#### Function:

Selection of a pressure unit.

#### a: 17 pre-determined units

If the customer changed the Global Unit this has no effect on the displayed unit in the window.

#### b: 3 user-definable units (see pages 52 + 53)

#### c: Is the Global Unit selected and the customer changes it, the unit in the main screen changes too.

#### d: relate optional: pressure to a time base (second, minute or hour) to display change of pressure per time.



Warning

**When choosing a time base the value displayed in the window does not give any statement about the static stress of the sensor. There is a danger that the sensor is pressurised with a pressure which is above the maximum permissible pressure range.**

**The normal pressure measurement of the sensor should therefore be displayed simultaneously in a second window (2 or 4 windows representation).**

#### Application example:

#### d: Display rate of pressure change for leakage tests



Notice

a/b: If the measuring range cannot be reasonably represented by the unit desired, a selective confirmation is not possible.

d: The choice of a time base does not have any effect on a displayed barchart (see pages 64 + 65)

- The bigger the time base is chosen, the stronger is the effect of short-time changes on the value displayed (=> very high values).

Example:

Pressure unit: bar

Pressure (T1) = 1 bar

Pressure (T2) = 2 bar

T2-T1 = 0,2 sec

chosen time base: 1/h

displayed value:  $\text{Pressure (T2) - Pressure (T1)} \times \frac{3600}{0,2 \text{ sec}} = \underline{18000 \text{ bar/h}}$

The effect of the pressure change on the value displayed can be minimised with the Window-menu point: "Average" (see pages 72 + 73).

In the appendix: CONVERSION TABLE are specific Information concerning the used and further units.

## 6.9.16 WINDOW-menu point: Precision

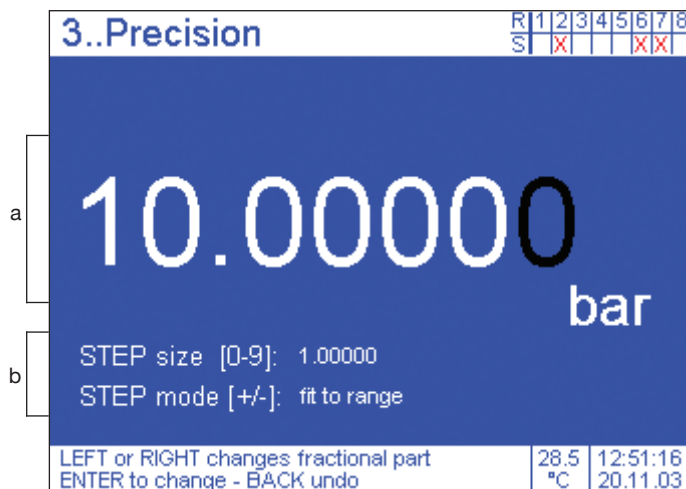

### Operation

#### a) Configuration of the decimal places and thus of the JOG-key



1. Select number of decimal places (colour change from white to green during the input process)



2. Confirmation (colour change from green to white)

#### b) Configuration of the STEP-key (default value: 10 % FS)

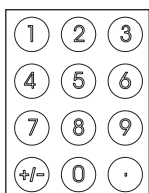

1. Input of the desired STEP size in % FS  
(colour change from white to green during the input process)



2. Selection: adapt STEP function to range limits or not



3. Confirmation (colour change from green to white)



Notice

- Digits marked in black will be not displayed in the MEASURE/CONTROL-mode
- Pressing the **BACK**-key before a confirmation with the **ENTER**-key will terminate the input process without any change.

**green**

A green marking indicates the current position in the menu

**BACK**

Press once -> Calling-up of SETUP-menu; 2nd time -> MEASURE/CONTROL-mode

### 6.9.16 WINDOW-menu point: Precision

#### Calling-up of menu point:

see page 39

#### Function:

- a) ■ Reducing or increasing the number of digits shown after the decimal point (of the current pressure value on the screen and the above displayed set value)
- Configuration of the JOG-key (JOG size), since the JOG-key influences the last displayed digit of the set value.

The measurement can be displayed with a maximum of 7 digits. The digits shown before the decimal point in the menu window correspond to the number of digits before the decimal point of the maximal measuring range of the sensor. Only digits after the decimal point can be faded out. The value displayed is rounded down or up when the highest digit faded out is smaller or bigger than 5.

b) Configuration of the STEP-key (STEP size)

The STEP size can be set in % FS by using the numerical input block (default value: 10 % FS). The setting 0.00000 is not permissible as an input value.

When pushing the CLEAR-key, the STEP size will be adjusted to the size of the JOG size.

With the help of the sign key it is possible to force an always exact hitting of the upper limit resp. the lower limit of the range.

If the setting "STEP mode [+/-]: fit to range" is selected, the last step of the STEP-key (if necessary) will be adapted to a size, so that the upper limit resp. the lower limit of the range will be exactly hit .



Notice

- The settings are always window related.
- When changing to another unit, the number of digits after the decimal point may change and the number of digits before the decimal point may go up. Normally it is tried not to change the number of displayed digits.

#### Example:

10 bar -> 145 psi

1450.3 psi -> 100.00 bar

## 6.9.17 WINDOW-menu point: Average

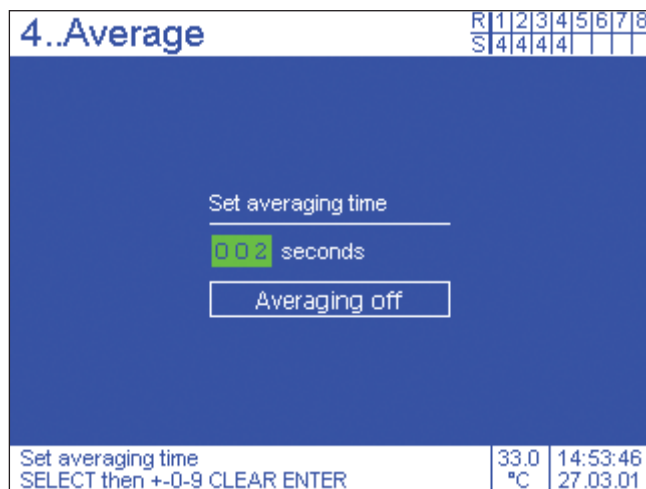

### Operation

	1. Select field "Seconds"
	2. Input activation
	3. Run through stored list
	4. Move to next digit if required
5. Repeat 3. and 4. until input data is complete	
	6. Acceptance of input
	7. Move to field "Average on" or "off"
	8 Switch between active and inactive
	<ul style="list-style-type: none"> <li>■ White background = activated</li> <li>■ Numbers can alternatively be keyed in directly via the numerical block</li> <li>■ Pressing the BACK-key before acceptance of choice with the SELECT-key takes on back to the WINDOW-menu without any change.</li> </ul>

Notice

	A green marking indicates the current position in the menu
	Press once -> Calling-up of SETUP-menu; 2nd time -> MEASURE/CONTROL-mode



### 6.9.17 WINDOW-menu point: Average

#### Calling-up of menu point:

see page 39

#### Function:

Calculates the averages related time base in seconds



Notice

The bigger the time of the averaging chosen is, the less current pressure changes will become noticeable.



Warning

**When choosing an averaging, the value displayed in the window does not give an exact statement about the static stress of the sensor. There is a danger that the sensor is pressurised for a short time with a pressure which is above the maximum permissible pressure. The normal pressure measurement of the sensor should therefore be displayed simultaneously in a second window (2 or 4 windows representation).**

#### Example:

Measuring rate: 5 values per sec.

Averaging time: 1 sec

Pressure (T-4): 1 bar

Pressure (T-3): 1 bar

Pressure (T-2): 1 bar

Pressure (T-1): 2 bar

Pressure (T0): 10 bar <- current pressure at time T0

Averaged value displayed at time T0: 3 bar

The value displayed is re-calculated continuously (flexible average value formation) through out that the pressure (T0 + 1) is included into the averaging and the oldest value is no longer taken into consideration.



Notice

The average function only serves as filter to stabilize the pressure value displayed on the screen and has no affect to the internal calculation/handling or the transferred data via interface.

## 6.9.18 WINDOW-menu point: Limits

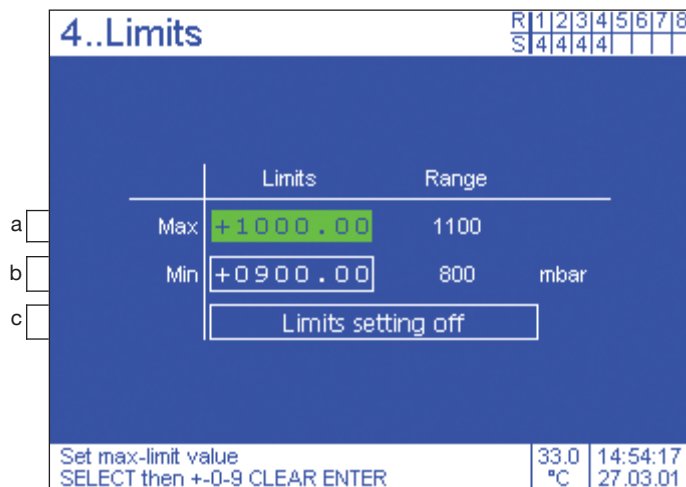

### Operation



1. Selection of "Min" or "Max" input field



2. Input activation



3. Run through stored list



4. Move to next digit if required

5. Repeat 3. and 4. until input data is complete



6. Input acceptance

7. Repeat point 1 to 6. until second value is feed in.



8. Move to field "Limits on" or "off"



9. Switch between active and inactive



Notice

- **c**: White background = activated
- **a/b**: Numbers can alternatively be keyed in directly via the numerical block

green

A green marking indicates the current position in the menu

BACK

Press once -> Calling-up of SETUP-menu; 2nd time -> MEASURE/CONTROL-mode

### 6.9.18 WINDOW-menu point: Limits

**Calling-up of menu point:**

see page 39

**Function:**

Setting Min. and Max. limit value.

**a:** Setting maximum limit value (max. value = value faded in on right)

**b:** Setting minimum limit value (min. value = value faded in on right)

**c:** Activate or deactivate function

**Effect:**

If the current measurement is outside the limit values, it will be displayed in red.

If the bargraph is displayed (see pages 64 + 65), the limit values are indicated as red lines.

## 6.9.19 WINDOW-menu point: Relay values

Relais Status

Relay No.

Window No. or if relay activated: X

	Relais	Status	Relay No.
	R	S	1 2 3 4 5 6 7 8
		X	
		X	
		X	

	Activate higher than:	Deactivate lower than:	
1:	R1 +0900.00	+0850.00	mbar
2:	R2 +1000.00	+0990.00	mbar
3:	R3 <b>+1100.00</b>	+1100.00	mbar

First define relays for this window

29.5 °C 14:59:01  
20.01.04

a b

### Operation



1. Selection



2. Input activation



3. Run through stored list



4. Move to next digit if required

5. Repeat 3. and 4. until input data is complete



6. Input acceptance

7. Repeat point 1. to 6. until input is complete.



Notice

Numbers can alternatively be keyed in directly via the numerical block

**green**

A green marking indicates the current position in the menu

BACK

Press once -> Calling-up of SETUP-menu; 2nd time -> MEASURE/CONTROL-mode

## 6.9.19 WINDOW-menu point: Relay value

**Calling-up of menu point:**  
see page 39

**Function:**

Configuration of the Relays assigned to the window (see Page 54 + 55).

**a:** Activation pressure (Switch-on point)

**b:** De-activation pressure (Switch-off point)

Depending on the use of the closer or the opener of the change-over contact, electrical loads (max. 30 V DC/1 A) can be switched on or off with the relay. A difference between the activation pressure and the deactivation pressure (switching hysteresis) prevents bouncing of the switch with minor pressure fluctuations.

If the bargraph is displayed, the switching points will appear there as tiny marker points.

e.g.:

	Activate if greater than:	Deactivated if smaller than:
1:	+ 0 1 0 . 5 0 0	+ 0 0 9 . 5 0 0
2:	+ 0 1 0 . 5 0 0	+ 0 0 9 . 5 0 0

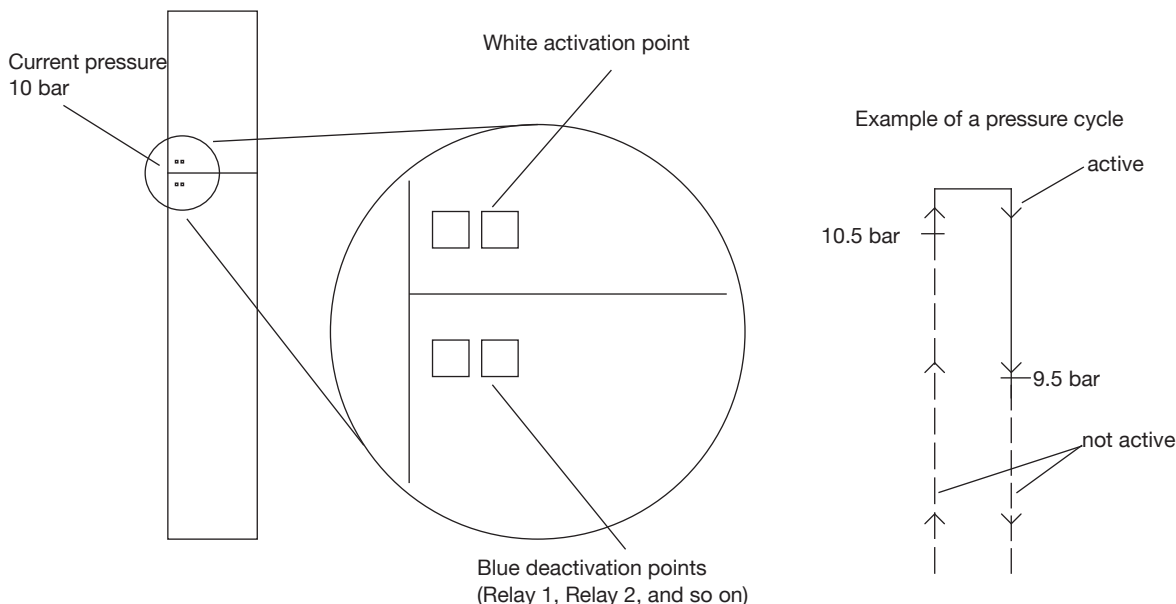

The deactivation points, because they are represented in blue, will only become visible when the pressure is bigger than the deactivation value. The activation points, because they are represented in white, are no longer visible when the pressure is higher than the activation value.

## 6.9.20 WINDOW-menu point: Datalogging

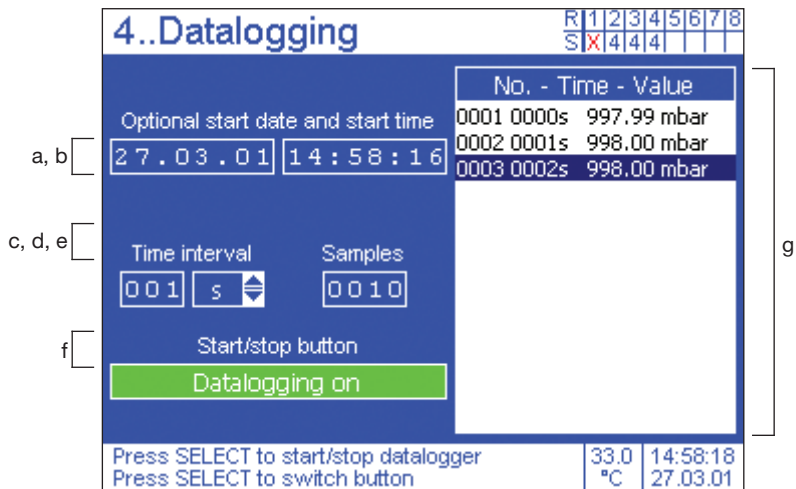

### Operation



1. Selection

Data input field (a, b, c, e)		Scroll field (d)		Switch field (f)		Data stored field (g)	
	2. Enter field data		2. Enter field data		2. Active/ inactive		If recording has been completed, it is possible to enter data listing
	3. Run through stored list*		3. Run through stored list*		white background = activated		Run through stored data*
	4. Move to next digit		4. Input acceptance				
Repeat 3. and 4. until input data is complete							
	5. Input acceptance						

\* Numbers can alternatively be keyed in directly via the numerical block

	A green marking indicates the current position in the menu
	Press once -> Calling-up of SETUP-menu; 2nd time -> MEASURE/CONTROL-mode

## 6.9.20 WINDOW-menu point: Datalogging

### Calling-up of menu point:

see page 39

### Function:

Recording of measurements.

- a, b:** Entering optional starting date and time
- c, d:** Entering desired time interval (1 - 999) and selecting time unit sec/min/h
- e:** Entering number of values which are to be recorded (1 - 1999)
- f:** Activation of data recording (If a starting date/time which lies in the future was entered previously, the recording will not start until this selected time)
- g:** Data stored field with the data recorded



Notice

Every time the data saving is newly activated or the system is switched off the recorded values will be lost.

Dual range version do not support this function.



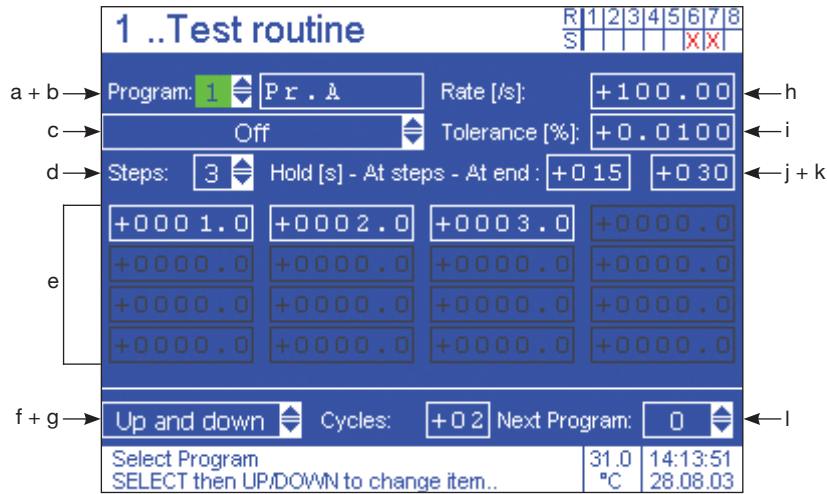

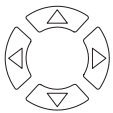

## 6.9.21 WINDOW-menu point: Test routine





### Operation



1. Selection

Data input field (b, e, g, h, i, j, k)		Scroll field (a, c, d, f, l)	
	2. Enter field data		2. Enter field data
	3. Run through stored list*		3. Run through stored list*
	4. Move to next digit		4. Acceptance of input
Repeat 3. and 4. until input data is complete			
	5. Acceptance of input		

\* Numbers can alternatively be keyed in directly via the numerical block

	A green marking indicates the current position in the menu
	Press once -> Calling-up of SETUP-menu; 2nd time -> MEASURE/CONTROL-mode



### 6.9.21 WINDOW-menu point: Test routine

#### Calling-up of menu point:

see page 39 (before calling-up the menu point the CPC8000 has to be in the MEASURE-mode)

#### Function:

Programming of internal test programs.

**a, b:** Program number (1 - 5) with an optional program name

**c:** Mode of the program: (automatic, manual, off)

- Automatic: Program starts and runs automatically when the CONTROL-key is pressed in the MEASURE/CONTROL-mode.

- Manual: The individual program steps/pressure steps are called up one after the other by means of the STEP UP/DOWN-keys. Hold times are not activated during this process. The program is started by means of pressing the CONTROL-key in the MEASURE/CONTROL-mode.

- Off: Program is deactivated.

**d:** Enter the number of pressure steps desired (1 - 16).

**e:** Specify the pressure value of the individual pressure steps.

**f:** Define program structure for automatic mode (only upwards / up and down)

- only upwards: pressure steps are only executed forwards from beginning to end.

- up and down: pressure steps are executed from beginning to end and then backwards.

**g:** Number of cycles (1 - 99)

**h:** Control rate (0 - 100)

- automatic takeover of the SETUP setting

- 100: fastest setting without overshooting

- "other": percentage of the fastest setting.

**i:** Indication of tolerance in % FS (0.01 - 1). As soon as the pressure is controlled within the tolerance, the colour of the pressure value changes from white to green. This will be also the starting point for the hold time (see: "j") of the pressure step.

**j:** Hold time of the pressure step in seconds (1 - 999). When the tolerance (see: "i" ) of the pressure step is reached the hold time will start to count. If the hold time is over the CPC8000 will start to control the next pressure step.

**k:** Hold time at the end of a cycle defined under "e".

**l:** Program number of the next/following program (0 - 5)

- 0: no successor program

- The same number used in "a": Infinite loop; can be terminated by pressing the MEASURE-key.

- "other": Successor program which will be automatically started next.



Notice

The pressure steps are input in the window-specific unit and are subsequently displayed in the window-specific unit.

Example: (see next page)

# High-Precision Pressure Controller CPC8000

## Example:

see menu settings of program: No. 1, Pr. A (on previous page)

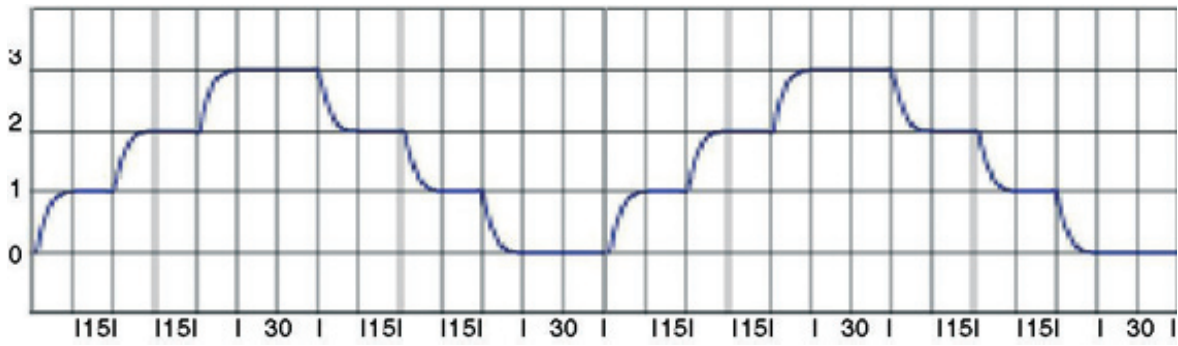

pressure per time (with holding times)

## FOR YOUR NOTES

**FOR YOUR NOTES**

## 7. Trouble-shooting measures



Warning

If faults cannot be repaired, the system must be put out of operation immediately and protected against unintentional re-starting. Further this information is to be given to a superior and to authorize service personnel.

Repairs must only be carried out by the manufacturer. Interventions and changes on the appliance are not allowed.

Work on electrical or pneumatic/hydraulic equipment must only be carried out by qualified and authorised technical staff, observing the corresponding safety regulations.

In case of faults caused by defects of the electrical or pneumatic/hydraulic equipment the operators must inform their superiors immediately and call in the qualified and authorised technical staff for maintenance.

7.1 Table: Fault description and measures

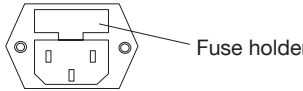
Type of fault	Measures
I. After the system is switched on and after 10 seconds still no measurement(s) appear(s), but the entire area of the screen is white or dark.	Switch off system and switch on again after 5 seconds.
II. The screen is dark and the measures for faults of type I are without effect.	Check that the mains cable is connected properly and have authorised technical staff check that the supply voltage is correct.
III. The screen is dark and the measures for faults of type II are without effect.	<p>First pull out the mains cable from the mains socket and then from the power supply input socket of the system. Then pull out the fuse holder and check the fuses.</p> <div style="text-align: center;">  <p>Fuse holder</p> <p>Power supply input socket</p> </div>

Type of fault	Measures
IV. Malfunction during operation	Switch off system and switch on again after 5 seconds.
V. Instable control	Leak-test the pipework and check the settings in the SETUP-menu point "Control settings" for correctness.
VI. Intensified release of pressure medium at the SUPPLY LOW port during pressure controlling.	Switch the system off and after approx. 5 seconds on again. (Controller re-initialises itself)
VII. The set value is not reached.	Check whether the value of the supply pressure at the SUPPLY HIGH port is the value required (see chapter: Technical Data) and leak-test the pipework. Also check whether the setting of "P. max" in the SETUP-menu: Controller Adaption is correct.



**If the fuses of the power supply input socket have to be replaced, only 2 Ampere fuses type T2L250V may be used.**

**If you require further help please contact the WIKA department of Calibration Technology under:**

Tel. +49 (0) 93 72/132-9986  
 Fax. +49 (0) 93 72/132-217  
 E-mail: [testequip@wika.de](mailto:testequip@wika.de)

### 8. Re-calibrating and servicing

We recommend having the system re-calibrated by the manufacturer at regular intervals of approx. 12 months. Every re-calibration at the factory also includes a comprehensive and free checking of all system parameters.

During the first re-calibration a service file is started automatically in which every re-calibration and all extra services are recorded.

The instrument requires almost no maintenance, because all parts which are moveable are extremely robust. There are no parts which has to be serviced by the user.

During each re-calibration the functioning of the integrated overflow valves is checked and the lithium battery in the processor board, whose use is only essential for the time of the clock and the date, is changed if necessary.

To clean the membrane keyboard and the display, use only customary plastic or glass cleaning agents in compliance with the guidelines of the manufacturer. Use clothes which are not prone to generate fluffs.



Warning

**Before cleaning the surface of the instrument, it has to sure that it is not pressurized and in the VENT-mode, the power switched off and the power supply disconnected.**

## 9. Dismantling of the system



Warning

Work on electrical or pneumatic/hydraulic equipment must only be carried out by qualified and authorised technical staff, observing the corresponding safety regulations.

**When dismantling the system please proceed as follows:**

1. Make sure that there is no positive or negative overpressure on the system and that all parts of the appliance are at room temperature.
2. Switch off the system from the main switch at the front (top right).
3. First pull out the mains cable from the main socket and then from the power supply input socket the system.
4. Disconnect the pressure connections.



Warning

If a connection next to a **SWAGELOK®** - connection is to be disconnected, overturning or loosening of the **SWAGELOK®** - connection must be prevented with suitable tools.

5. Remove the system as necessary.
6. Make sure that the system is free of any pressure medium.
7. Protect connections with the protective caps supplied.

## 10. Transport of the system



Warning

**Before the system is shipped all remains of any medium stuck to it must be removed. This is particularly important if the medium is a health hazard such as a corrosive, toxic, carcinogenic, radioactive, etc.**

The precision measuring system CPC8000 must only be shipped in its own special transport box. If necessary, please ask for a proper transport box:

Tel. +49 (0) 93 72/132-9986

Fax. +49 (0) 93 72/132-217

E-mail: [testequip@wika.de](mailto:testequip@wika.de)

In the transport box there is insulating material and a set of plastic protection caps for the pressure connections.

### **Please follow the following instructions to prevent damage.**

1. Put the supplied plastic protection caps on the pressure connections.
2. Wrap the system in anti-static plastic foil.
3. Using the insulating material, place the system in the box in such a way that there is about the same amount of insulating material on all sides of the transport box.
4. If possible add a bag of desiccant to the box
5. Under the Enclosure of the manual there is a shipping form that you should fill in completely and legibly and add to the transport box.
6. Make sure that the shipment is marked as transport of a highly sensitive measuring instrument.

### **The shipping address is:**

WIKA Alexander Wiegand SE & Co. KG  
Abteilung: Kalibriertechnik  
Alexander Wiegand Strasse  
D-63911 Klingenberg



### 11. Storage of the system



Warning

Before the system is stored all remains of any medium stuck to it must be removed. This is particularly important if the medium is a health hazard such as a corrosive, toxic, carcinogenic, radioactive, etc.

**The storage place must satisfy the following conditions:**

- Ambient temperature: 0 to 70 °C
- Humidity: 35 to 85 % relative humidity without condensation

**Avoid the following influences:**

- Direct sunlight or vicinity to hot objects
- Mechanical vibration
- Soot, steam, dust and corrosive gasses
- Explosion-hazard environment, inflammable atmosphere

The system should be stored in its original transport box, in a place that meets the conditions listed above.

**Please follow the following instructions to avoid damage.**

1. Put the supplied plastic protection caps on the pressure connections.
2. Wrap the system in anti-static plastic foil.
3. Using the insulating material, place the system in the box in such a way that there is about the same amount of insulating material on all sides of the transport box.
4. If the system is stored for a longer time (more than 30 days) add a bag with desiccant to the box.

## 12. Placing out of service



Warning

**Before the system is shipped all remains of any medium stuck to it must be removed. This is particularly important if the medium is a health hazard such as a corrosive, toxic, carcinogenic, radioactive, etc.**

When placing the system out of service, please dismantle it according to the instructions in the manual under the chapter: Dismantling of the system



Notice

When disposing of the system please observe the legal and local regulations in force.

For the final disposal of the system a special firm qualified for this is to be commissioned.

## 13. Units and Conversion Table of the SETUP-menu point: units

ID	Name	Unit	p [bar] / p [Unit]	p [Unit] / p [bar]
0	bar	bar	1.000000E+00	1.000000E+00
1	Millibar	mbar	1.000000E-03	1.000000E+03
2	Pascal	Pa	1.000000E-05	1.000000E+05
3	pound-force / inch <sup>2</sup>	psi	6.894757E-02	1.450377E+01
4	Standard atmosphere (760 Torr)	atm	1.013250E+00	9.869233E-01
5	Technical atmosphere	kp/cm <sup>2</sup>	9.806650E-01	1.019716E+00
6	pound-force / foot <sup>2</sup>	lbf/ft <sup>2</sup>	4.788026E-04	2.088543E+03
7	Kilopond / cm <sup>2</sup>	kp/cm <sup>2</sup>	9.806650E-01	1.019716E+00
8	Centimetres water column 4 °C	cmWS (4 °C)	9.806380E-04	1.019744E+03
9	Inch water column 4 °C	inH <sub>2</sub> O (4 °C)	2.490820E-03	4.014742E+02
10	Inch water column 60 °F	inH <sub>2</sub> O (60 °F)	2.488400E-03	4.018647E+02
11	Fuß water column 4 °C	ftH <sub>2</sub> O (4 °C)	2.988980E-02	3.345623E+01
12	Micrometer mercury column 0 °C (Micron)	µmHg (0 °C)	1.333224E-06	7.500615E+05
13	Millimeter mercury column 0 °C (Torr)	mmHg (0 °C)	1.333224E-03	7.500615E+02
14	Centimetres mercury column 0 °C	cmHg (0 °C)	1.333224E-02	7.500615E+01
15	Inch mercury column 0 °C	inHg (0 °C)	3.386380E-02	2.953006E+01
16	Inch mercury column 60 °F	inHg (60 °F)	3.376850E-02	2.961340E+01

## WIKA Worldwide

### Europe

#### Austria

WIKKA Messgerätevertrieb  
Ursula Wiegand GmbH & Co. KG  
1230 Vienna  
Tel. (+43) 1 86916-31  
Fax: (+43) 1 86916-34  
E-mail: info@wika.at  
www.wika.at

#### Benelux

WIKKA Benelux  
6101 WX Echt  
Tel. (+31) 475 535-500  
Fax: (+31) 475 535-446  
E-mail: info@wika.nl  
www.wika.nl

#### Bulgaria

WIKKA Bulgaria EOOD  
Bul. „Al. Stamboliiski“ 205  
1309 Sofia  
Tel. (+359) 2 82138-10  
Fax: (+359) 2 82138-13  
E-mail: t.antonov@wika.bg

#### Croatia

WIKKA Croatia d.o.o.  
Hrastovicka 19  
10250 Zagreb-Lucko  
Tel. (+385) 1 6531-034  
Fax: (+385) 1 6531-357  
E-mail: info@wika.hr

#### Finland

WIKKA Finland Oy  
00210 Helsinki  
Tel. (+358) 9 68249-20  
Fax: (+358) 9 68249-270  
E-mail: info@wika.fi  
www.wika.fi

#### France

WIKKA Instruments s.a.r.l.  
95610 Eragny-sur-Oise  
Tel. (+33) 1 343084-84  
Fax: (+33) 1 343084-94  
E-mail: info@wika.fr  
www.wika.fr

#### Germany

WIKKA  
Alexander Wiegand SE & Co. KG  
63911 Klingenberg  
Tel. (+49) 9372 132-0  
Fax: (+49) 9372 132-406  
E-mail: info@wika.de  
www.wika.de

#### Italy

WIKKA Italiana SRL  
20020 Arese (Milano)  
Tel. (+39) 02 9386-11  
Fax: (+39) 02 9386-174  
E-mail: info@wika.it  
www.wika.it

#### Poland

WIKKA Polska S.A.  
87-800 Wloclawek  
Tel. (+48) 542 3011-00  
Fax: (+48) 542 3011-01  
E-mail: info@wikapolska.pl  
www.wikapolska.pl

#### Romania

WIKKA Instruments Romania  
S.R.L.  
Bucuresti, Sector 5  
Calea Rahovei Nr. 266-268  
Corp 61, Etaj 1  
Tel. (+40) 21 4048327  
Fax: (+40) 21 4563137  
E-mail: m.anghel@wika.ro

#### Russia

ZAO WIKKA MERA  
127015 Moscow  
Tel. (+7) 495 64801-80  
Fax: (+7) 495 64801-81  
E-mail: info@wika.ru  
www.wika.ru

#### Serbia

WIKKA Merna Tehnika d.o.o.  
Sime Solaje 15  
11060 Belgrade  
Tel. (+381) 11 2763-722  
Fax: (+381) 11 7536-74  
E-mail: info@wika.co.yu  
www.wika.co.yu

#### Spain

Instrumentos WIKKA, S.A.  
C/Josep Carner, 11-17  
08205 Sabadell (Barcelona)  
Tel. (+34) 902902577  
Fax: (+34) 933938666  
E-mail: info@wika.es  
www.wika.es

#### Switzerland

Manometer AG  
6285 Hitzkirch  
Tel. (+41) 41 91972-72  
Fax: (+41) 41 91972-73  
E-mail: info@manometer.ch  
www.manometer.ch

#### Turkey

WIKKA Instruments Istanbul  
Basinc ve Sicaklik Ölçme Cihazlari  
Ith. Ihr. ve Tic. Ltd. Sti.  
Bayraktar Bulvarı No. 21  
34775 Yukari Dudullu - Istanbul  
Tel. (+90) 216/415 90 66  
Fax: (+90) 216/415 90 97  
E-mail: info@wika.com.tr  
www.wika.com.tr

#### Ukraine

WIKKA Pribor GmbH  
83016 Donetsk  
Tel. (+38) 062 34534-16  
Fax: (+38) 062 34534-17  
E-mail: info@wika.ua  
www.wika.ua

#### United Kingdom

WIKKA Instruments Ltd  
Merstham, Redhill RH13LG  
Tel. (+44) (0) 1737644-008  
Fax: (+44) (0) 1737644-403  
E-mail: info@wika.co.uk  
www.wika.co.uk

### North America

#### Canada

WIKKA Instruments Ltd.  
Head Office  
Edmonton, Alberta, T6N 1C8  
Tel. (+1) 780 4637035  
Fax: (+1) 780 4620017  
E-mail: info@wika.ca  
www.wika.ca

#### Mexico

Instrumentos WIKKA Mexico  
S.A. de C.V.  
01210 Mexico D.F.  
Tel. (+52) 555 02053-00  
Fax: (+52) 555 02053-01  
E-mail: ventas@wika.com  
www.wika.com.mx

#### USA

WIKKA Instrument Corporation  
Lawrenceville, GA 30043  
Tel. (+1) 770 5138200  
Fax: (+1) 770 3385118  
E-mail: info@wika.com  
www.wika.com

WIKKA Instrument Corporation  
Electrical Temperature Division  
950 Hall Court  
Deer Park, TX 77536  
Tel. (+1) 713 47500-22  
Fax: (+1) 713 47500-11  
E-mail: info@wikaetemp.com  
www.wika.com

Mensor Corporation  
201 Barnes Drive  
San Marcos, TX 78666  
Tel. (+1) 512 396420015  
Fax: (+1) 512 3961820  
E-mail: sales@mensor.com  
www.mensor.com

### South America

#### Argentina

WIKKA Argentina S.A.  
Buenos Aires  
Tel. (+54) 11-4730 18 00  
Fax: (+54) 11-4761 00 50  
E-mail: info@wika.com.ar  
www.wika.com.ar

#### Brazil

WIKKA do Brasil Ind. e Com.  
Ltda.  
CEP 18560-000 Iperó - SP  
Tel. (+55) 15-3459 97 00  
Fax: (+55) 15-3266 16 50  
E-mail: marketing@wika.com.br  
www.wika.com.br

### Asia

#### China

WIKKA International Trading  
(Shanghai) Co., Ltd.  
200001 Shanghai  
Tel. (+86) 21 538525-72  
Fax: (+86) 21 538525-75  
E-mail: info@wika.com.cn

#### India

WIKKA Instruments India Pvt.  
Ltd.  
Village Kesnand, Wagholi  
Pune - 412 207  
Tel. (+91) 20 66293-200  
Fax: (+91) 20 66293-325  
E-mail: sales@wika.co.in  
www.wika.co.in

#### Japan

WIKKA Japan K. K.  
Tokyo 105-0023  
Tel. (+81) 3 543966-73  
Fax: (+81) 3 543966-74  
E-mail: t-shimane@wika.co.jp

#### Kazakhstan

TOO WIKKA Kazakhstan  
050050 Almaty  
Tel. (+7) 32 72330848  
Fax: (+7) 32 72789905  
E-mail: info@wika.kz

#### Korea

WIKKA Korea Ltd.  
Seoul 153-023  
Tel. (+82) 2 86905-05  
Fax: (+82) 2 86905-25  
E-mail: info@wika.co.kr

#### Malaysia

WIKKA Instrumentation (M)  
Sdn. Bhd.  
47100 Puchong, Selangor  
Tel. (+60) 3 806310-80  
Fax: (+60) 3 806310-70  
E-mail: info@wika.com.my  
www.wika.com.my

#### Singapore

WIKKA Instrumentation Pte. Ltd.  
569625 Singapore  
Tel. (+65) 68 4455-06  
Fax: (+65) 68 4455-07  
E-mail: info@wika.com.sg  
www.wika.com.sg

#### Taiwan

WIKKA Instrumentation Taiwan Ltd.  
Pinjen, Taoyuan  
Tel. (+886) 3 4206052  
Fax: (+886) 3 4900080  
E-mail: info@wika.com.tw  
www.wika.com.tw

### Africa / Middle East

#### Egypt

WIKKA Near East Ltd.  
El-Serag City Towers  
-Tower#2 - Office #67-  
Nasr City Cairo  
Tel. (+20) 2 227 33 140  
Fax: (+20) 2 227 03 815  
E-mail: wika.repcairo@wika.de  
www.wika.com.eg

#### South Africa

WIKKA Instruments (Pty.) Ltd.  
Gardenvue, Johannesburg 2047  
Tel. (+27) 11-621 00 00  
Fax: (+27) 11-621 00 59  
E-mail: sales@wika.co.za  
www.wika.co.za

#### United Arab Emirates

WIKKA Middle East FZE  
Jebel Ali, Dubai  
Tel. (+971) 4 8839-090  
Fax: (+971) 4 8839-198  
E-mail: wikame@emirates.net.ae

### Australia

#### Australia

WIKKA Australia Pty. Ltd.  
Rydalmere, NSW 2116  
Tel. (+61) 2 88455222  
Fax: (+61) 2 96844767  
E-mail: sales@wika.com.au  
www.wika.com.au

#### New Zealand

Process Instruments Limited  
Unit 7 / 49 Sainsbury Road  
St Lukes - Auckland 1025  
Tel. (+64) 9 8479020  
Fax: (+64) 9 8465964  
E-mail: info@wika.co.nz  
www.wika.co.nz



#### WIKKA Alexander Wiegand SE & Co. KG

Alexander-Wiegand-Straße 30  
63911 Klingenberg • Germany  
Phone (+49) 93 72/132-9986  
Fax (+49) 93 72/132-217  
E-Mail testequip@wika.de  
www.wika.de