

Surface resistance thermometer Model TR50

WIKA data sheet TE 60.50



for further approvals
see page 2

Applications

To measure surface temperatures on flat surfaces or pipes, in both laboratory and industrial applications

Special features

- Sensor ranges up to max. 250 °C (482 °F)
Option: 600 °C (1,112 °F)
- Easily exchanged, no thermowell necessary
- For screw-fitting, welding or using a tightening strap
- Cable from PVC, silicone or PTFE
- Explosion-protected versions

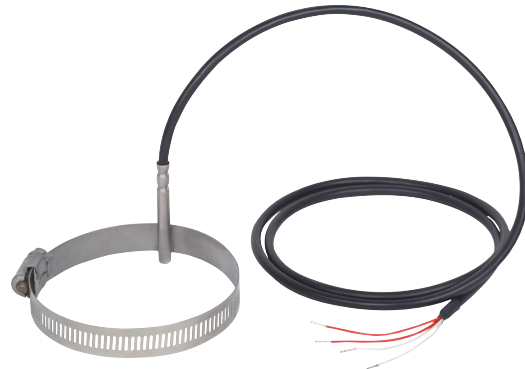
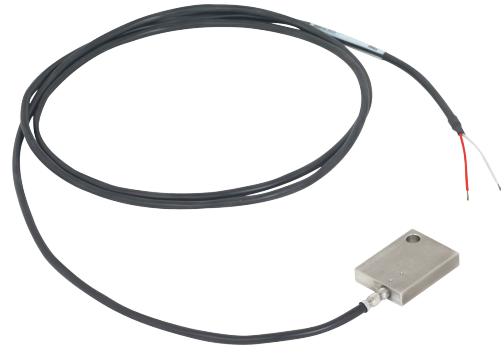

Fig. top: Model TR50 with metal contact block
Fig. bottom: Model TR50 with tightening strap

Description

Probe

In the variants for flat surfaces, the probe is fitted within a contact block. This can be screwed or welded onto the vessel surface. Variants for pipes are secured using a tightening strap.

Cable







There are various insulating materials available to suit any particular environmental conditions. The cable end is made up, ready for connection, but can also be fitted with a connector or connected to a field case, as options.









Explosion protection (option)

The permissible power, P_{max} , as well as the permissible ambient temperature, for the respective category can be seen on the EC-type examination certificate, the certificate for hazardous areas or in the operating instructions.

The internal inductance ($L_i = 1 \mu\text{H/m}$) and capacitance ($C_i = 200 \text{ pF/m}$) for cable probes are found on the product label and they should be taken into account when connecting to an intrinsically safe power supply.

Approvals (explosion protection, further approvals)

Logo	Description	Country
 	EU declaration of conformity <ul style="list-style-type: none"> ■ RoHS directive ■ ATEX directive (option) Hazardous areas <ul style="list-style-type: none"> - Ex i Zone 0 gas [II 1G Ex ia IIC T1 ... T6 Ga] Zone 1 mounting to zone 0 gas [II 1/2G Ex ia IIC T1 ... T6 Ga/Gb] Zone 1 gas [II 2G Ex ia IIC T1 ... T6 Gb] Zone 20 dust [II 1D Ex ia IIIC T125 ... T65 °C Da] Zone 21 mounting to zone 20 dust [II 1/2D Ex ia IIIC T125 ... T65 °C Da/Db] Zone 21 dust [II 2D Ex ia IIIC T125 ... T65 °C Db] - Ex n Zone 2 gas [II 3G Ex nA IIC T1 ... T6 Gc X] Zone 22 dust [II 3D Ex tc IIIC T440 ... T80 °C Dc X] 	European Union
 	IECEx (option) (in conjunction with ATEX) Hazardous areas <ul style="list-style-type: none"> - Ex i Zone 0 gas [Ex ia IIC T1 ... T6 Ga] Zone 1 mounting to zone 0 gas [Ex ia IIC T1 ... T6 Ga/Gb] Zone 1 gas [Ex ia IIC T1 ... T6 Gb] Zone 20 dust [Ex ia IIIC T125 ... T65 °C Da] Zone 21 mounting to zone 20 dust [Ex ia IIIC T125 ... T65 °C Da/Db] Zone 21 dust [Ex ia IIIC T125 ... T65 °C Db] 	International
	FM Hazardous areas <ul style="list-style-type: none"> - Ex NI Class I, Div 2 [NI / I / 2 / BCD / T6, Type 4/4x] 	USA
	CSA Hazardous areas <ul style="list-style-type: none"> - Ex NI Class I, Div 2 [NI / I / 2 / BCD / T6, Type 4/4x] 	USA and Canada
	EAC (option) Hazardous areas <ul style="list-style-type: none"> - Ex i Zone 0 gas [0 Ex ia IIC T3/T4/T5/T6] Zone 1 gas [1 Ex ib IIC T3/T4/T5/T6] Zone 20 dust [DIP A20 Ta 65 °C/Ta 95 °C/Ta 125 °C] Zone 21 dust [DIP A21 Ta 65 °C/Ta 95 °C/Ta 125 °C] - Ex n Zone 2 gas [Ex nA IIC T6 ... T1] Zone 22 dust [DIP A22 Ta 80 ... 440 °C] 	Eurasian Economic Community

Logo	Description	Country
	INMETRO (option) Hazardous areas - Ex i Zone 0 gas [Ex ia IIC T3 ... T6 Ga] Zone 1 mounting to zone 0 gas [Ex ib IIC T3 ... T6 Ga/Gb] Zone 1 gas [Ex ib IIC T3 ... T6 Gb] Zone 20 dust [Ex ia IIIC T125 ... T65 °C Da] Zone 21 mounting to zone 20 dust [Ex ib IIIC T125 ... T65 °C Da/Db] Zone 21 dust [Ex ib IIIC T125 ... T65 °C Db]	Brazil
	NEPSI (option) Hazardous areas - Ex i Zone 0 gas [Ex ia IIC T3 ~ T6] Zone 1 mounting to zone 0 gas [Ex ia/ib IIC T3 ~ T6] Zone 1 gas [Ex ib IIC T3 ~ T6]	China
	KCs - KOSHA (option) Hazardous areas - Ex i Zone 0 gas [Ex ia IIC T4 ... T6] Zone 1 gas [Ex ib IIC T4 ... T6]	South Korea
-	PESO (option) Hazardous areas - Ex i Zone 0 gas [Ex ia IIC T1 ... T6 Ga] Zone 1 mounting to zone 0 gas [Ex ib IIC T3 ... T6 Ga/Gb] Zone 1 gas [Ex ib IIC T3 ... T6 Gb]	Indien
	DNOP - MakNII (option) Hazardous areas - Ex i Zone 0 gas [II 1G Ex ia IIC T3, T4, T5, T6 Ga] Zone 1 gas [II 2G Ex ia IIC T3, T4, T5, T6 Gb] Zone 20 dust [II 1D Ex ia IIIC T65, T95, T125 °C Da] Zone 21 dust [II 2D Ex ib IIIC T125 ... T65 °C Db]	Ukraine
	GOST (option) Metrology, measurement technology	Russia
	KazInMetr (option) Metrology, measurement technology	Kazakhstan
-	MTSCHS (option) Permission for commissioning	Kazakhstan
	BelGIM (option) Metrology, measurement technology	Belarus
	UkrSEPRO (option) Metrology, measurement technology	Ukraine
	Uzstandard (option) Metrology, measurement technology	Uzbekistan

Instruments marked with "ia" may also be used in areas only requiring instruments marked with "ib" or "ic".
 If an instrument with "ia" marking has been used in an area with requirements in accordance with "ib" or "ic", it can no longer be operated in areas with requirements in accordance with "ia" afterwards.

Approvals and certificates, see website

Sensor

Sensor connection method

- 2-wire
- 3-wire
- 4-wire

Sensor tolerance value per IEC 60751

- Class B
- Class A
- Class AA

Combinations of 2-wire connection and class A or class AA are not allowed.

For detailed specifications for Pt100 sensors, see Technical information IN 00.17 at www.wika.com.

Metallic probe

Material: Stainless steel

Diameter: 3 or 6 mm

Length: selectable

Regardless of the design, the first 60 mm of the probe tip must not be bent.

Surface resistance thermometers can be constructed in two different ways:

■ Tubular design

The tubular design features a rigid construction to the metal probe tip; therefore, tubular designs must not be bent. Internally, the measuring resistor is connected directly to an insulated supply line; this is why tubular design TR50 resistance thermometers can only be used up to the temperatures specified for the supply line (see operating temperatures).

■ Sheathed design

In sheathed resistance thermometers the flexible part of the sensor is a mineral-insulated cable (MI-cable). It consists of a stainless steel outer sheath, which contains the insulated internal leads, embedded within a high-density ceramic compound.

The measuring resistance is connected directly to the internal leads of the sheathed cable and is, therefore, also suitable for use at higher temperatures.

Due to their flexibility and the small possible diameters, sheathed resistance thermometers can also be used in locations that are not easily accessible, since, with the exception of the probe tip and the transition of the connection cable, the sheath can be bent to a radius of three times the diameter of the cable.

Maximum working temperatures

The maximum working temperature for these thermometers is limited by different parameters.

If the temperature to be measured inside the sensor measuring range is higher than the permissible temperature at the connection cable, the connector or the transition point, the metallic part of the sensor (mineral-insulated cable) must be long enough to place the critical components outside of the hot zone. The lowest of the maximum working temperatures of connection line, cable transition or connector must be observed here.

■ Sensor

Measuring element

Pt100 (measuring current: 0.1 ... 1.0 mA) ¹⁾

Connection method	
Single elements	1 x 2-wire 1 x 3-wire 1 x 4-wire
Dual elements	2 x 2-wire 2 x 3-wire 2 x 4-wire ²⁾

Tolerance value of the measuring insert per IEC 60751		
Class	Sensor construction	
	Wire-wound	Thin-film
Class B	-196 ... +600 °C	-50 ... +500 °C
	-196 ... +450 °C	-50 ... +250 °C
Class A ³⁾	-100 ... +450 °C	-30 ... +300 °C
Class AA ³⁾	-50 ... +250 °C	0 ... 150 °C

¹⁾ For detailed specifications for Pt100 sensors, see Technical information IN 00.17 at www.wika.com.

²⁾ Not with 3 mm diameter

³⁾ Not for 2-wire connection method

■ Connection cable and single wires

At any point on the connection cable, the maximum temperature that may be attained is that for which the connection cable is specified. The sensor itself (see page 4) can potentially withstand higher temperatures.

For the common connection lines the following maximum operating temperatures apply:

PVC	-20 ... +100 °C
Silicone	-50 ... +200 °C
PTFE	-50 ... +250 °C
Fibreglass	-50 ... +400 °C

Since, in the tubular design variant, an isolated cable is also fitted within the metal probe, the operating limits of the connecting cable apply.

■ Transition from the metal part of the thermometer to the connection cable

The temperature at the transition may be further limited by the use of a potted sealing compound.

Temperature range of the potting compound: -40 ... +150 °C

Option: 250 °C

(other variants on request)

Temperature range of the special low-temperature version:

-60 ... +120 °C⁴⁾

4) only available with selected approvals

■ Connector (option)

With the option of a coupler connector fitted the maximum permissible temperature range is:

Lemos: -55 ... +250 °C

Binder, Amphenol: -40 ... +85 °C

Transition

The junction between the metal part of the probe and the connecting cable or wire is either rolled or potted, depending on the design. This area should not be immersed within the process and must not be bent. Compression fittings should not be attached to the transition. The version and dimensions of the transition depend largely on the combination between supply line and metal sensor and the sealing requirements.

The dimension T describes the length of the transition.

Criterion	Dimensions T ¹⁾ in mm	Ø transition in mm
Probe Ø = transition sleeve Ø	40	identical to probe
Ø 2 ... 4.5 mm with crimped transition sleeve	45	6
Ø 6 mm with crimped transition sleeve	45	7
Ø 6 mm with crimped transition sleeve ²⁾	45	8
Ø 8 mm with crimped transition sleeve	45	10

For operating temperatures < -40 °C the transition sleeve is designed as follows:

Criterion	Dimension T in mm	Ø transition sleeve in mm
Probe Ø = transition sleeve Ø	60	Identical to probe
Ø 2 ... 4.5 mm with crimped transition sleeve	60	8
Ø 6 mm with crimped transition sleeve	60	8
Ø 8 mm with crimped transition sleeve	60	10

1) The transition sleeve is generally 60 mm long for 2 x 4-wire sensor connection method.

2) With a large number of wires (e.g. 2 x 3-wire and shielding)

Connection lead

There are various insulating materials available to suit any particular environmental conditions.

The cable end is made up, ready for connection, but can also be fitted with a connector or connected to a field case, as options.

Connection cable (standard)

- Wire material: Copper (wire)
- Wire cross-section: Approx. 0.22 mm² (standard design)
- Number of wires: Dependent on the connection method
- Insulation material: PVC, silicone, PTFE or glass fibre
- Screen (option)

IP ingress protection

Standard versions: up to IP65

(depending on cable sheath material and number of wires)

Special versions (on request): up to IP67

Connection leads with a glass-fibre sheath cannot be combined with an explosion-proof design.

Process connection

Metal contact block

Design: Contact block for screwing or welding to a flat surface

Material: Stainless steel

Dimensions: see drawing

Washer

Design: Centrally-drilled washer

Material: Stainless steel

Dimensions: see drawing

Tightening strap

Design: Tightening strap

Material: Stainless steel

Dimensions: see drawing

Weld-on sheet

Design: Weld-on sheet

Material: Stainless steel

Dimensions: see drawing

other versions on request

Dimensions in mm

Metal contact block with bore

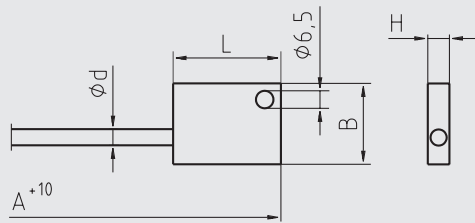

11362600.01

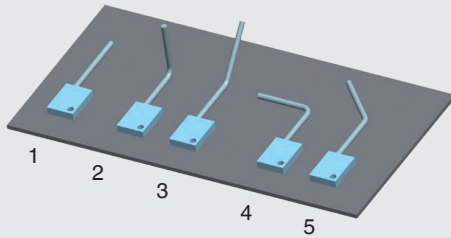

Washer

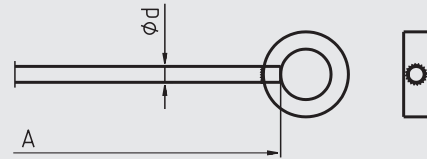

11362626.01

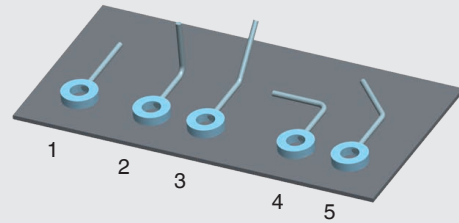

Tightening strap

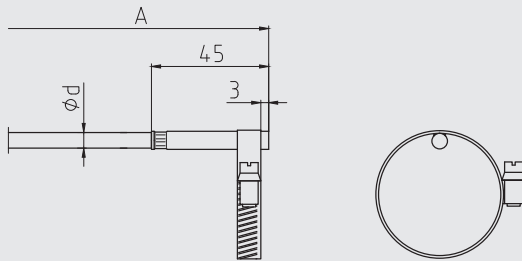

11362597.03

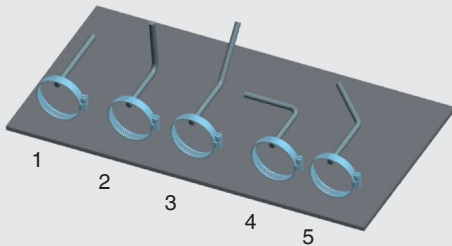

Weld-on sheet

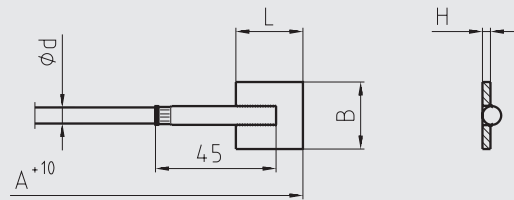

11362618.02

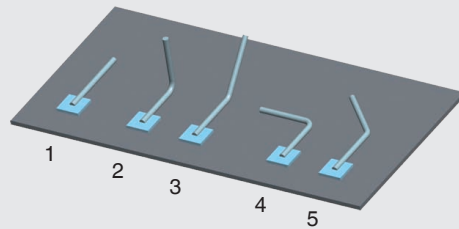

Bending direction (MI cable)

- 1 Standard version straight
- 2 Standard version 90° bent
- 3 Standard version 45° bent
- 4 Option (ask for delivery time)
- 5 Option (ask for delivery time)

Please note:

The complete length, A, must always be viewed in relation to the drawings on pages 8 and 9.

Process connection	Dimensions in mm	
	Width x length x height	Outer diameter x inner diameter x thickness
	(B x L x H)	(AD x ID x d)
Metal contact block with bore d = 6.5 mm	30 x 40 x 8	-
Washer	-	38.1 x 19.1 x 9.5
Weld-on sheet	25 x 25 x 3.0	-
Tightening strap	-	11 ... 15
	-	13 ... 25
	-	23 ... 62
	-	60 ... 93
	-	91 ... 125
-	123 ... 158	

Cable end design

The dimension A defines the probe length. The dimension W describes the length of the connecting wire. L is the length of the free cable ends. The dimension T describes the transition (if present). T is always a constituent of the length W or L (see table on page 4).

Connection with single wires

Cable length 150 mm, other lengths on request
 Cu strands 0.22 mm², PTFE or glass-fibre insulated, number of leads dependent on the number of sensors and the sensor connection method, bare wire ends, other designs on request

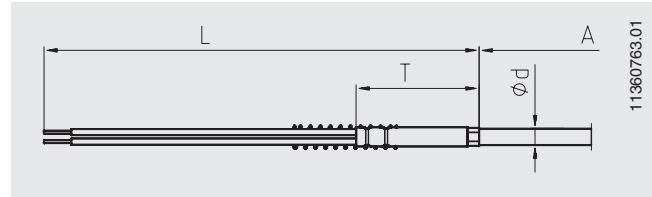

With connection cable

Cable and probe are permanently connected to each other.
 Cable length and insulation materials to customer specification.
 Cu strands 0.22 mm², number of leads dependent on the number of sensors and the sensor connection method, bare wire ends

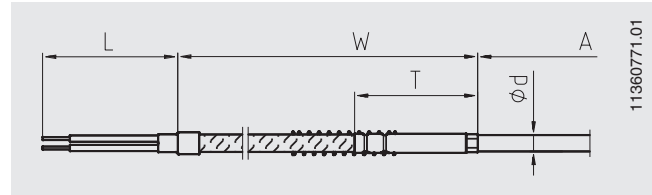

With connector fitted to connection cable

The optional connection connector is fitted to a flexible connection cable.

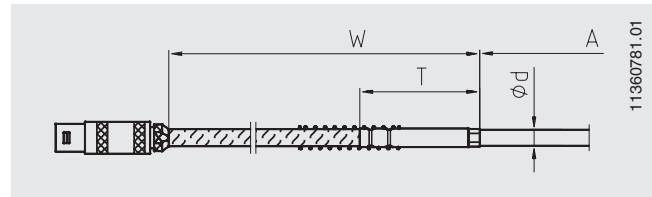

Designs with bare connecting wires

The internal leads of the mineral-insulated wire protrude.
 L = 20 mm (standard)

The length of the bare connection wires can be matched to customer requirements. These bare internal leads are made from solid wire, and so are not suitable to be run over long distances.

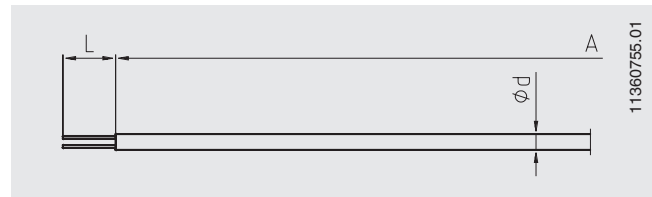

Design with connector fitted directly to the probe

These designs are based on the design with bare connection wires. The connector is fitted directly to the metallic probe.

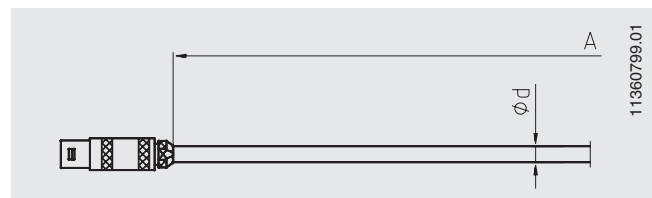

Version with connected field case

The connection cable is connected to the field case (plastic, ABS) via a cable gland. A second cable gland is mounted for the cable outlet. An aluminium case is available as an option.

Ambient temperature at case:

-40 ... +80 °C

Cable gland material:

- Plastic (standard)
- Metal (option)

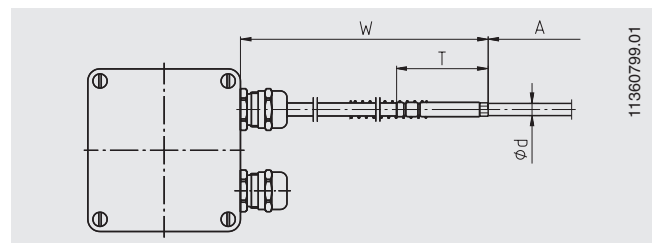

Angled probes

Surface resistance thermometers made from sheathed cable can be delivered in a pre-formed shape. In this case, the position of the bend is defined by a further dimension.

The dimension X describes the distance of the bend from the lower edge of the transition.

Other bend angles on request.

Strain relief loops are also possible on request.

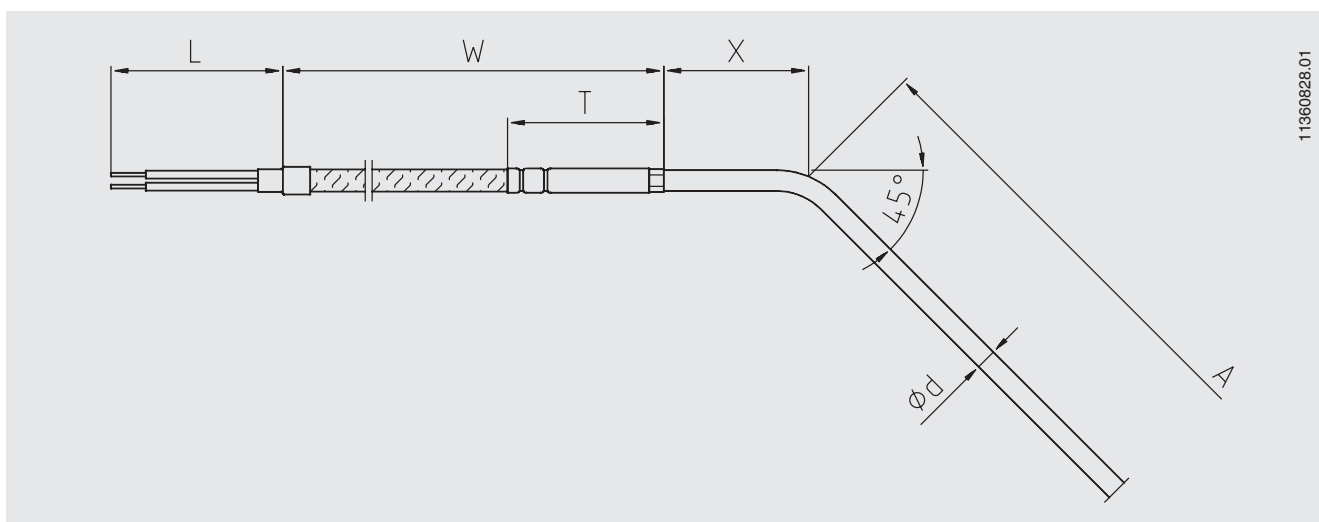
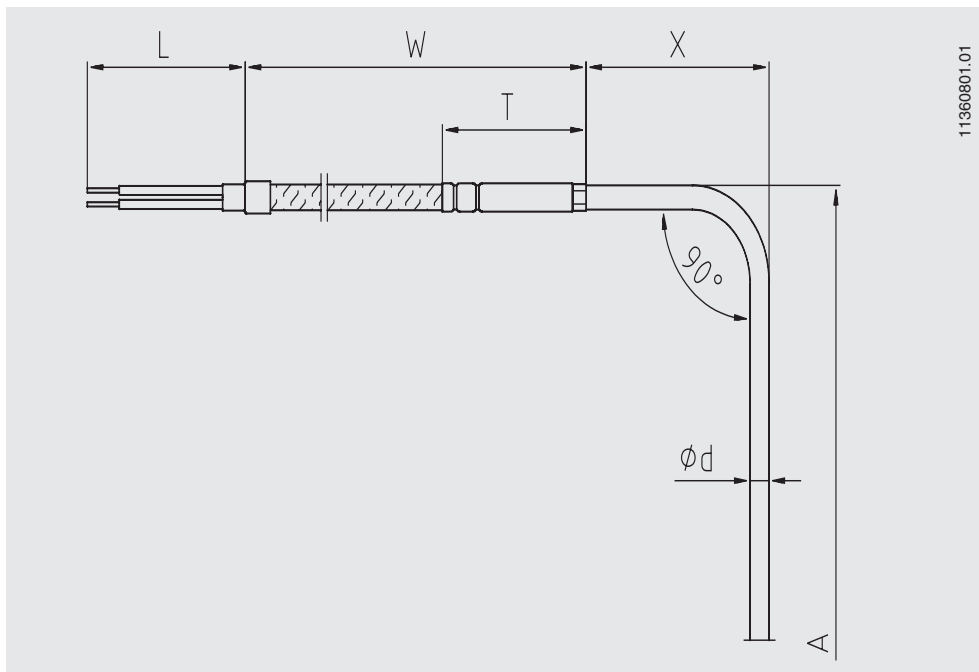

Connector (option)

Surface resistance thermometers can be supplied with connectors fitted.
The following options are available:

■ Screw-in-connector, Binder (male)

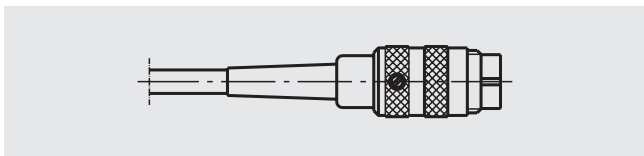

■ Screw-in-connector, Binder (female)

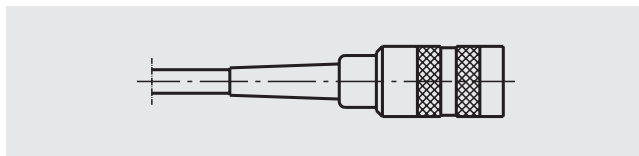

■ Lemosa connector size 1 S (male)

■ Lemosa connector size 2 S (male)

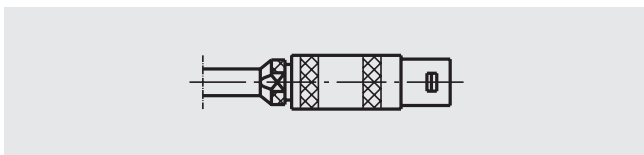

■ Lemosa coupling size 1 S (female)

■ Lemosa coupling size 2 S (female)

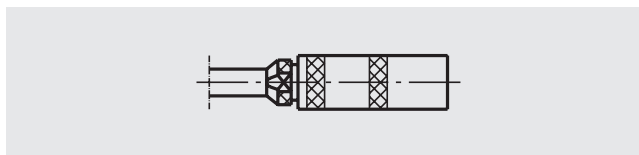

■ Spade lugs

(not suitable for versions with bare connecting wires)

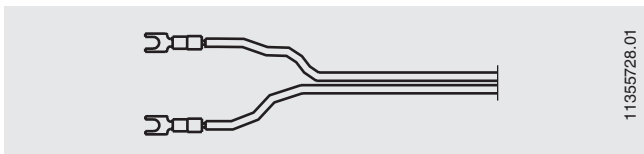

Other connector variants (sizes) on request.

Further options

Bend protector

A cable protector (spring or shrink hose) is used to protect the transition point from rigid probe to flexible connecting cable. This should always be used when a relative movement between the cable and the thermometer mounting is expected.

For designs to Ex n the use of bend protection is obligatory.

The standard length of the bend protection spring is 60 mm.

Electrical connection

Without connector

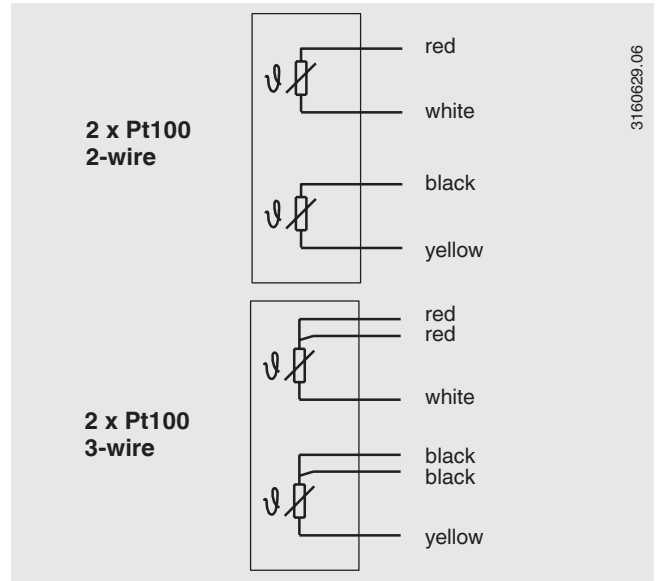
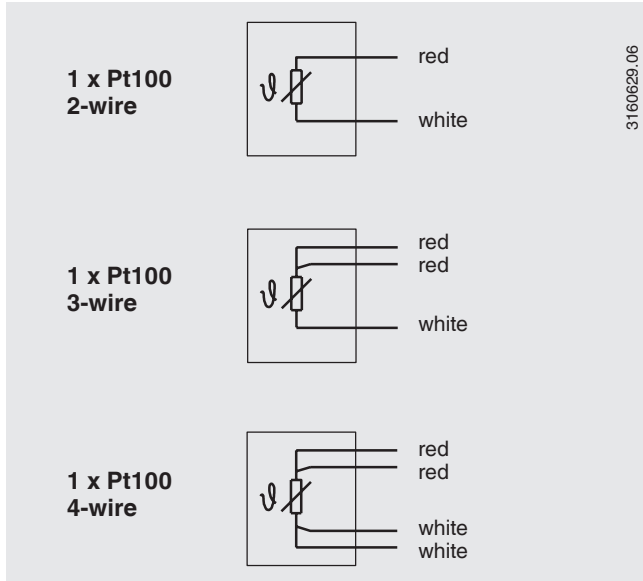

Lemosa connector

max. permissible temperature range: -55 ... +250 °C

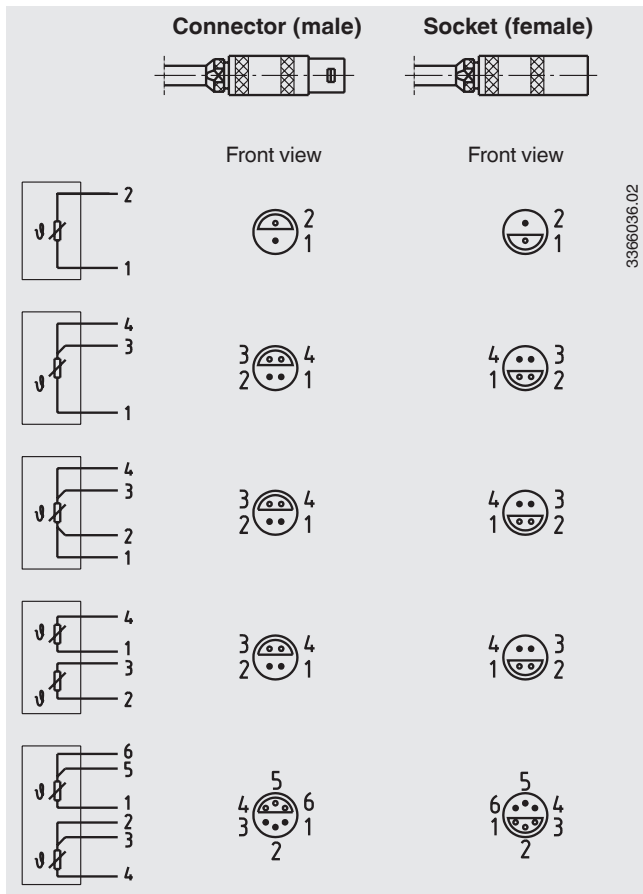

Screw-in-connector, (Amphenol, Binder)

max. permissible temperature range: -40 ... +85 °C

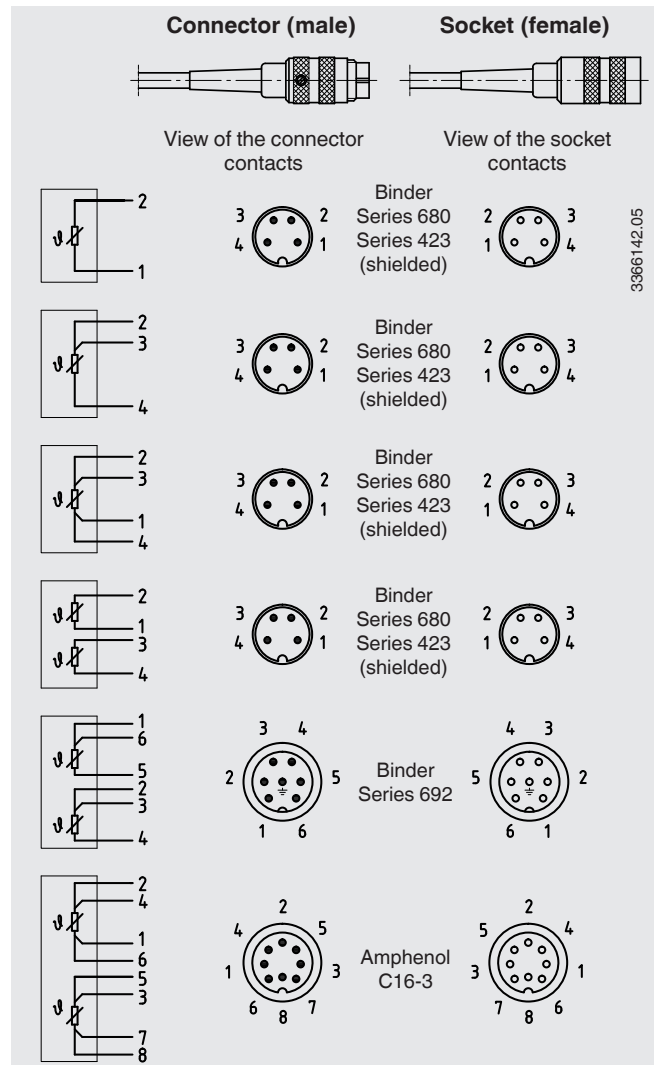

Mounting instructions

The basic requirements to ensure a perfect measurement result is to retain good thermal contact between the probe and the outside wall of the vessel or pipe. Minimal heat loss to the environment from both the probe and the measuring point is imperative.

The probe should have direct, metallic contact with the measuring point and sit firmly on the surface of the measuring point. Insulation must be applied at the installation site to avoid error due to heat loss. This insulation must have sufficient temperature resistance and is not included in the scope of delivery.

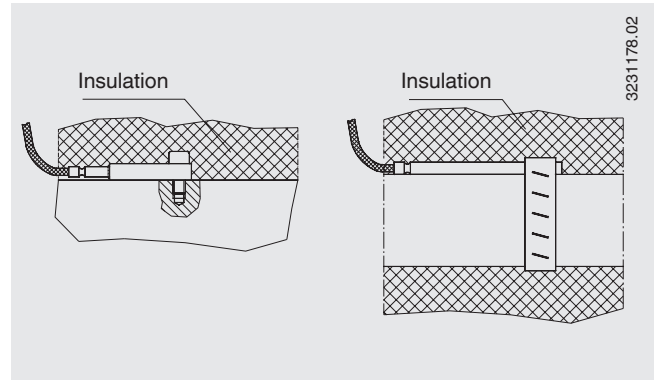

Certificates (option)

Certification type	Measuring accuracy	Material certificate
2.2 Test report	x	x

Other certificates on request.

Ordering information

Model / Process connection / Probe version / Explosion protection / Material of the process mounting / Probe diameter / Connection cable, sheath / Cable end version / Cable connection accessories / Measuring element / Connection method / Temperature range / Certificates / Options

© 10/2002 WIKA Alexander Wiegand SE & Co. KG, all rights reserved.
The specifications given in this document represent the state of engineering at the time of publishing.
We reserve the right to make modifications to the specifications and materials.

