

Pressure controller, high-end version, model CPC8000

EN



Pressure controller, high-end version, model CPC8000



© 2012, Mensor.

© 11/2024 WIKA Alexander Wiegand SE & Co. KG

All rights reserved.

Mensor is a registered trademark of Mensor.

WIKA® is a registered trademark in various countries.

All other brand and product names are trademarks or registered trademarks of their respective companies.

Prior to starting any work, read the operating instructions.

Keep for later use.

Contents

1. General information	7
1.1 Software licence agreement	8
1.2 Abbreviations, definitions.	8
1.3 Explanation of symbols	8
2. Safety	9
2.1 Intended use	9
2.1.1 Radio frequency emission notices.	9
2.1.2 FCC emission notice	10
2.2 Improper use	10
2.3 Personnel qualification	10
2.4 Personal protective equipment	10
2.5 Labelling, safety markings	11
3. Transport, packaging and storage	12
3.1 Transport	12
3.2 Packaging and storage	12
4. Design and function	13
4.1 Overview	13
4.2 Scope of delivery	13
4.3 Description	13
4.4 Front panel	14
4.4.1 Power switch	14
4.4.2 USB port	14
4.4.3 Information label.	14
4.4.4 Screen	14
4.5 Reference pressure transducers	15
4.6 Regulator ranges	16
4.7 Transducer selection	17
4.8 IntelliScale	17
4.8.1 IntelliScale 0.01 % IS-50	17
4.8.2 IntelliScale 0.008 % IS-33, optional	17
4.9 Accessories	18
4.9.1 Transport case	18
4.9.2 Rack-mounting kit	19
4.9.3 Barometric reference transducer	19
4.9.4 Pressure booster	19
5. Commissioning and operation	20
5.1 Unpacking the instrument	20
5.2 Requirements for the installation location	20
5.3 Connecting the instrument	21
5.3.1 Pressure connections	21
5.3.2 Pneumatic connections and pressure fittings	22
5.3.3 Electrical connections and interfaces	24

5.3.4	Notices regarding the electrical connections	25
5.3.4.1	Power supply	25
5.3.4.2	Interfaces	25
5.3.4.2.1	Pin assignment of the RS-232 interface	26
5.3.4.2.2	Pin assignment of the IEEE-488.2 interface	26
5.3.4.3	Input/output port	26
5.4	Replacing or removing the pressure transducers.	27
5.4.1	Pressure transducer location	28
5.4.2	Side panel removal.	29
5.5	Switching on the CPC8000	29
6.	Operation via menu functions	30
6.1	General information	30
6.2	Switching on	30
6.3	Applications and their functions	30
6.3.1	Buttons, keys, switches, tabs, and further functions	31
6.3.1.1	Main screen features	31
6.3.1.2	Screen navigation	31
6.3.2	Map of the main screen features	32
6.3.3	Autorange / Range Hold	33
6.3.4	Displayed pressure value.	34
6.3.5	Set point button	34
6.3.6	Set point display.	34
6.3.7	Settings	35
6.3.8	Set point entry methods	35
6.3.8.1	Numeric keypad	36
6.3.8.2	Numeric keypad / Step	37
6.3.8.3	Percentage value	37
6.3.8.4	Digital step	38
6.3.8.5	Program data entry	39
6.3.9	Favourites	39
6.3.10	Status bar	40
6.3.11	Secondary and tertiary display	40
6.3.12	Limits	41
6.3.13	Bar graph	42
6.3.14	Pressure units	42
6.3.15	Pressure type	43
6.3.16	Zero/Tare button.	43
6.3.17	Operating modes	44
6.3.17.1	Measure mode	45
6.3.17.2	Control mode	47
6.3.17.3	Vent mode	49
6.3.17.4	State of the isolation valves when the CPC8000 is off	50
7.	Basic settings	51
7.1	“General” tab	53
7.1.1	Language	53
7.1.2	Secondary and tertiary display	53
7.1.3	Calibration function.	54
7.1.4	Brightness.	55
7.1.5	Volume	55

7.1.6	Barometer (Units)	56
7.1.7	Load configuration	56
7.1.8	Save configuration	57
7.2	“Sensor” tab	58
7.2.1	Filter (sensor filter)	58
7.2.2	Resolution (decimal places)	58
7.2.3	Units	59
7.2.4	Rate units	59
7.2.5	User units	60
7.3	“Control” tab	61
7.3.1	Maximum and minimum limits	61
7.3.2	Stable limits	61
7.3.3	Rate maximum and minimum limits	62
7.3.4	Rate setpoint	63
7.3.5	Vent limit	63
7.3.6	Vent rate	64
7.4	“Remote” tab	64
7.4.1	Command set	65
7.4.2	IEEE-488 address	66
7.4.3	Ethernet settings	66
7.4.4	RS-232 settings	67
7.4.5	USB device setting	67
7.5	“Applications” tab	68
7.5.1	Passwords	68
7.5.2	Calibration of internal transducers	69
7.5.2.1	Calibration environment	69
7.5.2.2	Calibration pressure standards	69
7.5.2.3	Calibration media	69
7.5.2.4	Calibration setup	70
7.5.2.5	Calibration adjustment procedure	71
7.5.2.5.1	One-point calibration	72
7.5.2.5.2	Two-point calibration	72
7.5.2.5.3	Linearize	74
7.5.2.5.4	Height pressure correction (password-protected)	76
7.5.2.5.5	Remote zero calibration	76
7.5.3	Programs	77
7.5.4	Favourites	79
7.5.5	Digital I/O	79
7.5.5.1	Digital inputs	79
7.5.5.2	Digital outputs	80
7.5.6	Troubleshoot	80
7.5.7	Adaptation	81
7.6	Service menu	85
7.6.1	Tune	85
7.6.2	Admin	86
7.6.3	Software upgrade	87
7.7	“Info” tab	88

8. Remote operation	89
8.1 Software and functions	89
8.2 Remote command set.	89
8.3 Mensor command set	90
8.4 SCPI WIKA command set	99
8.5 SCPI error messages and error codes	102
8.6 Error emulation – PCS 400 emulated commands	102
9. Faults	105
10. Maintenance, cleaning and calibration	106
10.1 Maintenance	106
10.1.1 Changing the fuses.	106
10.1.2 Position of the fuses	106
10.2 Cleaning	107
10.3 Calibration.	107
10.3.1 Calibration services	107
10.3.2 Certifications and accreditations	107
11. Dismounting, return and disposal	108
11.1 Dismounting	108
11.2 Return	108
11.3 Disposal	109
12. Specifications	110
12.1 Reference pressure transducer	110
12.2 Barometric reference	110
12.3 Base instrument.	111
12.4 Control parameter	111
12.5 Pressure connection	111
12.6 Communication	112
12.7 Voltage supply	112
12.8 Operating conditions	112
12.9 Approvals	113
12.10 Certificates	113
12.11 Dimensions in mm [in].	114
13. Accessories and spare parts	115
14. Annex	117
14.1 Measuring units (unit no.)	117
14.2 Conversion factors, bar	118
14.3 Conversion factors, PSI	119
14.4 Conversion factors, millitorr	120

Declarations of conformity can be found online at www.wika.com.

1. General information

1. General information

- The instrument described in the operating instructions has been designed and manufactured using state-of-the-art technology. All components are subject to stringent quality and environmental criteria during production. Our management systems are certified in accordance with ISO 9001 and ISO 14001.
- These operating instructions contain important information on handling the instrument. Working safely requires that all safety instructions and work instructions are observed.
- Observe the relevant local accident prevention regulations and general safety regulations for the instrument's range of use.
- The operating instructions are part of the product and must be kept in the immediate vicinity of the instrument and readily accessible to skilled personnel at any time. Pass the operating instructions on to the next operator or owner of the instrument.
- Skilled personnel must have carefully read and understood the operating instructions prior to beginning any work.
- In case of a different interpretation of the translated and the English operating instructions, the English wording shall prevail.
- If available, the provided supplier documentation is also considered to be part of the product in addition to these operating instructions.
- The general terms and conditions contained in the sales documentation shall apply.
- Subject to technical modifications.
- Factory calibrations / DAkkS calibrations are carried out in accordance with international standards.

Further information:

Mensor Corporation

- Address: 201 Barnes Drive
San Marcos, TX 78666
- Internet address: www.mensor.com
- Relevant data sheet: CT 28.01
- Contact: Tel.: 1-512-396-4200
1-800-984-4200 (USA only)
sales@mensor.com
techservices@mensor.com

Importer for Europe

WIKA Alexander Wiegand SE & Co. KG

- Address: Alexander-Wiegand-Straße 30
D-63911 Klingenberg / Germany
- Internet address: www.wika.de / www.wika.com
- Relevant data sheet: CT 27.62
- Contact: Tel.: +49 93 72/132-5015
CTsales@wika.com

1. General information

1.1 Software licence agreement

This product contains software programs, that are licenced for use by the end user/customer (hereinafter “end user”). It is prohibited to modify, translate, reverse engineer, decompile, disassemble or decode the software programs in whole or in part, or to create works derived from the program.

EN



The software programs are provided “as is” without any warranty of any kind. The entire risk of the quality and performance of the software program is with the end user.

1.2 Abbreviations, definitions

- Bullet
- ▶ Instruction
- 1. ... x. Follow the instruction step by step
- ⇒ Result of an instruction
- See ... cross-references

1.3 Explanation of symbols



DANGER!

... indicates a directly dangerous situation resulting in serious injury or death, if not avoided.



WARNING!

... indicates a potentially dangerous situation that can result in serious injury or death, if not avoided.



CAUTION!

... indicates a potentially dangerous situation that can result in light injuries or damage to property or the environment, if not avoided.



DANGER!

... identifies hazards caused by electrical power. Should the safety instructions not be observed, there is a risk of serious or fatal injury.



Information

... points out useful tips, recommendations and information for efficient and trouble-free operation.

2. Safety

2. Safety

2.1 Intended use

The CPC8000 is designed to automate the testing and calibration of all types of pressure instruments and other instruments. Up to three removable/interchangeable pressure transducers are available in full scale (FS) ranges from -1 ... 400 bar [5 ... 6,000 psig or 7.5 ... 6,015 psia]. Each transducer module is configured with its own calibration parameters on board and has 0.01% FS up to 0.008 % IS-33 accuracy.

The three transducers, in combination with the internal control valve regulator, provide a dynamic output. The operator can choose to control pressure either using a single, selected transducer or auto-range control across all three transducers. The ratio between the highest FS range and the lowest FS range within the CPC8000 cannot exceed 10:1. The three ranges can be chosen to optimise accuracy levels across the full pressure span of the instrument.

In addition to the capacity for three active ranges, a fourth, barometric transducer is available. With a barometric transducer, a CPC8000, with absolute or gauge transducers, can emulate pressure of the opposite type.

The CPC8000 can be supplied with standard 0.01 % IS-50 transducers up to 0.008 % IS-33 transducers to give a percent of reading accuracy down to 50 % or 33 % of full scale respectively.

→ Refer to chapter 12 “Specifications”, for a full description of the accuracy specification and chapter 4.8 “IntelliScale”.



WARNING!

Not explosion-protected

This instrument must not be installed and used in areas where explosive atmospheres may potentially be present.

The instrument has been designed and engineered solely for the intended use described here, and may only be used accordingly.

The technical specifications in these operating instructions must be observed, see chapter 12 “Specifications”. It is assumed that the instrument is handled properly and within its technical specifications. Otherwise, the instrument must be taken out of service immediately and inspected by an authorised WIKA service engineer.

Handle electronic precision measuring instruments with the required care (protect from humidity, impacts, strong magnetic fields, static electricity and extreme temperatures, do not insert any objects into the instrument or its openings). Connectors and female connectors must be protected from contamination.

The manufacturer shall not be liable for claims of any type based on operation contrary to the intended use.

2.1.1 Radio frequency emission notices



WARNING!

Use shielded cables to connect external instruments to this instrument to minimise HF radiation.



Note for instruments with EMC and class A

This is class A equipment for emitted interference and is intended for use in industrial environments. In other environments, e.g. residential or commercial installations, it can interfere with other equipment under certain conditions. In such circumstances the operator is expected to take the appropriate measures.

2. Safety

2.1.2 FCC emission notice

This equipment has been tested and found to comply with the limits for a class A digital instrument, pursuant to part 15 of the FCC rules. These limits are designed to provide reasonable protection against harmful interference when the equipment is operated in a commercial environment. This equipment generates, uses, and can radiate radio frequency energy and, if not installed and used in accordance with the operating instructions, may cause harmful interference to radio communications. Operation of this equipment in a residential area is likely to cause harmful interference in which case the user will be required to correct the interference at his or her own expense.

2.2 Improper use

- Avoid improper transport and storage.
- Avoid incorrect installation, mounting, operation and maintenance.
- Avoid incorrect handling of pressure connections and the use of hazardous or toxic media.
- Do not insert any objects into the controller.
- Refrain from unauthorised modifications to the instrument.
- Do not use this instrument in safety or emergency shutdown devices.

Any use beyond or different to the intended use is considered as improper use.

2.3 Personnel qualification



The activities described in these operating instructions may only be carried out by skilled personnel who have the qualifications described below.

Skilled personnel

Skilled personnel, authorised by the operator, are understood to be personnel who, based on their technical training, knowledge of measurement and control technology and on their experience and knowledge of country-specific regulations, current standards and directives, are capable of carrying out the work described and independently recognising potential hazards.

Special operating conditions require further appropriate knowledge, e.g. of hazardous media.

2.4 Personal protective equipment

The personal protective equipment is designed to protect the skilled personnel from hazards that could impair their safety or health during work. When carrying out the various tasks on and with the instrument, the skilled personnel must wear personal protective equipment.

When using the instrument, it is recommended to wear the following protective equipment.



Wear ear defenders

Protect ears from noise.

Ear defenders are required in case other appropriate measures cannot prevent the personnel from being put at risk.

2. Safety

2.5 Labelling, safety markings

The labelling, safety markings must be maintained in a legible condition.

Product label (example)

The product label is attached to the rear.

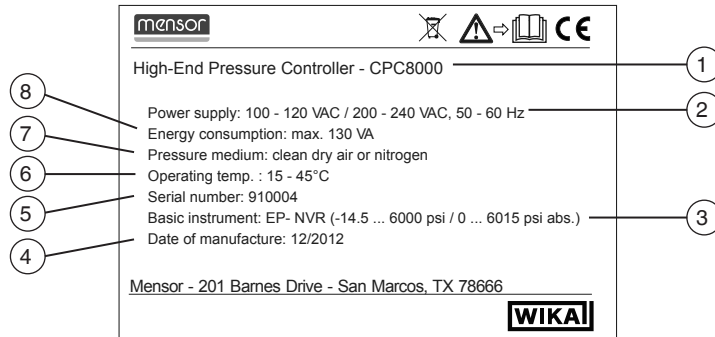

- ① Product name
- ② Auxiliary power
- ③ Control ranges
- ④ Date of manufacture (MM/YYYY)
- ⑤ Serial number
- ⑥ Permissible ambient temperature
- ⑦ Pressure transmission medium
- ⑧ Power consumption

Symbols



Before mounting and commissioning the instrument, ensure you read the operating instructions.



Do not dispose of with household waste. Ensure a proper disposal in accordance with national regulations.

3. Transport, packaging and storage

3. Transport, packaging and storage

3.1 Transport

EN



CAUTION!

Damage through improper transport

With improper transport, damage to property can occur.

- ▶ When unloading packed goods upon delivery as well as during internal transport, proceed carefully and observe the symbols on the packaging.
- ▶ With internal transport, observe the instructions in chapter 3.2 “Packaging and storage”.

Check the instrument for any damage that may have been caused.

In the event of any damage, do not commission the instrument and contact the manufacturer immediately.

If the instrument is transported from a cold into a warm environment, the formation of condensation may result in instrument malfunction. Prior to recommissioning, wait for the instrument temperature and the room temperature to equalise.

3.2 Packaging and storage

Do not remove packaging until just before mounting or operation.

Keep the packaging as it will provide optimum protection during transport (e.g. change in place of use, sending for repair).

Permissible conditions at the place of storage:

- Storage temperature: 0 ... 70 °C [32 ... 158 °F]
- Humidity: 0 ... 85 % relative humidity (non-condensing)

Avoid exposure to the following factors:

- Direct sunlight or proximity to hot objects
- Mechanical vibration, mechanical shock (putting it down hard)
- Soot, vapour, dust and corrosive gases
- Hazardous environments, flammable atmospheres

Store the instrument in its original packaging in a location that fulfils the previously listed conditions. Instruments that have already been commissioned must be cleaned before storage, see chapter 10.2 “Cleaning”.

If the original packaging is not available, pack and store the instrument as described below:

1. Wrap the instrument in an anti-static plastic film.
2. Place the instrument, along with the shock-absorbent material, in the packaging.
3. If stored for a prolonged period of time (more than 30 days), place a bag containing a desiccant inside the packaging.

4. Design and function

4. Design and function

4.1 Overview



- ① Screws for opening/closing the front panel
- ② Hinged display panel
- ③ Label with information on the measuring ranges
- ④ USB port
- ⑤ Power switch

4.2 Scope of delivery

- Pressure controller, high-end version, model CPC8000
- Power cord 2 m [6.5 ft]
- Operating instructions
- Quick start guide
- Calibration certificate
- Ordered accessories
- 2 manifold seal plates (either attached internally or sent externally with the CPC8000)
- 3/16" Allen key
- Microfibre cloth to clean the glass front panel
- Silencer, if pressure ranges ≥ 70 bar [$\geq 1,000$ psi]

Cross-check scope of delivery with delivery note.

4.3 Description

The model CPC8000 pressure controller, high-end version is the highest performance pressure controller and features the following:

- 19" rack mount compatibility
- A large 9" LC colour display with glass capacitive touchscreen for intuitive operator interface.
- Front panel door gives access to instrument interior.
- Pressure ranges from -1 ... 400 bar [5 ... 6,000 psi]; up to 10:1 turndown
- Up to three highly stable and removable/interchangeable pressure transducers with an accuracy of up to 0.008 % IS-33 (IntelliScale-33), see chapter 5.4 "Replacing or removing the pressure transducers". Each transducer is a totally self-contained module including its unique calibration data.
- IntelliScale calibrations for maximum accuracy specifications
- A barometric reference as a high-performance barometer module can be used for accurate emulation of gauge pressure with absolute pressure instruments, or used for absolute pressure emulation with gauge pressure instruments.

4. Design and function

- A very quiet precision pressure controller with a fast response time.
- Adaptive control algorithm with rate control capability
- Ethernet, RS-232, USB, and IEEE-488 communications
- Remote compatibility with PCS400, CPC6000, CPC3000, old CPC8000 (SCPI)
- Emulation of competitive instrument command sets
- Local program capability
- Multiple languages are supported; simply touch one of the national flags on the display to instantly change the on-screen text language, and the corresponding number and date formats. For more detailed information, see chapter 7.1.1 “Language”.
- Onboard diagnostic logging
- Designed for serviceability and reliability
- Complies with latest CE and 61010 regulations

4.4 Front panel

The front of the CPC8000 has a smooth, uncluttered appearance. Its main feature is the large colour display plus an identification label in the lower right corner of the display panel. The display panel is hinged for easy access to remove or replace the transducer modules inside. The instructions for accessing the transducers are provided in chapter 5.4 “Replacing or removing the pressure transducers”. Immediately to the right of the display panel is a USB port and a power switch.

4.4.1 Power switch

The power switch is a two-state instrument with an action similar to that of a ball point pen. Push the button with enough force to latch it in to turn the unit ON. Push it again to release it to turn the system OFF.



If the power supply is interrupted during operation and then restored shortly afterwards, the instrument automatically switches back on in vented mode.

4.4.2 USB port

The front panel USB port is the same as the host USB port on the rear panel. Both are intended for future expansions or software upgrades

4.4.3 Information label

The front panel label identifies the instrument name, installed transducer ranges in the pressure units specified by the customer, and the serial number.

4.4.4 Screen

The large 9" LC colour display has a glass capacitive touchscreen for navigation within the intuitive operator interface. At power up the main screen is presented.

The calibration of the pressure monitoring and testing functions can be performed via the touchscreen. The majority of operations will be carried out via this screen.

A overview of the individual features on the various displays is included in chapter 6 “Operation via menu functions”.

4. Design and function

4.5 Reference pressure transducers



CAUTION!

When replacing transducers the order of position **MUST** be maintained according to the pressure limit of each transducer. Starting with the highest pressure transducer on the left (primary transducer), and the next lower pressure limit transducer next (secondary transducer), and the low ranged transducer at the far right (tertiary transducer). If the system will be operated with less than the full complement of three pressure transducers, any empty slots must begin at the far right where the tertiary transducer is normally located.

EN

The manifold seal is a metal plate used to seal the pneumatic openings on the manifold at an unused transducer slot. If there is just a single pressure transducer installed then two manifold seals are installed. All transducer slots must be sealed with either transducers or seal plates for the instrument to function. Two manifold seal plates are shipped with each unit for this purpose.

The D-Sub connectors for unused slots can remain unplugged.

Up to three transducers can be present within the CPC8000. The full scale pressure of the highest ranged transducer (primary transducer) must fall within the range of the installed regulator module, see table in chapter 4.6 "Regulator ranges".

This primary transducer occupies the leftmost slot within the CPC8000. The other two slots can be empty or occupied with lower ranged transducers but their full scale range cannot exceed a ratio of 10:1 of the primary transducer. In other words, the lowest full scale range in the CPC8000 cannot be less than one tenth of the range of the primary transducer full scale range, see chapter 4.7 "Transducer selection".



- ① Primary transducer
- ② Secondary transducer
- ③ Tertiary transducer

4. Design and function

4.6 Regulator ranges

The CPC8000 is supplied with one of five different needle valve regulators (NVR). The table shows each regulator and its corresponding pressure range limits.

EN

- LP = Low pressure
- MP = Medium pressure
- SP = Standard pressure
- HP = High pressure
- EP = Extended pressure
- NVR = Needle valve regulator

Regulator module	Primary range limits	
Pressure range	Gauge	Absolute
LP-NVR	≤ 6 bar [≤ 90 psi]	≤ 7 bar abs. [≤ 105 psi abs.]
MP-NVR	<ul style="list-style-type: none"> ■ > 6 bar [> 90 psi] ■ ≤ 70 bar [≤ 1,000 psi] 	<ul style="list-style-type: none"> ■ > 7 bar abs. [> 105 psi abs.] ■ ≤ 71 bar abs. [1,015 psi abs.]
SP-NVR	<ul style="list-style-type: none"> ■ > 70 bar [> 1,000 psi] ■ ≤ 135 bar [≤ 2,000 psi] 	<ul style="list-style-type: none"> ■ > 71 bar abs. [> 1,015 psi abs.] ■ ≤ 136 bar abs. [≤ 2,015 psi abs.]
HP-NVR	<ul style="list-style-type: none"> ■ > 135 bar [> 2,000 psi] ■ ≤ 210 bar [≤ 3,000 psi] 	<ul style="list-style-type: none"> ■ > 136 bar abs. [> 2,015 psi abs.] ■ ≤ 211 bar abs. [≤ 3,015 psi abs.]
EP-NVR	<ul style="list-style-type: none"> ■ > 210 bar [> 3,000 psi] ■ ≤ 400 bar [≤ 6,000 psi] 	<ul style="list-style-type: none"> ■ > 211 bar abs. [> 3,015 psi abs.] ■ ≤ 401 bar abs. [≤ 6,015 psi abs.]

Fig. 4.6-A – Table of the primary transducer limit for each regulator

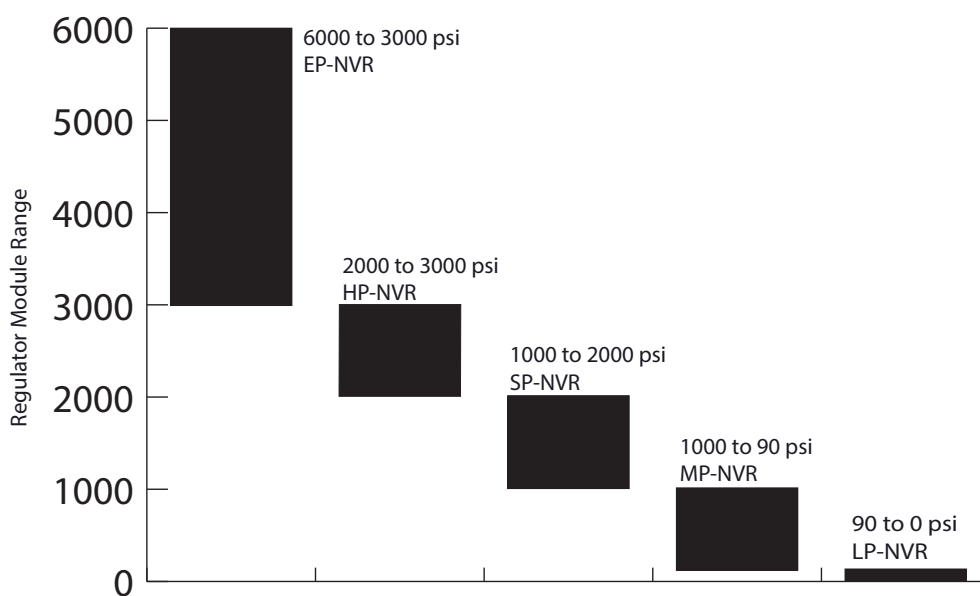

Fig. 4.6-B – Graphical representation of the primary transducer limit for each regulator

The primary transducer (transducer 1) full scale range must fall within one of the regulator range limits shown in fig. 4.6-A or fig. 4.6-B. The secondary and tertiary transducers may fall outside of these limits but must not have a full scale value less than 1/10 of the primary transducer full scale range.

4. Design and function

4.7 Transducer selection

Transducer measuring modes can be gauge, absolute, or bidirectional. The CPC8000 will be equipped with one, two or three transducers of the same mode. The three transducers, in combination with NVR module, provide a wide dynamic range (10:1 FS) where the operator can choose to control output pressure using a single transducer, or auto-range control across all three transducers. The three transducer ranges can be chosen to optimise accuracy levels. Full scale transducer ranges up to 400 bar [6,000 psi] are available plus an optional barometric transducer. The accuracy specifications, plus a proprietary needle valve regulator, provides accurate and stable control.

The number of unique readings/s over the remote interface is dependent on the transducer type. The refresh rate of the transducers in the CPR8000 is 30 ms or 33 unique readings/s. All remote protocols can query faster than the refresh rate of the sensors. An optional precision barometer module can be used for emulation of gauge pressure with an absolute pressure instrument, or used for absolute pressure emulation with a gauge pressure instrument. For full range absolute emulation, the instrument gauge transducers should be ranged down to -1 bar [-15 psi].

Transducer model CPR8000	Primary transducer	Secondary transducer	Tertiary transducer
Accuracy			
Standard	■ 0.01 % FS ■ 0.01 % IS-50	■ 0.01 % FS ■ 0.01 % IS-50	■ 0.01 % FS ■ 0.01 % IS-50
Premium	■ 0.008 % FS ■ 0.008 % IS-50 ■ 0.008 % IS-33	■ 0.008 % FS ■ 0.008 % IS-50 ■ 0.008 % IS-33	■ 0.008 % FS ■ 0.008 % IS-50 ■ 0.008 % IS-33

4.8 IntelliScale

IntelliScale is a calibration technique that provides another degree of certainty to a pressure measurement specification. Or said another way, IntelliScale is designed to further reduce the accuracy specification. It does this by considering the full pressure range as two separate ranges; a specifically defined lower range, and the remaining upper range. It then defines the accuracy of the lower portion as a percent of the full scale of that lower range, and the accuracy of the upper portion as a percent of reading at any pressure point within that upper range.

4.8.1 IntelliScale 0.01 % IS-50

In practice, the standard Mensor IntelliScale specification is 0.01 % IS-50. This means that the full scale lower half (50 % of the total range) has an accuracy of 0.01 % of that portion of the range, while the upper half of the total range has an accuracy of 0.01 % of the pressure reading. Thus, any pressure within the lower half of the pressure range has a fixed number for the accuracy (0.01 % of that half scale), while the accuracy anywhere in the upper half of the full range is a sliding scale number; that is, a percent (0.01 %) of any reading.

For example:

An instrument with a pressure range from 0 ... 6.8 bar [0 ... 100 psi] with an accuracy specification of IntelliScale 0.01 % IS-50 will have an accuracy of 0.005 psi (0.01 % x 3.4 bar [50 psi] FS) on any pressure from 0 to 3.4 bar [0 to 50 psi], and an accuracy of 0.01 % of reading (0.01 % x R) for any pressure above 3.4 bar [50 psi].

→ See Fig "4.7.1-A – IntelliScale IS-50".

4.8.2 IntelliScale 0.008 % IS-33, optional

An option available for some ranges is IntelliScale 0.008 % IS-33, where the lower portion of the full scale range is 33 % of the total range, and the upper portion of the full scale range is 67 % of the full range. The result is an accuracy of 0.00264 % (0.008 % x 33 % FS) of the total full scale pressure for the one third low end range, and an accuracy of 0.008 % of reading (0.008 % x R) for any pressure in the upper two thirds of the transducer range.

→ See Fig "4.7.1-B – IntelliScale IS-33".

4. Design and function

EN

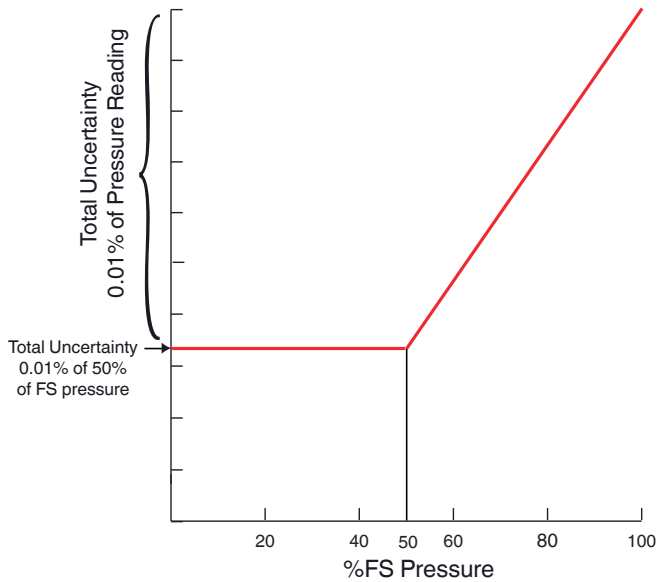

Fig. 4.7.1-A – IntelliScale IS-50

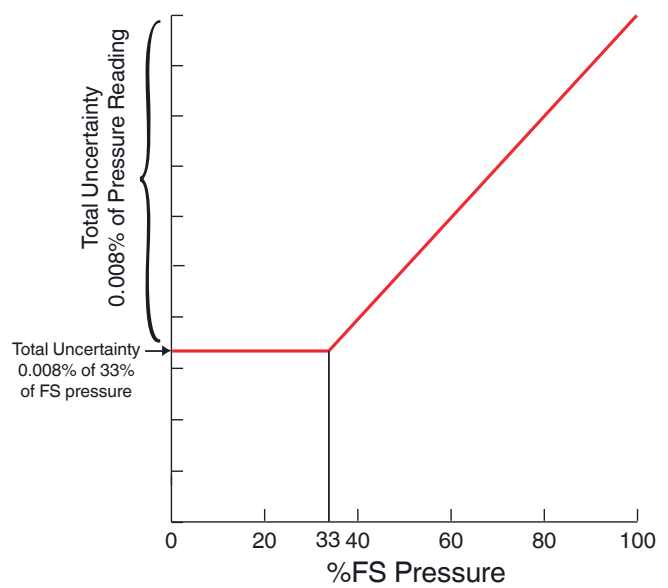

Fig. 4.7.1-B – IntelliScale IS-33

4.9 Accessories

4.9.1 Transport case

The transport case with wheels enables the CPC8000 to be transported between different points of use, or it can be used as a container for air freight (or other transport) and provides complete and long-term protection against rough handling.

The case is constructed of a high-impact plastic with a black exterior. It includes two keys, locks, a piano hinge, an anodised interlocking tongue and groove opening, various nickel-chrome and stainless steel fixtures, a vinyl satchel style handle and a retractable pull-out handle. The interior is filled with high-density polyurethane foam with a die-cut cavity to cradle the instrument with fitting adapters in place, and an additional cavity to store related accessories. Rugged and weather resistant, the case makes an attractive, practical shipping and moving container.

The case weighs approximately 13.15 kg [29 pounds] unloaded. It can support a load of up to 68.04 kg [150 pounds]. Nominal dimensions are 38.10 x 60.96 x 66.04 cm [15 x 24 x 26 in].

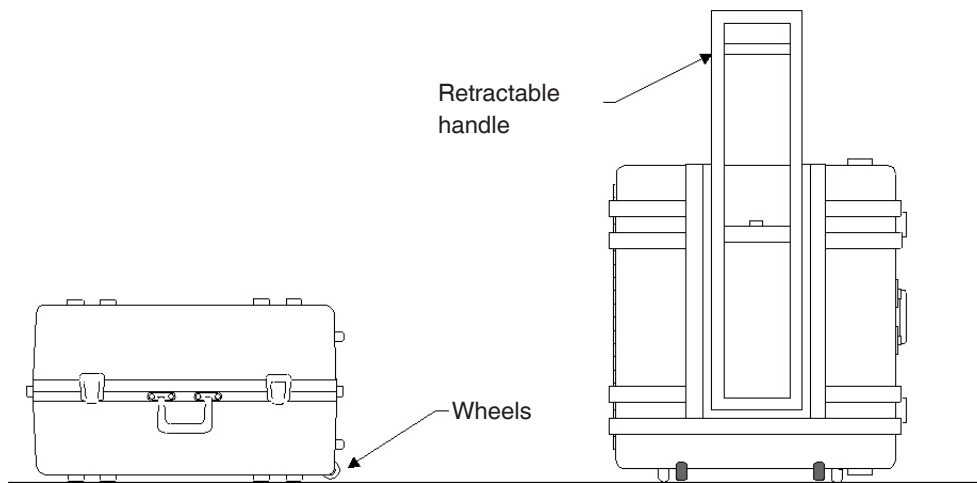

4. Design and function

4.9.2 Rack-mounting kit

A CPC8000 can be installed in a standard 19" rack using the rack-mounting kit.

4.9.3 Barometric reference transducer

This optional transducer allows gauge mode instruments to operate in absolute mode, and similarly, absolute mode instruments to operate in gauge mode. Changing modes is easily accomplished from the front panel or over the remote interface.

When used, the active channel of the CPC8000 will either add or subtract the measurement of the installed barometric reference transducer to accomplish the appropriate emulation.

4.9.4 Pressure booster

To control pressure, the CPC8000 requires a pressure supply of 10 % above the full scale of the instrument.

For ranges of 206.84 bar [3,000 psi] or greater, this is above the typical gas bottle / cylinder.

The model CPK-PS400 high-pressure compressor station is capable of compressing the cylinder pressure to the required supply pressure for all possible versions of the CPC8000 range while maximising cylinder/gas cylinder utilisation.

The pressure supply package CPK-PS400 is a total package ready-to-connect (plug-and-play) for providing pressure. The compressor station allows you to generate working and test pressures of up to 400 bar [6,000 psi] from an initial pressure of 7 ... 15 bar [102 ... 218 psi] (e.g. from a nitrogen cylinder) by means of an air drive pressure of 1 ... 6.5 bar [14.5 ... 95 psi].

Specifications	High-pressure compressor station
Pressure range	0 ... 400 bar [0 ... 6,000 psi]
Compressed-air drive	Minimum: 1 bar [14.5 psi] Maximum: 6.5 bar [95 psi]
Initial pressure (test air)	7 ... 15 bar [102 ... 218 psi]
Operating medium	Nitrogen
Transmission ratio	1 : 15 / 1 : 75
Sound emission	79 dB (A)
Storage volume	Approx. 0.2 l (tubular accumulator)
Connection (air drive pressure)	G ½ female with adapter on 6 mm Swagelok® tube fitting
Connection (test air)	G ¼ female with adapter on 6 mm Swagelok® tube fitting
Connection (pressure outlet)	9/16-18 UNF with adapter on 6 mm Swagelok® tube fitting
Dimensions in L x W x H	940 x 420 x 520 mm [37 x 16.5 x 20.5 in]
Weight	51 kg [136.6 lb]
Features	No electrical energy required, equipped with a pressure reducer and a 10 µm filter

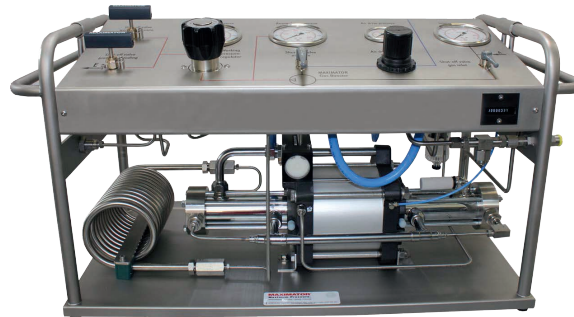

Fig. 4.9.4 – High-pressure compressor station model CPK-PS400

5. Commissioning and operation

5. Commissioning and operation

Personnel: skilled personnel

Protective equipment: ear defenders

Tools: spanner

EN



CAUTION!

Damage to property due to electrostatic discharge (ESD)

When working on open circuits (PCBs) there is a danger of damaging sensitive electronic components through electrostatic discharge.

- ▶ The correct use of grounded working surfaces and personal armbands is required.
- ▶ Do not touch PCBs and electrical components.
- ▶ Before removing the instrument cover, touch any part of the grounded metal case or an adjacent grounded metal object (e.g. radiator, pipelines) (static charges are dissipated from the body).
- ▶ Avoid contact between the electronics and clothing.



DANGER!

Danger to life due to electrical voltage

Upon contact with live parts, there is a direct danger to life.

- ▶ The instrument may only be installed and mounted by skilled personnel.
- ▶ Disconnect the instrument from the mains supply when it won't be used for a longer period of time.



A quick start guide has been placed inside the shipping box containing your instrument. This guide provides a quick reference to the pneumatic and electrical connections and an introduction to the operator interface. It is intended for experienced operators. All safety precautions within this manual should be understood and followed.

Only use original parts, see chapter 13 "Accessories and spare parts".

5.1 Unpacking the instrument

The CPC8000 was subjected to many hours of functional testing. In addition to testing, it was inspected for appearance prior to being packaged for shipment.

Check the instrument for any damage that may have been caused.

In the event of any damage, do not commission the instrument and contact the manufacturer immediately.

5.2 Requirements for the installation location

The installation location must meet the following conditions:

- Ambient temperature: compensated temperature range 15 ... 45 °C [59 ... 113 °F]
- Humidity: 0 ... 95 % relative humidity, non-condensing
- Flat, horizontal location; secure fixed working surface (desktop instrument) or proper installation in a sturdy 19" mounting rack or cabinet
- Sufficient air circulation must be provided at the rear of the instrument to avoid accumulation of heat
- Pressure supply requirements:
- Stable supply pressure 10 % higher than the full scale of the controller
- Permissible media: dry, clean air or nitrogen
- Vacuum: minimum 50 litres per minute (if required)

→ For further specifications, see also chapter 12 "Specifications":

5. Commissioning and operation

5.3 Connecting the instrument

5.3.1 Pressure connections



WARNING!

High pressure

High-pressure gases are potentially hazardous. Energy stored in these gases and liquids can be released suddenly and with extreme force.

- ▶ High-pressure systems should be assembled and operated only by personnel who have been trained in proper safety practices.



WARNING!

Possible injury

The tubing, valves and other apparatus attached to the instrument must be adequate for the maximum pressure which will be applied, otherwise physical injury to the operator or bystanders is possible.

- ▶ Install the pressure connections according to the following instructions, observing the relevant regulations.
- ▶ The installation is to be performed by trained, authorised personnel, knowledgeable in the safety regulations for working on pneumatic/hydraulic systems.



CAUTION!

Wrong pressure transmission medium

- ▶ Always use the correct pressure transmission medium.
- ▶ Use only clean, dry, non-corrosive gases.
- ▶ This instrument is not designed for oxygen use.



Up to 6 pressure connections are on the rear panel. Pressure connections that are not assigned are plugged.

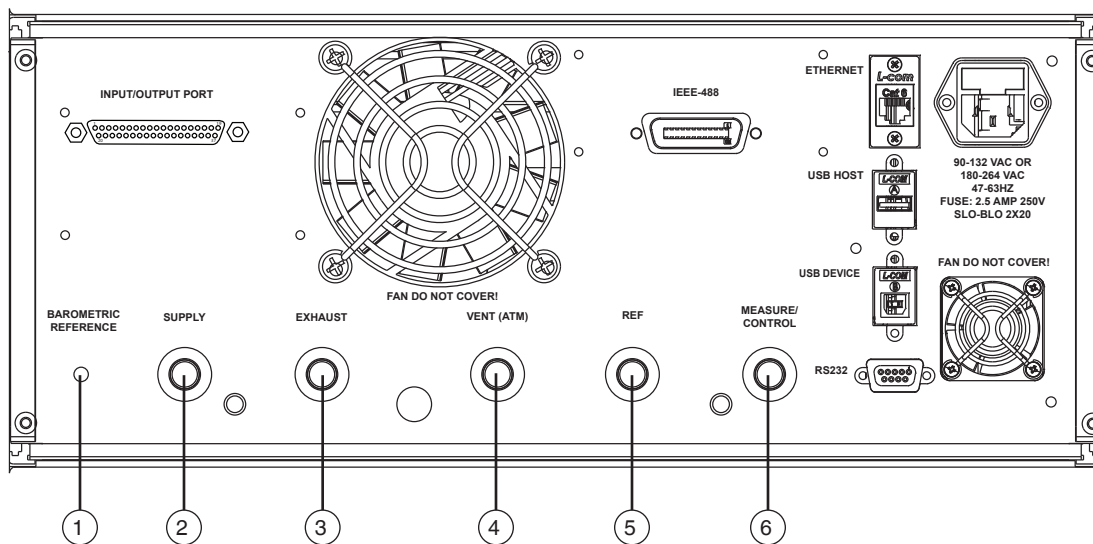



Fig. 5.3.1 – Pressure connections

Pos.	Label	Description
1	BAROMETRIC REFERENCE	Barometric reference The barometric reference port is connected to the internal barometric transducer and should be left open to atmospheric pressure.

5. Commissioning and operation

EN

Pos.	Label	Description
②	SUPPLY	<p>Supply port</p> <p>The pressure supplied to the pressure connection labelled “Supply” should be approximately 10 % higher than the full scale value of the highest-ranged pressure transducer installed in the controller. → See the product label at the bottom right of the front panel.</p>
③	EXHAUST	<p>Exhaust port</p> <p>The pressure connection labelled “Exhaust” is for the vacuum supply. In a gauge pressure version it can be left open to atmospheric pressure. If the instrument’s primary transducer pressure range has the minimum pressure in the vacuum region but is not negative atmosphere, a vacuum regulator will be included. The vacuum regulator included will need to be connected in-line between a vacuum pump and the exhaust port of the instrument in order for the instrument to control properly. This vacuum regulator will need to be set to 10 % below the minimum range of the primary transducer of the instrument. The vacuum regulator can be set using a slotted screwdriver.</p>
④	VENT (ATM)	<p>Vent port</p> <p>The pressure connection labelled “Vent” is the exhaust port where the system pressure is vented to the atmosphere under certain conditions. Leave this port open or connect the optional silencer for noise reduction.</p>
⑤	REF	<p>Reference port</p> <p>Pressure connection to the reference ports of transducers with ranges < 4 bar [< 50 psi] gauge.</p> <div style="display: flex; align-items: center; margin-top: 10px;">  <p>The reference port should be left open to the atmosphere and should NEVER be connected to a pressure source.</p> </div> <p>The higher the supply pressure connected to the supply port, the higher the pressure which leaves the system through the exhaust port. If a vacuum pump is connected to the exhaust port, adequate safety precautions have to be taken to prevent damage to the pump. If vacuum is connected to the exhaust port of the controller, negative pressure peaks might occur at the Measure/Control port for a very short time, when changing from the measure mode to the control mode. Before the system is connected, the user must ensure that suitable protection measures are in place which exclude overpressuring of the test piece or the system.</p>
⑥	MEASURE/ CONTROL	<p>Measure/Control port</p> <p>The Measure/Control port (when in the control mode) supplies pressure that is precisely controlled by the controller. In the measure mode a pressure applied to the Measure/Control port is measured by the instrument transducer.</p>

5.3.2 Pneumatic connections and pressure fittings

The CPC8000 is supplied with five 1/4" tube OD x 7/16-20 male SAE/MS straight thread adapters or five 6 mm tube OD x 7/16-20 male SAE/MS straight thread adaptors (per order). The 7/16-20 male SAE/MS straight thread end of the adapters should be connected to the instrument’s 7/16-20 female SAE/MS straight thread connections. The adapters need only be wrench-tight for proper sealing. Connections should be made according to your specific requirements (for example, a vacuum pump is only required when controlling to a subatmospheric pressure).



WARNING!

The user must ensure that released pressure medium does not endanger personnel, environment or the instrument.



NOTE

For functional testing and to become familiar with the operation of the CPC8000, a volume close to the volume expected during normal operation can be connected to the Measure/Control port.

5. Commissioning and operation



NOTE

Test items with large volumes or long piping runs with small diameter tubing can have a negative effect on the control performance.

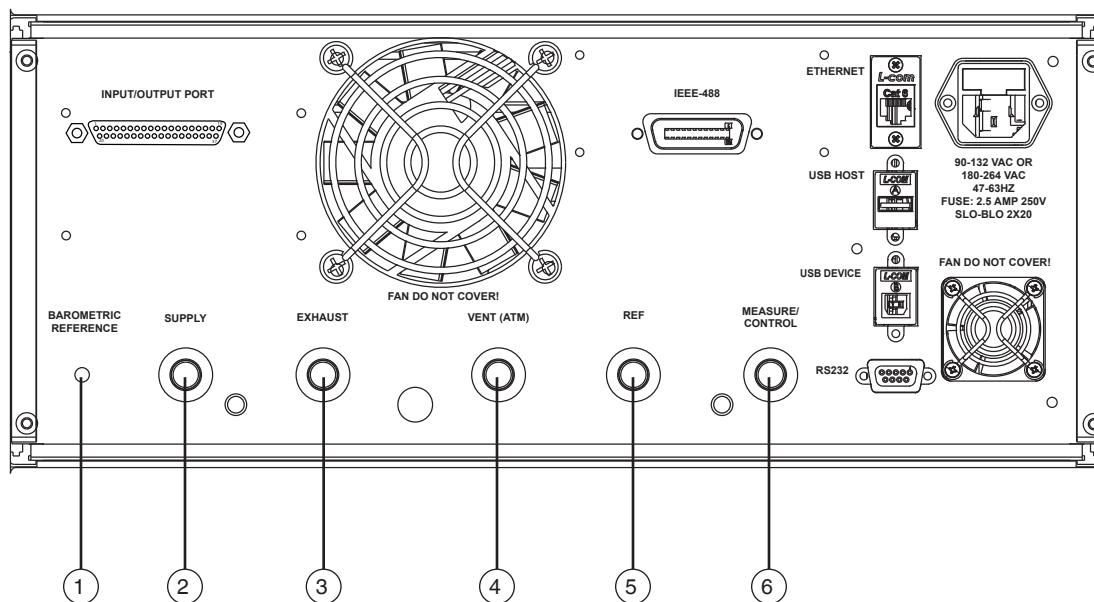

Fig. 5.3.2 – Pneumatic setup

Pos.	Label	Pressure connection	Connection
①	BAROMETRIC REFERENCE		Open
②	SUPPLY	7/16-20 UNF	Clean dry air or nitrogen-regulated pneumatic supply pressure set at 110 % of the highest full scale internal range
③	EXHAUST	7/16-20 UNF	Vacuum pump, if required for sub-atmospheric pressure, otherwise open
④	VENT (ATM)	7/16-20 UNF	Open or silencer
⑤	REF	7/16-20 UNF	Open
⑥	MEASURE/CONTROL	7/16-20 UNF	Device under test

5. Commissioning and operation

5.3.3 Electrical connections and interfaces



WARNING!

The electrical installation must be done according to the following instructions while observing the relevant regulations.

- It is to be performed by individuals familiar with the safety regulations for working on electrical connections.

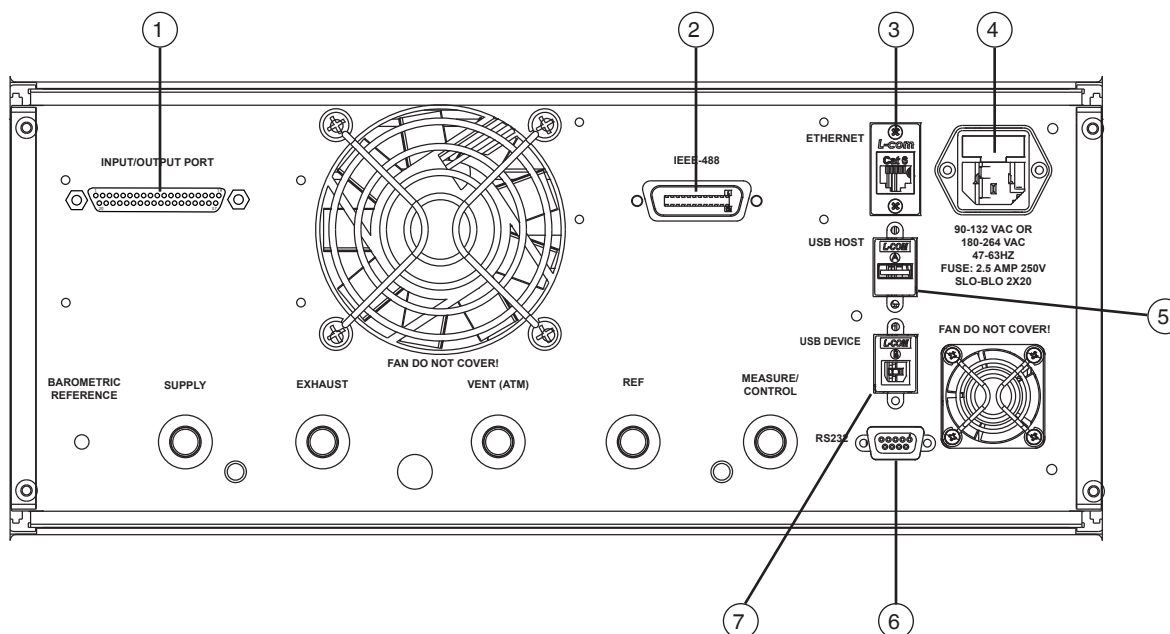

Fig. 5.3.3 – Electrical connections

Pos.	Label	Connection
①	INPUT/OUTPUT PORT	<p>Input/output port</p> <p>CAUTION! The Input/Output port has eight digital inputs that will accept either DC 3.3 V or DC 5 V signalling. Each input consumes about 8 ... 10 mA. If a voltage greater than DC 6 V is applied to an input it will be permanently damaged.</p> <p>The input/output port also has eight relay outputs. Both normally open and normally closed contacts are available for each output on the port. The contact ratings for the relays are as follows:</p> <ul style="list-style-type: none"> ■ Rated load (resistive): 0.5 A at AC 125 V, 1 A at DC 24 V ■ Rated carry current: 2 A ■ Max. switching voltage: AC 125 V, DC 60 V ■ Max. switching current: 1 A ■ Max. switching power: 62.5 VA, 30 W <p>The instrument can be set to respond to the digital inputs and to change the outputs based on certain conditions, see chapter 7.5.5 "Digital I/O".</p>
②	IEEE-488	The IEEE-488 interface is used for remote communication.
③	ETHERNET	The Ethernet jack is a standard Ethernet interface used for remote communication.
④	90-132 VAC OR 180-264 AC 47-63HZ FUSE: 2.5 AMP 250 V SLO-BLO 5X20	<p>Power supply</p> <ul style="list-style-type: none"> ■ Auxiliary power AC 90 ... 132 V or AC 180 ... 264 V / 47 ... 63 Hz ■ Microfuse 2.5 AMP 250 V / SLO-BLO 5X20

5. Commissioning and operation

Pos.	Label	Connection
5	USB HOST	USB interface (host) for service The USB host interface is a service port used to upgrade software and download information from the instrument. It has the same function as the USB host port on the front of the CPC8000.
6	RS232	The RS-232 interface is a 9-pin D-Sub socket used for remote communication.
7	USB DEVICE	USB interface (instrument) for remote communication The USB device jack is a standard USB type B receptacle interface used for remote communication. → The USB driver can be downloaded on the website.

EN

5.3.4 Notices regarding the electrical connections

5.3.4.1 Power supply



DANGER!

Damage due to incorrect voltage supply

The instrument can be operated at different voltages. However, an incorrect voltage can damage it

- ▶ Switch off the instrument before connecting the new power supply.
- ▶ Before connecting the power supply, ensure that the correct voltage is applied to the CPC8000.

The operating voltage should be within this voltage range:

⇒ AC 90 ... 132 V or AC 180 ... 264 V / 47 ... 63 Hz

- ▶ Check the voltage supply against the specifications on the rear of the instrument.



WARNING!

Hazardous voltages

The system is powered via the power cord with a voltage that can cause physical injury. Even after disconnecting the system from auxiliary power, dangerous voltages can temporarily occur due to capacitance.



Do not use detachable power cord with inadequate ratings. For power supply ratings, see chapter 12 "Specifications".

The 3-pin power cord supplied is fitted with a ground lead. The system should only be operated from a 3-pin socket with the ground lead properly connected.

5.3.4.2 Interfaces



WARNING!

The interface cables must not be longer than 3 m [9.84 ft] and must be separate from cables with voltages greater than AC/DC 60 V.



NOTE

USB ports are compliant with the industry standard and are not listed here.

5. Commissioning and operation

5.3.4.2.1 Pin assignment of the RS-232 interface

9-pin D-Sub socket

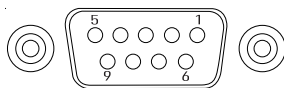

Pin	Description
1	DCD
2	TxD
3	RxD

Pin	Description
4	DTR
5	GND
6	DSR

Pin	Description
7	RTS
8	CTS
9	Ri

► No null modem required.

5.3.4.2.2 Pin assignment of the IEEE-488.2 interface

24-pin IEEE-488 socket

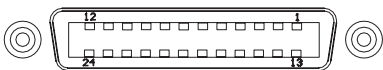

Pin	Description
1	D101
2	D102
3	D103
4	D104
5	EOI
6	DAV
7	NRFD
8	NDAC

Pin	Description
9	IFC
10	SRQ
11	ATN
12	SHIELD
13	D105
14	D106
15	D107
16	D108

Pin	Description
17	REN
18	GND
19	GND
20	GND
21	GND
22	GND
23	GND
24	GND

5.3.4.3 Input/output port



CAUTION!

The Input/Output port has eight digital inputs that will accept either DC 3.3 V or DC 5 V signalling. Each input consumes about 8 ... 10 mA. If a voltage greater than DC 6 V is applied to an input it will be permanently damaged.

Digital input/output

37-pin D-Sub socket

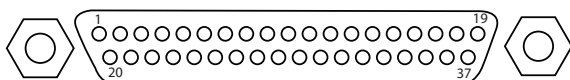

Pin	Description
1	GROUND
2	INPUT1
3	INPUT2
4	GROUND

Pin	Description
14	OUTPUT3-COM
15	OUTPUT3-NC
16	OUTPUT3-NO
17	OUTPUT4-COM

Pin	Description
27	OUTPUT5-NC
28	OUTPUT5-NO
29	OUTPUT6-COM
30	OUTPUT6-NC

5. Commissioning and operation

Pin	Description
5	INPUT3
6	INPUT4
7	GROUND
8	OUTPUT1-COM
9	OUTPUT1-NC
10	OUTPUT1-NO
11	OUTPUT2-COM
12	OUTPUT2-NC
13	OUTPUT2-NO

Pin	Description
18	OUTPUT4-NC
19	OUTPUT4-NO
20	INPUT5
21	INPUT6
22	GROUND
23	INPUT7
24	INPUT8
25	GROUND
26	OUTPUT5-COM

Pin	Description
31	OUTPUT6-NO
32	OUTPUT7-COM
33	OUTPUT7-NC
34	OUTPUT7-NO
35	OUTPUT8-COM
36	OUTPUT8-NC
37	OUTPUT8-NO

EN

5.4 Replacing or removing the pressure transducers

The front panel is hinged to allow access to the self-contained pressure transducers.

1. To open the front panel, first switch off system power.
2. Then loosen the two screws near the right hand edge of the front panel.
3. The front panel can now be opened.
⇒ The transducers lined up inside are accessible.



Screws to loosen the front panel



CAUTION!

Further access to the interior of the instrument is NOT recommended. There are no user-serviceable plumbing or parts inside. In addition to the dangerous voltages present (line voltage), there are circuits sensitive to electrostatic discharge damage.



CAUTION!

ESD protection required

The proper use of grounded work surfaces and personal wrist straps are required when coming into contact with exposed circuits (printed circuit boards) to prevent static discharge damage to sensitive electronic components.



If the system has not been switched off, opening the front panel will trip an interlock to vent the system to atmosphere.

4. To remove the transducers from the instrument, disconnect the 9-pin D-Sub connector at the top.
⇒ Use the supplied 3/16" Allen key to loosen the two cap screws near the base of the transducer.
5. With both screws disengaged, slide the transducer toward the front opening to disconnect it from the manifold.
⇒ If an optional barometric transducer is present it will occupy a slot to the far right and will be secured in place with a thumb screw.
6. Loosen the thumb screw and lift the transducer up and over the retaining pin.
7. To reintegrate a module or a replacement module into the system, it must be pressed firmly into position so that the pneumatic parts are reconnected to the manifold.
8. Then tighten the two retaining screws

5. Commissioning and operation

9. Reconnect the communication / power supply via the D-Sub connector.
10. To replace the optional barometer, slide it back into place over the retaining pin and tighten the thumb screw.
11. Finally, reattach the front panel.
12. Check whether the instrument is ready for operation.

EN

In replacing transducer modules the order of position must be maintained according to the pressure limit of each module; starting with the highest pressure transducer on the left (PRIMARY TRANSDUCER), and the next lower pressure limit transducer next (SECONDARY TRANSDUCER), and the lowest ranged transducer to the right (TERTIARY TRANSDUCER). If an optional BAROMETRIC TRANSDUCER is present it will occupy a different type slot to the right of the TERTIARY TRANSDUCER.



Each pressure or barometer module is totally self-contained and including the pressure transducer and all of its calibration data.

If the system will be operated with less than the full complement of three pressure modules (not including the BAROMETRIC TRANSDUCER) the first empty slots must be the TERTIARY TRANSDUCER Slot. If there is just one installed transducer then the SECONDARY TRANSDUCER slot would also be empty. To be functional, each empty slot must have a pneumatic seal on the manifold. In this case a manifold seal plate is supplied and attached at the Mensor factory for this purpose. The D-Sub connectors for unused slots can remain unplugged.

5.4.1 Pressure transducer location

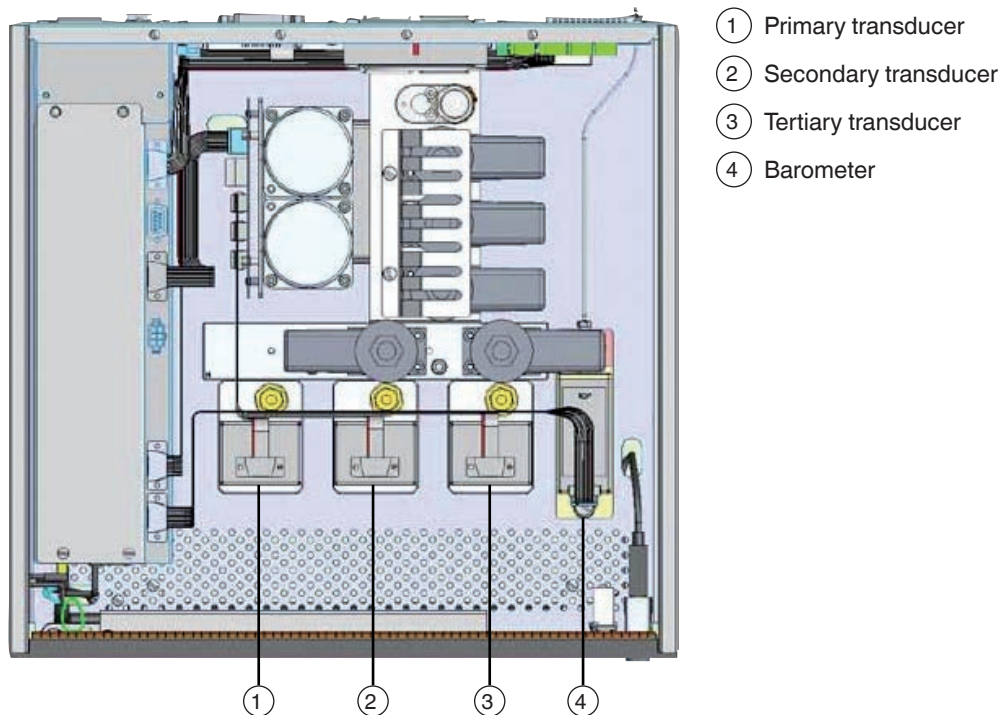

Fig. 4.5.2 – Top view

5. Commissioning and operation

5.4.2 Side panel removal

On desktop units the two identical side panels include formed recesses which are used as lift points to move or carry the instrument over short distances. These side panels are secured to the chassis by three 3 mm Allen cap screws accessible inside the lift-recesses.

- ▶ With the cap screws removed pull the side panel straight out away from the chassis with enough force to overcome the friction pins which hold it in position.

EN

5.5 Switching on the CPC8000

After the pressure connections are secure, apply power to the power connector on the rear of the instrument and switch the power switch ON. The instrument will go through an initialisation process and system check. As soon as the system check is completed the system will default to an operating screen similar to the screen shown in 6.1 “General information”.

Allow the instrument to warm up for at least 30 minutes before carrying out critical pressure measurements.



Earth ground!

Any power adapters or surge protection instruments that negate the protective earth ground should not be used. The power cord must be accessible and contain a protective earth ground.

Ventilation! Do not block airflow to ventilating fans located on rear of instrument.

The instrument can be set up on a table top or it can be rack mounted. Rack-mount adapters are optional.

After the controller has warmed up, cycle the pressure from the lower limit to the upper limit then back to the minimum pressure of the primary transducer with the desired volume connected to the Measure/Control port. This will allow the controller to properly compensate for the difference in external volume between what was used at the factory versus what is currently in use. This pressure cycle should occur after each power cycle, or when the external volume size has been changed.

6. Operation via menu functions

6. Operation via menu functions

Personnel: skilled personnel

Protective equipment: ear defenders

EN

6.1 General information

This chapter describes the procedures for operating the CPC8000 from the front cover. Instructions for operating the instrument from an external computer are covered in chapter 8 "Remote operation". By following the procedures provided in these two chapters and in chapter 7 "Basic settings", you can expect your CPC8000 to deliver maximum accuracy and dependability for many years of exceptional service.

6.2 Switching on

When the instrument is powered on it will take about 30 seconds to boot up. Once the start-up is complete, the main screen with numeric keypad appears in the right third of the display. The CPC8000 is now ready for operation.

To ensure rated accuracy during critical tests and measurements, the controller should warm up for 30 minutes beforehand, once switched on.

6.3 Applications and their functions

The area of the display with the blue field takes up about two thirds of the entire screen. This area contains the pressure output reading, the set point, the active transducer range, units of measure, limits and a choice between the control modes such as measure, control or vent.

The sidebar to the right (black field) is used for entering data, adjusting the environment parameters, defining parameters for remote operations, and making choices in the configuration. Several different sidebars can be accessed from the main screen to achieve different objectives. More-detailed explanations follow in the following sub-chapters.

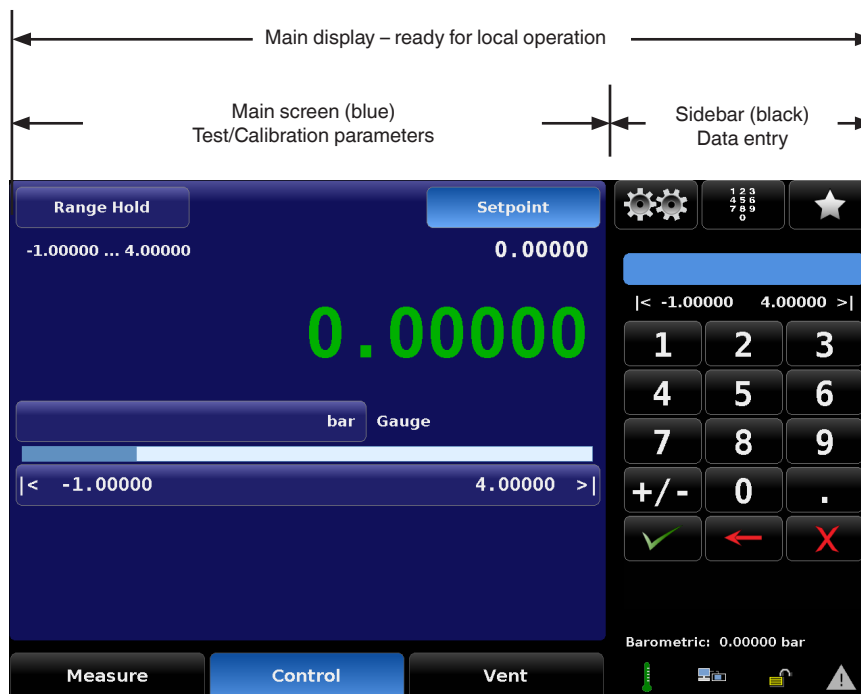

6. Operation via menu functions

6.3.1 Buttons, keys, switches, tabs, and further functions

Many of the words and symbols displayed on screen are active touch points, such that when touched or pressed something will change if it is an allowable action.

These touch-sensitive points are shown inside brackets such as **[Setpoint]**, the button seen in the upper middle corner of the main screen, see following figure. These touch points may be referred to as a button, a key (such as a number key), a toggle switch, a radio button also called a tab. Radio buttons and tabs are mutually exclusive buttons, if one in a group is chosen the others cannot be selected at the same time. Tabs are radio buttons that are located at the bottom of most menus. They open further menus in connection with the activity specified on the tab, or they enable a selection in connection with the open menu.

Individual screens are accessed by a series of press on tabs, buttons or symbols, which open screens within the hierarchy of the instrument. The menus and navigation to them are specified as follows: **“Symbol name” [Symbol] / [Tab] / [Button name]**.

For example the screen used to set the resolution of the instrument transducer would be designated by the navigational screen hierarchy, starting from the main screen, as follows: **Setup [] / [Sensor] / [Resolution]**. This convention is similar to a computer folder system and will be used to describe a screen and, inherently, how to navigate to it.

A press point will respond with an audible “beep” as a signal of acceptance.

A error tone is a signal that an illegal action was attempted, such as a number entry beyond the allowable range.

A word or symbol on a screen which does NOT respond to being touched or pressed is referred to in this manual as a label, window, monitor or an indicator. A label is merely a bit of information appropriate to the displayed activity, while a window is a variable, usually a numeric value. Also, some screens will display a line or more of text messages.

Labels, windows, monitors, indicators and text are not touch sensitive.

6.3.1.1 Main screen features

The data entry portion of the main screen is used primarily to input and adjust control set points and change main screen parameters.

All of the screens are set up into two display areas.

The left two-thirds of the main screen displays real-time information about the current configuration, the progress of the test being performed, the readings of the internal pressure transducer, range limits and designations as well as the instrument’s outputs.

The smaller area (data entry) on the right side, has the numeric keypad, variable sliders or radio buttons that all act to input alpha numeric information or mode changes relating to the test or calibration information being shown on the left.

6.3.1.2 Screen navigation

Buttons on the screen are shown with a gradient background. When inactive the buttons are shown with the gradient dark on the bottom and light on the top; when selected the button changes colour and is light on the bottom and dark on the top. Buttons are labelled in an intuitive fashion and when selected its function is obvious.

You can access the settings via the symbol with the two cogwheels []. The menu is structured exactly like the main screen: on the right for data input and on the left for the display. These setup screens are used for a variety of instrument settings, including, display, transducer, control, and remote interface settings. This area also contains the application used to calibrate the internal transducers plus various administrative, information and configuration settings. Detailed information about all setup screens can be found in chapter 7 “Basic settings”.

6. Operation via menu functions

6.3.2 Map of the main screen features

The following overview shows all the functions of the main screen. A CPC8000 without any extra display options is shown. The map includes a title box for each screen feature and the chapter number of the explanatory text about the feature and its use.

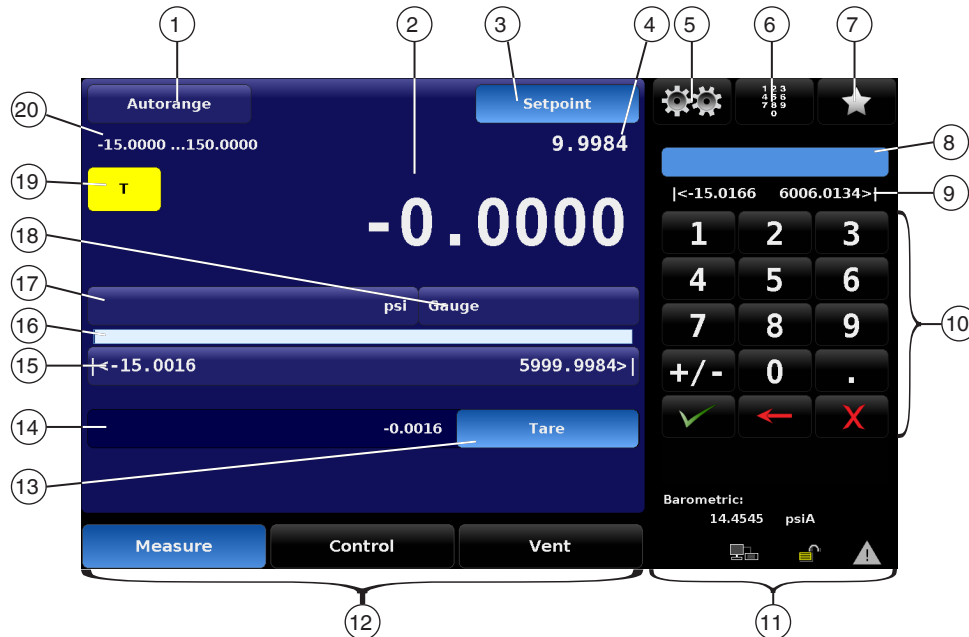

Pos.	Function	Further information
①	<ul style="list-style-type: none"> ■ Autorange (automatic range) ■ Range Hold 	See chapter 6.3.3 "Autorange / Range Hold"
②	Displayed pressure value	See chapter 6.3.4 "Displayed pressure value"
③	Set point button	See chapter 6.3.5 "Set point button"
④	Set point display	See chapter 6.3.6 "Set point display"
⑤	Setup	See chapter 6.3.7 "Settings" and 7 "Basic settings"
⑥	Set point entry methods	See chapter 6.3.8 "Set point entry methods"
⑦	Favourites	See chapter 6.3.9 "Favourites" and 7 "Basic settings"
⑧	Edit	See chapter 6.3.8.2 "Numeric keypad / Step"
⑨	Entry limits	See chapter 6.3.12 "Limits"
⑩	Numeric keypad	See chapter 6.3.8.1 "Numeric keypad"
⑪	Internal barometer Status bar	See chapter 6.3.10 "Status bar"
⑫	Operating modes <ul style="list-style-type: none"> ■ Vent ■ Control ■ Measure 	See chapter 6.3.17 "Operating modes"
⑬	Tare button for the secondary display	See chapter 7.1.3 "Calibration function"

6. Operation via menu functions

Pos.	Function	Further information
14	Secondary and tertiary display	See chapter 6.3.11 "Secondary and tertiary display"
15	Limits (control and entry)	See chapter 6.3.12 "Limits"
16	Bar graph	See chapter 6.3.13 "Bar graph"
17	Pressure units	See chapter 6.3.14 "Pressure units"
18	Pressure type	See chapter 6.3.15 "Pressure type"
19	Zero point calibration ■ Zero button ■ Tare button	See chapter 6.3.16 "Zero/Tare button"
20	Limits (range and entry)	See chapter 6.3.12 "Limits"

6.3.3 Autorange / Range Hold

The upper left corner of the main screen shows either **[Autorange]** or **[Range Hold]**. When **[Autorange]** is displayed the system will automatically select which of the available transducers (up to 3) to use at any time in a process for maximum accuracy. **[Range Hold]** indicates that a specific transducer has been assigned as the only active transducer. In either case the active transducer window immediately below the button will identify, by range, which is the active transducer of the moment.

- ▶ Press the **[Autorange]** / **[Range Hold]** button to cause the transducer assignment list to appear in the sidebar.
 - ⇒ The list will show a table of up to four choices, Autorange and one, two or three transducers, by range.
 - ⇒ The presently active range is highlighted.
 - ⇒ Press either one of the listed ranges, or **[Autorange]** and that choice is immediately effective.

If the CPC8000 is pressurised, only transducers whose range is equal to or higher than the internal pressure can be selected.



6. Operation via menu functions

6.3.4 Displayed pressure value

The large numbers on the screens are the pressure reading at the transducer connected to the Measure/Control port.

- If the display is green, the measured pressure is within a defined stable window during the selected time period.
- If the display is white, the pressure is outside the stable window.

See chapter 7.3.2 “Stable limits” for a detailed explanation and setup of the stable window.



The pressure reading will turn red if an external pressure is applied at the Measure/Control port that is 7 % greater than the upper limit of the active transducer. Each transducer is supplied with a pressure release valve set for 10 % over the calibrated pressure. Inherent internal safeguards are set to prevent overpressure.

6.3.5 Set point button

The **[Setpoint]** button will activate a sidebar data entry method to accept a new set point value. The set point value is displayed in the window just below the **[Setpoint]** button on the main screen, see chapter 6.3.6 “Set point display”. The set point value can also be adjusted incrementally in the sidebar by use of one of five set point entry methods:

- Numeric keypad
- A numeric step value assigned to the up [\blacktriangle] and down [\blacktriangledown] arrow buttons
- Percent steps
- A digital step assigned to the up [\blacktriangle] and down [\blacktriangledown] arrow buttons
- Programs

Procedures for making changes to the set point using these methods are covered in chapter 6.3.8 “Set point entry methods”.

6.3.6 Set point display

The set point value window is located immediately under the **[Setpoint]** button. It displays the current pressure set point (target value for the output pressure provided by the internal regulator when in control mode). To edit the set point value, first press the **[Setpoint]** button. This will activate the system for set point changes. The sidebar will display the default numeric keypad or a pre-chosen set point entry method. Further options to change the set point are described in chapter 6.3.8 “Set point entry methods”.



6. Operation via menu functions

6.3.7 Settings

By pressing the [] button in the sidebar opens the settings menu. Notice the bottom row of six subject tabs and the arrow on the left end of the row. Each tab will bring up a screen relevant to the subject in the tab title.





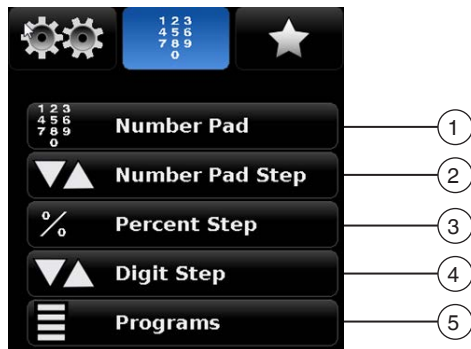

- If you want to return to the main screen, press the **Settings** [] button again to open the last opened settings menu.
- Operational information for the setup screens and their associated sidebars is contained in chapter 7 “Basic settings”.

6.3.8 Set point entry methods

Press the **numeric keypad** [] button in the middle of the top row will display the five-line menu as shown below.



Pos.	Symbol	Meaning
①	 Number Pad	Numeric keypad Returns the numeric keypad to the main screen. → See chapter 6.3.8.1 “Numeric keypad”.
②	 Number Pad Step	Numeric keypad step Stepwise input of the set point. → See chapter 6.3.8.2 “Numeric keypad / Step”.
③	 Percent Step	Percentage Input of the set point as a percentage. → See chapter 6.3.8.3 “Percentage value”.
④	 Digit Step	Digit step Numerical input of the set point. → See chapter 6.3.8.4 “Digital step”.
⑤	 Programs	Programs Activates a program and program control. → See chapter 6.3.8.5 “Program data entry”.

6. Operation via menu functions

6.3.8.1 Numeric keypad

The [Numeric keypad] button provides 10 digits for numeric entry, plus the decimal point and a sign key. The sign [+/-] button will toggle between positive and negative values. Each stroke on the buttons will echo in the blue input value window above the keyboard. A change between plus and minus values [+/-] can be entered at any time during the string entry. Pressing the enter [✓] button will accept the value and it will become the new set point.

If the input window holds an illegal value when the enter [✓] is pressed the system will respond with a an error tone and the entry will turn red. When that happens determine the cause of the rejection, delete the entry, and then enter a valid number.

Pressure limits are shown above the keypad and indicate the allowable range for entry. This is either the range of the active transducer, the full range of the instrument (when in autorange mode) or the range limits set in the setup controls limits menu, see chapter 7.3.1 "Maximum and minimum limits".

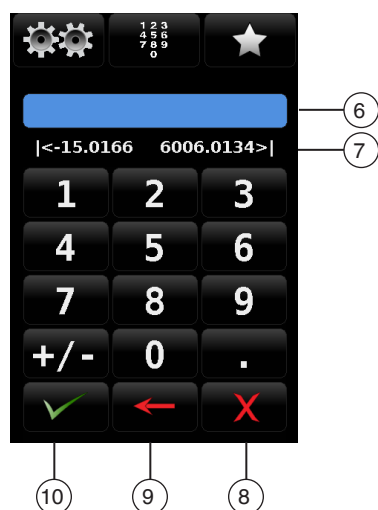

Pos	Symbol	Meaning
⑥		Input value window
⑦	< >	Pressure limits
There are three action buttons below the number buttons that operate on the numbers displayed in the input value window:		
⑧		Press the delete [X] button to delete the entire value showing in the echo window, see chapter 6.3.10 "Status bar" to start anew, or to abort.
⑨		Press the backspace [←] button to erase the last number entered in the string. Multiple presses will back out multiple digits.
⑩		Press the enter [✓] button to accept the value showing in the number echo window into the system for immediate use.

6. Operation via menu functions

6.3.8.2 Numeric keypad / Step

The “Number Pad Step” keypad functions in two different ways:

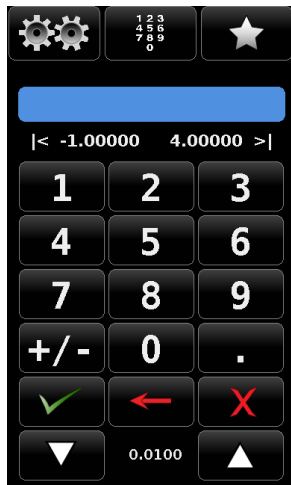

- A set point is entered via the numerical keypad.
 1. The desired set point is input as a number.
 2. Enter by pressing [✓].
⇒ The number will immediately be adopted as the set point.
- The set point is changed in steps by a fixed numerical value.
 1. Enter the numerical value by which the set point is to be changed stepwise.
 2. Press the [▲] or [▼] button in order to change the current value.
⇒ This number is used to decrease or increase the current set point value.
 3. Press the [▲] or [▼] button again until the desired set point is reached.
 4. Carry out this procedure for as long as is necessary for the measurement/calibration.



If this input is confirmed with [✓], then the numerical value is adopted as the new set point and not used as a step value.

6.3.8.3 Percentage value



In the digital percentage step mode it can select a set point value as a percentage of the pressure range of the device under test. It can choose between various percentage values by pressing on the desired button.

The set point is instantly changed to the selected percentage value of test item.

By pressing the button with the pressure range, the minimum and maximum pressure value of the test item can also be set. The settings for the step settings are then opened, in which the pressure range of the test item, the overrange and the percentage values can be set. Either predefined default values can be used as percentage values or they can be set individually.

The up [▲] or down [▼] button is associated with the digital step entry method, see chapter 6.3.8.4 “Digital step”. The set point is increased or decreased by the amount shown between the arrows.



Fig. 6.3.8.3-A – Percentage entry



Fig. 6.3.8.3-B – Step settings

6. Operation via menu functions

6.3.8.4 Digital step

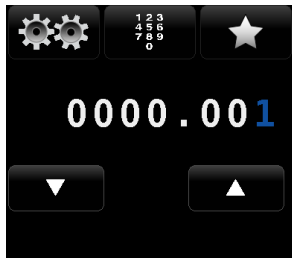

In the digital step data entry mode there is initially a string of six white zeros (0) and one blue numeral one (1) across the top as shown in the figure. Any one of these zeros can be converted to a blue 1 by touching it.

1. Slide a finger over the zeros.

⇒ The white zero (0) changes into a blue one (1) and that digit is now activated to be changed.

2. With the [▲] or [▼] buttons, respectively, increase or decrease the set point digit that corresponds to the blue one's (1) position by a value of 1.

Example:

The set point in the display below is at 50.0000, and this should be changed to 51.0000, 52.0000, 53.0000 ... and so on.

1. For stepwise digit entry, press the digit that corresponds to the position of the unit to be changed in the set point.

⇒ The white zero (0) changes into a blue one (1).

2. Increase the activated number with the [▲] button.

⇒ The set point is increased stepwise.



If the resolution of the instrument were set to 4 then the right most digit in the digital step screen would correspond to the least significant digit of the set point and the left two digits in the digital step screen would not be used.

6. Operation via menu functions

6.3.8.5 Program data entry

The program data entry method provides an automated way to interact with the CPC8000. Many setting or process that can be entered manually can be programmed into the unit and saved and used in the Program portion of the data entry screen. Programs are prepared and stored in the **Setup** [⚙️] / **[Application]** / **[Program]** screen. In chapter 7.5.3 “Programs” the program creation, editing and storage is described.



Fig. 6.3.8.5-A – “Current program data” screen

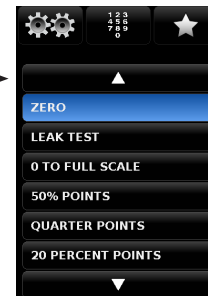

Fig. 6.3.8.5-B – “Program data selection” screen

- ▶ After selecting the program, press **Play** [▶] to start the program.
- ▶ Using **Pause** [||], at any time, the program can be stopped at the current step.
- ▶ To set it running again, press **Play** [▶].
- ▶ To move forward or backwards in the program press the back [◀] button or the forward [▶▶] button.
- ▶ The **stop** [■] button will stop the program and place the CPC8000 in measure mode.

6.3.9 Favourites

Using the **Favourites** [★] button, programs that are used frequently can be saved. There are also various preset programs that can be used to carry out a leak test and a zero point adjustment for each transducer. Programs that are displayed in the favourites menu are chosen in the **Setup** [⚙️] / **[Applications]** / **[Favourites]** screen. See chapter 7.5.2.5 “Calibration adjustment procedure” to select displayed favourites.







6. Operation via menu functions

6.3.10 Status bar

Located below the number pad is a status bar consisting up to four symbols.



EN

Symbol	Function	Meaning
	Head height	Indicates that a connected instrument or test item is set to a different level from the CPC8000 transducer.
	Remote	Lights up green to indicate there is a remote connection established. → See chapter 7.4 “Remote” tab”
	Screen lock	This symbol indicates the status of the touchscreen: ■ Locked ■ Unlocked for manual operation
	Error indicator	A yellow triangle indicates that there is an error recorded in the error register. Pressing the yellow error indicator will open the Setup [] / [Applications] / [Troubleshoot] screen where errors can be viewed. → For more information, see chapter 7.5.6 “Troubleshoot”. The error register will clear itself when it is viewed, however, this does not correct the error. A corrective action still must be specifically addressed.

6.3.11 Secondary and tertiary display

In the lower area of the main screen there are two data lines in which two entries can be selected from a list.

The first line is defined as **secondary display** and the other line as **tertiary display**. The list of choices are identical for both lines. The list of choices can be found under **Settings** [] / **[Configuration]** / **[Secondary Display / Tertiary Display]** as shown in Figure 6.3.11-B. An explanation on how to setup and choose options for this area is given in chapter 7.1.2 “Secondary and tertiary display”.



Fig. 6.3.11-A – Secondary and tertiary displays

6. Operation via menu functions

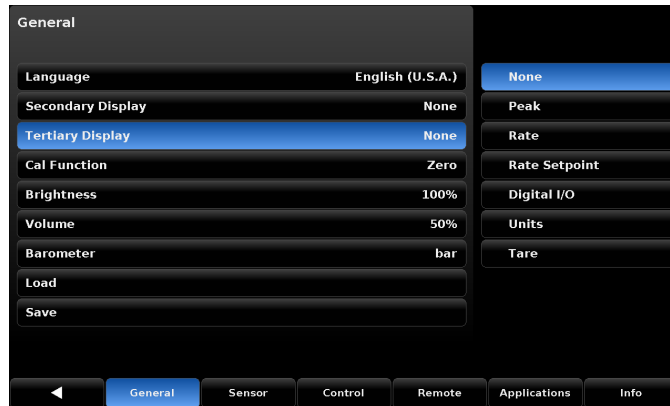



Fig. 6.3.11-B – “Display choices” screen

6.3.12 Limits

Limits are shown in three places in the main screen. The “**Range Limits**”, “**Control Limits**” and “**Entry Limits**” shown in the following figure can show two different readings depending on settings.

- The **Range Limits** shows the limits of the range selected in **Range Hold** mode or the limits of the active transducer in **Autorange** mode.
- The “**Control Limits**” are the limits entered into the **Setup** [] / [**Control**] / [**Upper Limits**] / [**Lower Limits**] screen, see chapter 7.3.1 “Maximum and minimum limits”. The **Control Limits** limit the value that can be entered as a set point.
- The **Entry Limits** are equal to the lessor of the **Control Limits** or the **Range Limits** (when in **Range Hold** mode).



6. Operation via menu functions

6.3.13 Bar graph

The bar graph is always active and reports in real time the pressure at the Measure/Control port. This provides a visual comparison between the actual pressure and the user selected control limits.

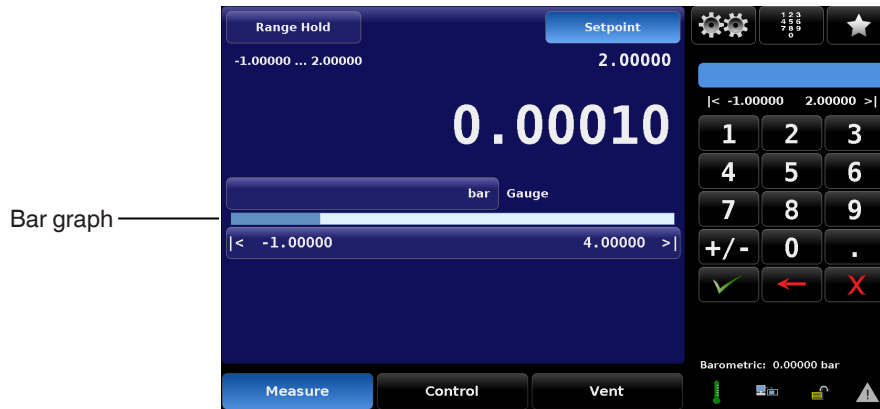

Bar graph

6.3.14 Pressure units

The pressure units that the CPC8000 is currently using are displayed very near the centre of the main screen, just above the bar graph. To change the pressure unit, press the current unit's symbol. Then, the units menu will be displayed in the sidebar. There are forty pre-defined pressure units listed in seven menu pages so it may be necessary to scroll through several pages to locate the desired units. The [▲] or [▼] buttons will scroll to the next page until the desired pressure unit is found. Press the line in the menu with the pressure unit to activate it.

Pressing the [▲] and [▼] buttons will scroll continuously through all units. After reaching the end, the run starts again at the beginning.

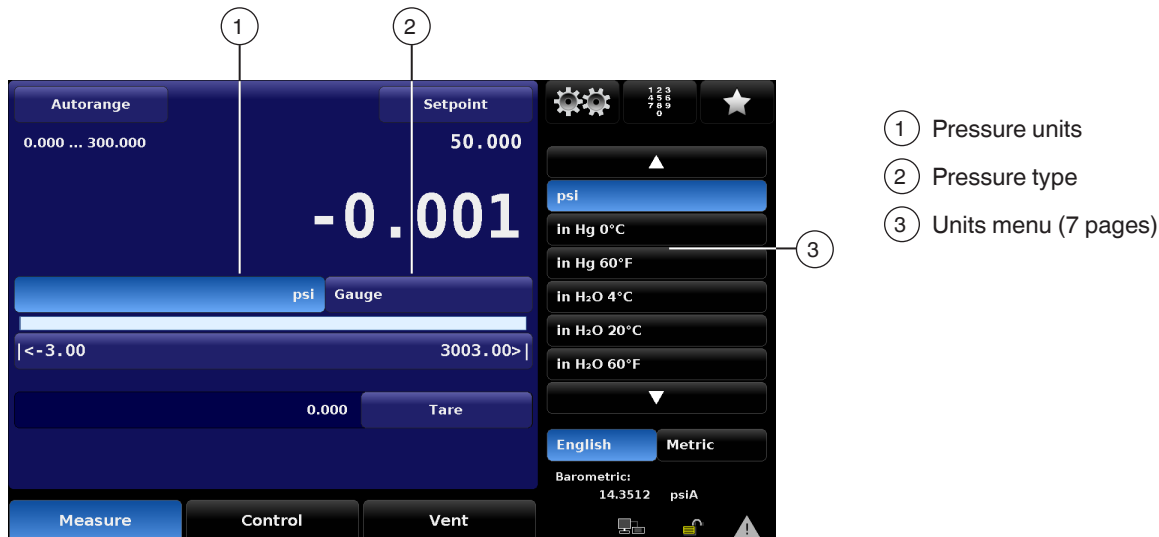

- 1 Pressure units
- 2 Pressure type
- 3 Units menu (7 pages)

There are several tables of conversion factors for pressure units in chapter 14 "Annex". The PSI table includes the factors for conversion to or from PSI to all of the other available units. Another table uses "bar" as the basis for conversion factors to or from most of the more common alternative units.

6. Operation via menu functions

6.3.15 Pressure type

Pressure type is a label of either **[Gauge]** or **[Absolute]** according to what type of transducer is in the CPC8000. The exception is that this feature is an active switch which toggles between **[Gauge]** and **[Absolute]** if there is a barometer option included in the system. The barometer is used to emulate gauge pressure when the native transducers are absolute and absolute when the native transducers are gauge.

→ See chapter 4.9.3 “Barometric reference transducer” for details of the barometric reference transducer option.

6.3.16 Zero/Tare button

The **Zero** [] button appears in the main screen, if the **Zero** function has been chosen in the Setup screen. An explanation on how to setup and choose the **[Zero]** button is given in chapter 7.1.3 “Calibration function”.

If the instrument is measuring absolute pressure, a barometer is required to be used as the reference standard to perform the zero. After pressing the **[Zero]** button, a keyboard for one-point calibration is displayed. If the instrument is measuring gauge pressure, pressing the button will set the current reading to zero. If the instrument is in emulation mode (absolute or gauge) then the value will not be saved to the transducer but only as a temporary adjustment while in emulation mode. After exiting the emulation mode or after a power cycle, the temporary adjustment will be cleared. The zero adjustment for an instrument not in emulation mode will be saved to the transducer as if one-point calibration had been performed.

- Figure 6.3.16-A shows an instrument with gauge transducers and activated **[Zero]**. The right side of the screen displays the status of the zeroing process. The process can be aborted at any time by pressing the Abort **[X]** button.
- Figure 6.3.16-B shows an instrument with absolute transducers with **[Zero]** button enabled.



Fig. 6.3.16-A – Zero active in gauge pressure mode



Fig. 6.3.16-B – Zero active in absolute pressure mode

6. Operation via menu functions

The **Tare** [] button will be displayed whenever “Tare” is active. The button will be cautionary yellow to indicate the pressure reading is affecting by the offset.

EN



Fig. 6.3.16-C – Tare active

6.3.17 Operating modes

The CPC8000 has three operating modes: **Measure**, **Control**, and **Vent**. After the system has been switched on, and after a subsequent short self-test, the instrument will automatically be placed in **Measure** mode. It can switch between the operating modes using the selection buttons at the bottom of the display.



When switching from **Control** mode to **Measure** mode, the system will not be vented and the last applied pressure will be locked in the system by means of a solenoid valve.



Pos.	Mode	Function
①	Measure	In measure mode the CPC8000 acts like a precision pressure measuring instrument and measures the pressure applied at the Measure/Control port. If the control mode was the last used mode before switching into measure mode, the last controlled pressure is held in the test assembly. → See chapter 6.3.17.1 “Measure mode”

6. Operation via menu functions

Pos.	Mode	Function
②	Control	In control mode the CPC8000 provides a controlled pressure at the Measure/Control port equal to the set point value. → See chapter 6.3.17.2 "Control mode"
③	Vent	The vent function will vent the system to the atmosphere, including the test assembly connected to the Measure/Control port. → See chapter 6.3.17.3 "Vent mode"

EN

6.3.17.1 Measure mode

In measure mode, the instrument measures the pressure at the transducer connected to the Measure/Control port. The measure mode is activated by pressing the **[Measure]** button.



If the pressure is beyond the permissible measurement range, the pressure reading is displayed in red instead of white figures. As soon as a pressure of approximately 110 % full scale is reached, an integrated safety relief valve opens and releases the pressure into the inside of the instrument. The regulator is not active in measure mode.

- ▶ The set point can be entered in measure mode.
- ▶ The control mode is activated by pressing the **[Control]** button.
⇒ The CPC8000 will drive to the setpoint.

6. Operation via menu functions

The following figure shows the state of the isolation valves in measure mode.

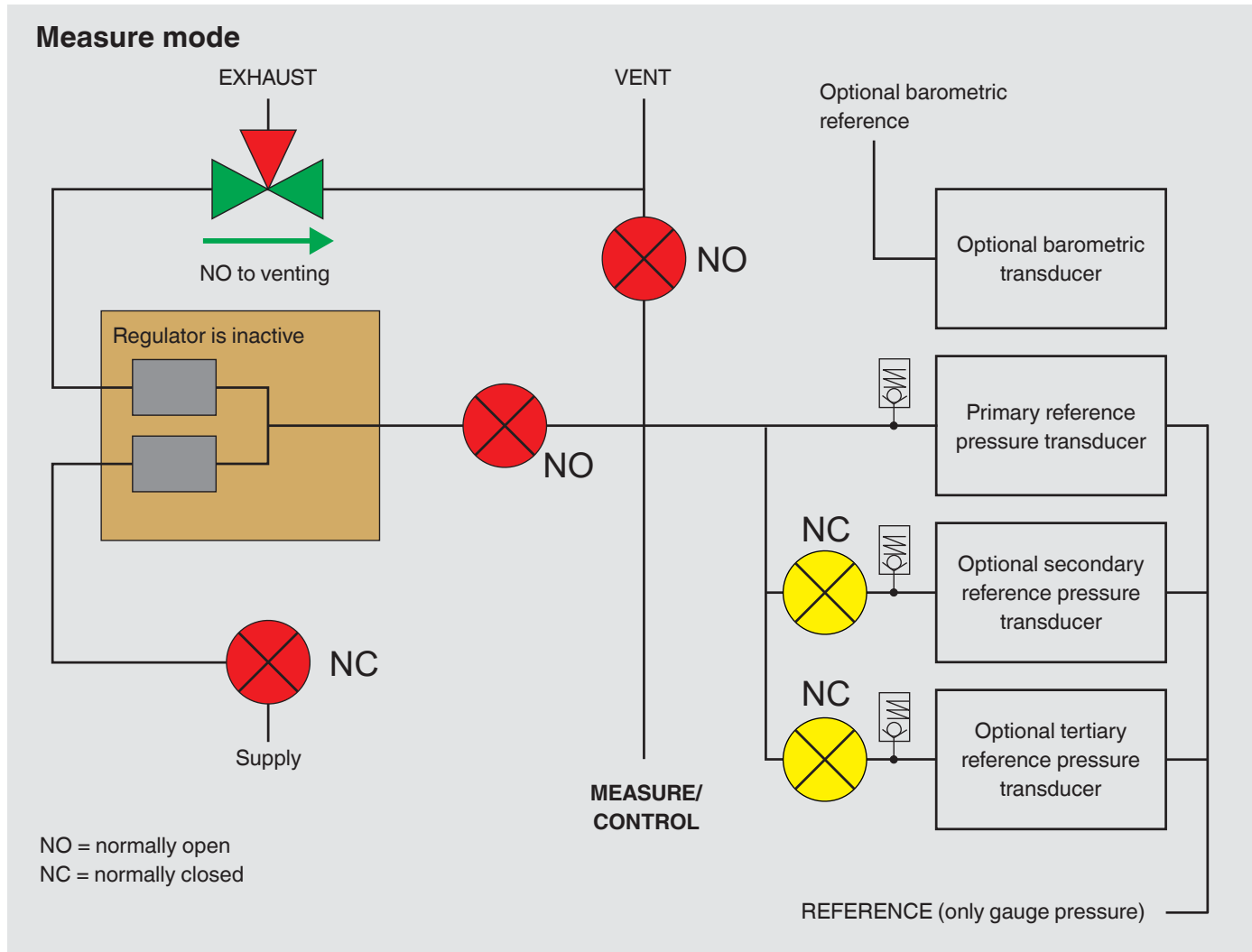

Valve is OPEN



Valve is CLOSED



Conditional status



At 10% over the range of the pressure transducer, set pressure relief valve



The pressure transducer isolation valve (yellow valve) is closed:

1. In **Autorange** mode, if the system pressure is outside the range of the connected reference pressure transducer.
 2. In **Range Hold** mode, if another reference pressure transducer is selected.
- Otherwise it is open

Fig. 6.3.17.1 – Isolation valves in measure mode

6. Operation via menu functions

6.3.17.2 Control mode

In control mode, the instrument provides a precise pressure output at the test port. The indication of the current pressure value will turn green when the set point has been reached and the stable window settings have been satisfied.



The control mode is activated by pressing the **[Control]** button in the main menu. The control mode can be accessed from the measure mode or the vent mode by pressing the **[Control]** button. In the control mode the CPC8000 acts as a precision pressure controller and provides a stable pressure output at the Measure/Control port.

In order to ensure that the controller is correctly configured for the task it is to perform, the following measures must be taken and the respective parameters must be set in the **Setup [⚙️]** menu.

- In order to control pressures close to or below atmospheric pressure, a vacuum pump should be connected to the exhaust port.
- The control speed can be set in the **Setup [⚙️] / [Control] / [Rate setpoint]** screen. The control rate can be set between 0.001 % of range/sec to 10 % of range/sec.
- Control limits can be set in the **Setup [⚙️] / [Control] / [...limits]** screen.

6. Operation via menu functions

The following figure shows the state of the isolation valves in control mode. Ensure that the regulator is active in control mode.

EN

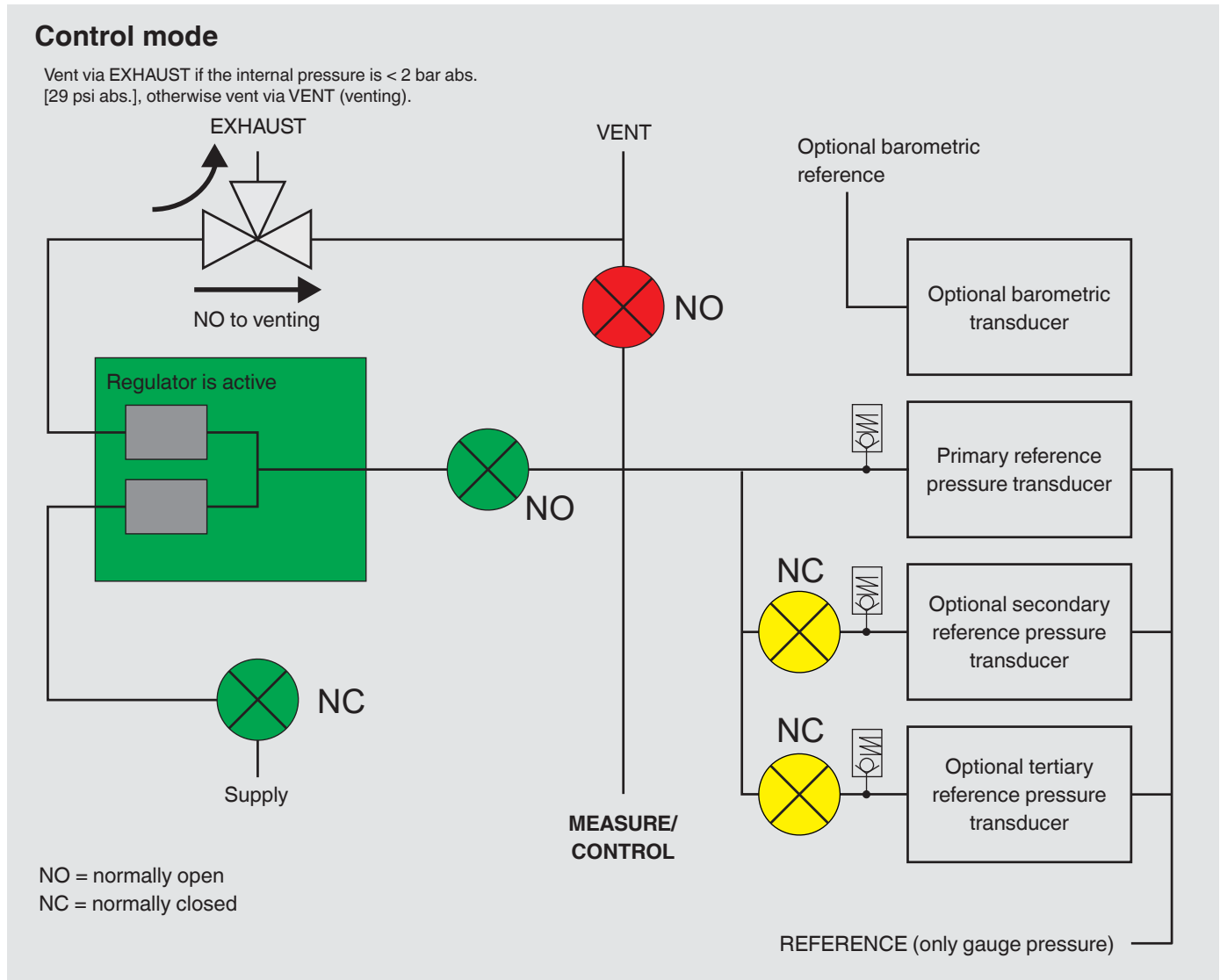

Valve is OPEN



Valve is CLOSED



Conditional status



At 10 % over the range of the pressure transducer, set pressure relief valve



The pressure transducer isolation valve (yellow valve) is closed:

1. In **Autorange** mode, if the system pressure is outside the range of the connected reference pressure transducer.
 2. In **Range Hold** mode, if another reference pressure transducer is selected.
- Otherwise it is open

Fig. 6.3.17.2 – Isolation valves in control mode

6. Operation via menu functions

6.3.17.3 Vent mode

Vent mode vents the pneumatic system and shuts off the supply. The vent mode can be activated from the measure or control mode by pressing the [Vent] button. Internal system pressure will be vented through the vent port.



WARNING!

Damage to the device under test

Venting will cause a sudden loss of pressure in the system and the plumbing connected to the measure control port.

- ▶ Make sure that the test item is not damaged during venting.



WARNING!

In some cases venting will exhaust high velocity air from the vent port. Personnel and sensitive equipment should not be in close proximity to the vent port during venting.



WARNING!

HIGH SOUND LEVELS!

Pressures from 0 ... 70 bar [0 ... 1,000 psi] and up can generate sound levels above 80 dbA for brief periods when they are exhausted directly to atmosphere. A silencer is provided for connection to the vent port. It is the operator's responsibility to measure sound levels at whatever point 1 m [3.28 ft] from the equipment that has the highest sound pressure level. At levels above 80 dbA, use of protective ear pieces can reduce these higher levels to a safe level.



Note

The high pressure can lead to a loud noise on venting. Personnel should wear a hearing protection instrument when working with high pressures.

6. Operation via menu functions

The following figure show the state of the isolation valves in vent mode.

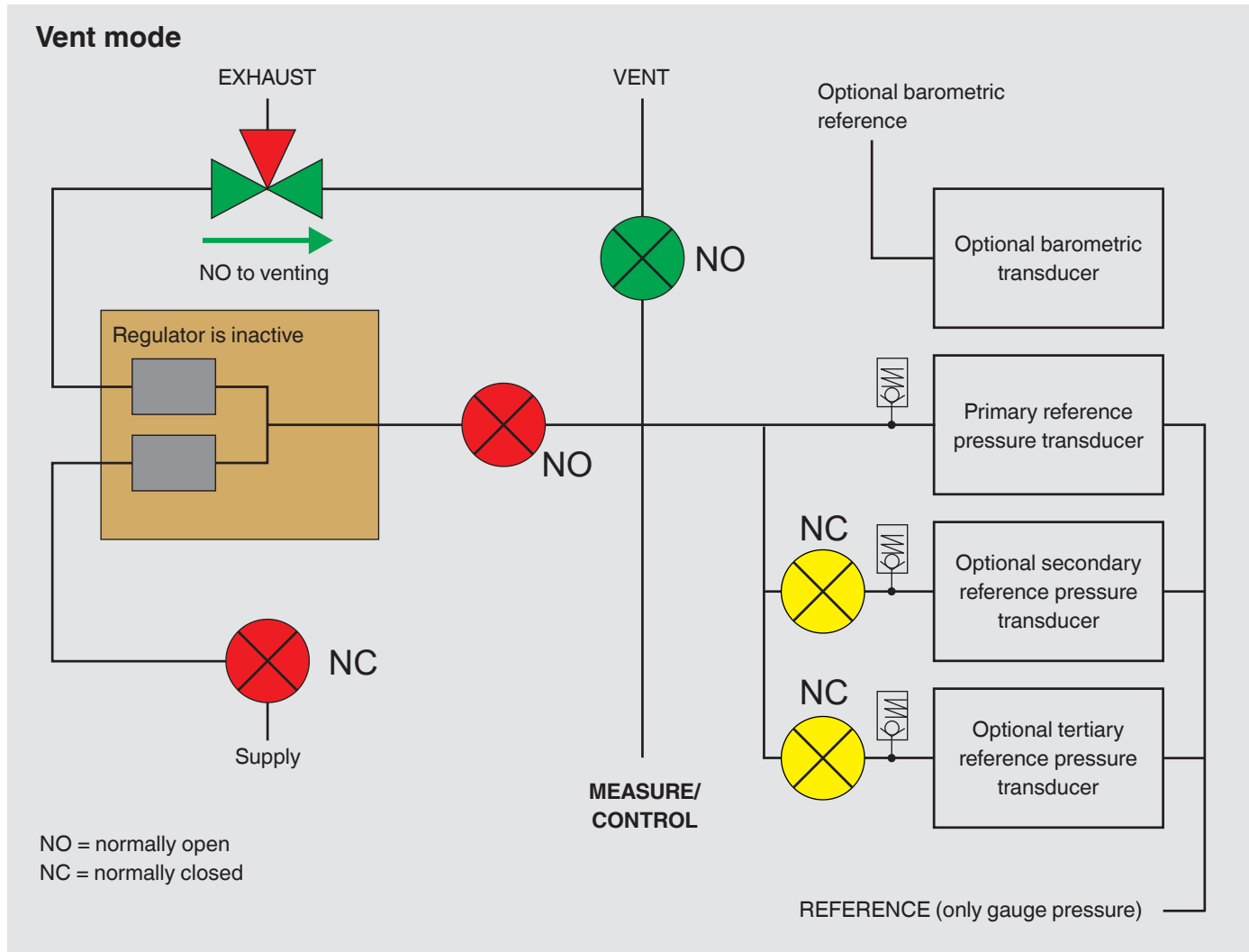

Valve is OPEN



Valve is CLOSED



Conditional status



At 10% over the range of the pressure transducer, set pressure relief valve



The pressure transducer isolation valve (yellow valve) is closed:

1. In **Autorange** mode, if the system pressure is outside the range of the connected reference pressure transducer.
 2. In **Range Hold** mode, if another reference pressure transducer is selected.
- Otherwise it is open

Fig. 6.3.17.3 – Isolation valves in vent mode

6.3.17.4 State of the isolation valves when the CPC8000 is off

When the CPC8000 is switched off, the valves revert to their normal state: either **Normally Open (NO)** or **Normally Closed (NC)** as indicated before.

7. Basic settings

7. Basic settings

After the instrument has been switched on, the main screen is shown. After pressing the **Settings** [] button, one accesses the setup level via the sidebar. This is where the parameters are set up or instrument settings are made.



The following is a menu tree that shows the general structure of the Setup menus. The bullet points in **blue** represent views for which the first-level password is required; the **red** points require the second-level password.

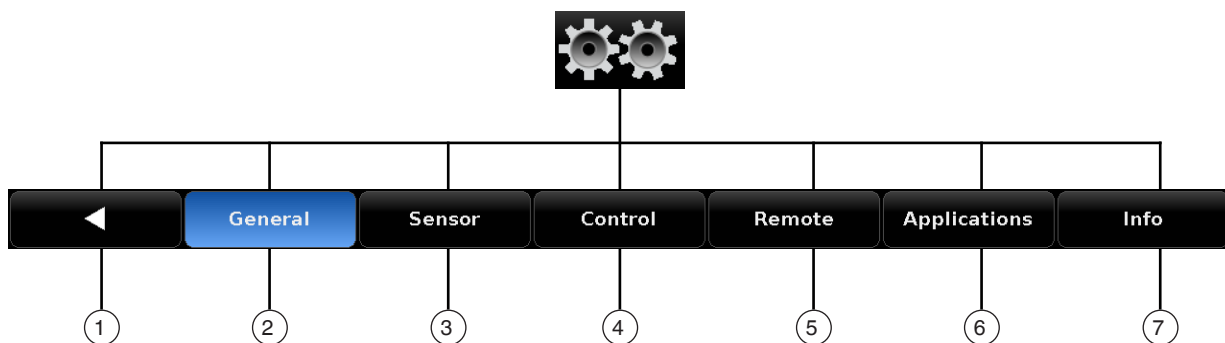

Pos.	Mode	Function
①	◀	Return to the previous screen or main screen
②	General	Setting of the following functions: <ul style="list-style-type: none"> ■ Language ■ Secondary display ■ Secondary display ■ Calibration function ■ Brightness ■ Volume ■ Barometer ■ Load ■ Save
③	Sensor	Setting of the following functions: <ul style="list-style-type: none"> ■ Filter ■ Resolution ■ Units ■ Rate units ■ User units 1 – Base unit ■ User units 1 – Multiplier ■ User units 2 – Base unit ■ User units 2 – Multiplier

14739768.01 11/2024 en-co based on 018503001AT en-um 12/2022

7. Basic settings

EN

Pos.	Mode	Function
④	Control	Setting of the following functions: <ul style="list-style-type: none"> ■ Maximum limit ■ Minimum limit ■ Stable limits ■ Stable delay ■ Rate upper limit ■ Rate lower limit ■ Rate set point ■ Vent limit ■ Vent rate
⑤	Remote	Setting of the following functions: <ul style="list-style-type: none"> ■ Remote setup ■ IEEE-488 command set ■ IEEE-488 address ■ Ethernet ■ IP ■ Netmask ■ Gateway ■ Port ■ DHCP serial ■ Baud ■ Data bits ■ Stop bits ■ Parity ■ Echo
⑥	Application	Setting of the following functions: <ul style="list-style-type: none"> ■ Programs ■ Favourites ■ Digital I/O ■ Troubleshooting ■ Adaptation ■ Software
		Second-level password is required <ul style="list-style-type: none"> ■ One-point calibration ■ Two-point calibration ■ Linearize ■ Height pressure correction
		Second-level password is required <ul style="list-style-type: none"> ■ Tune ■ Admin
⑦	Info	Instrument-specific data are displayed

7. Basic settings

7.1 “General” tab

7.1.1 Language

The languages available in the CPC8000 are displayed by pressing the **Settings** [] / [General] / [Language] button. The active language is indicated on the right side of the [Language] button. When the [Language] button is pressed, the sidebar will show the languages that are available. Pressing the desired language will make that language active on every screen in the CPC8000.

EN



7.1.2 Secondary and tertiary display

Additional parameters that may be required for tests or calibrations can be displayed in secondary display and tertiary display. By pressing the **Settings** [] / [General] / [Secondary Display] or [Tertiary Display] button, the following parameters are available in the sidebar:

- None
- Rate Setpoint
- Tare
- Peak
- Digital I/O
- Uncertainty
- Rate
- Unit
- Motor position

Press the desired parameter to display it on the right in the [Secondary Display] or [Tertiary Display] button.

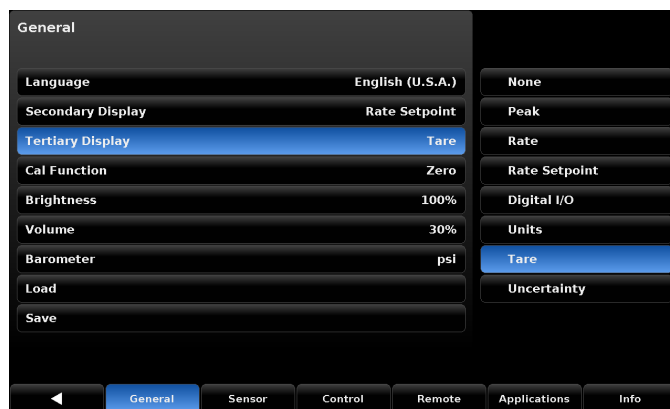

7. Basic settings

7.1.3 Calibration function

By pressing the **Settings** [] / **[General]** / **[Cal function]** button, the **[Zero]** can be activated in the main screen. The following parameters are available in the sidebar:

- None
- Zero
- Tare

Selecting **[Zero]** activates the zero point setting, selecting **[None]** deactivates it again. By pressing the desired parameter, it is displayed on the right in the **[Cal function]** button.

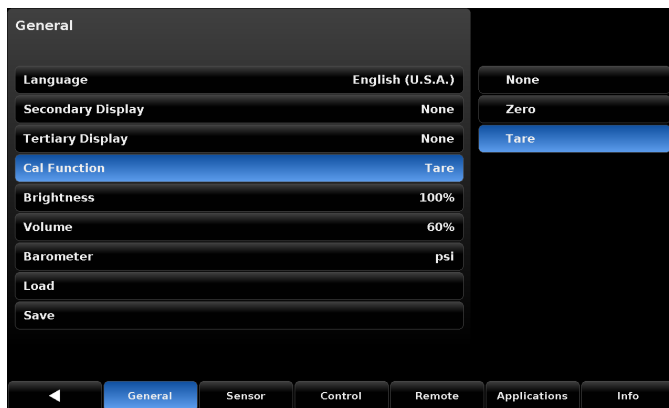

Figure 7.1.3-A shows that the selection of the tare option corresponds to the auxiliary display.

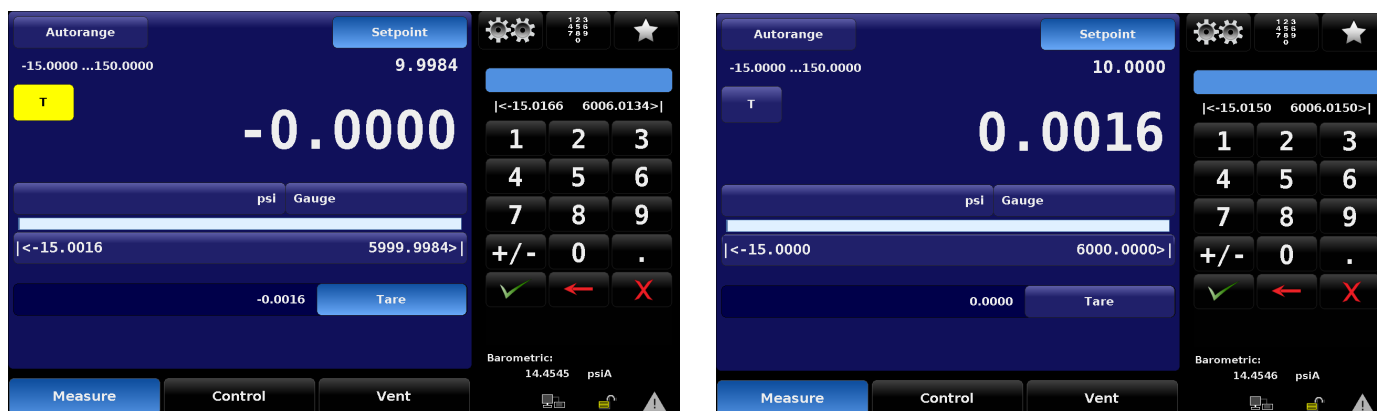

Fig. 7.1.3-A – Tare function activated – Auxiliary displays

Figure 7.1.3-B shows tare function deactivated when a percent of range units are active.



Fig. 7.1.3-B – Tare function deactivated

7. Basic settings

7.1.4 Brightness

This is where the brightness of the display is set. The setting is made using a bar graph from 0 ... 100 % in 10 % steps.

By pressing the **Settings** [] / **[General]** / **[Brightness]** button, a bar graph with the corresponding levels is shown in the sidebar. This is an overview of the various brightness levels. It can be changed by sliding ones finger up and down on the bar graph or simply touching an area on the graph that corresponds to the desired volume level.

Pressing the desired brightness also shows the percentage on the right-hand side of the **[Brightness]** button.

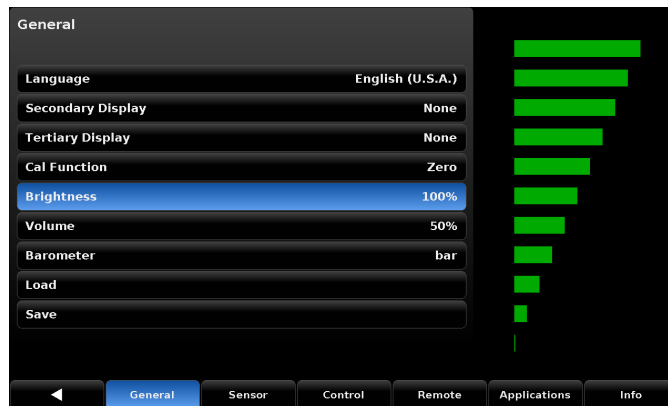

7.1.5 Volume

This is where the general volumes for the acoustic signals of the instrument are set. The setting is made using a bar graph from 0 ... 100 % in 10 %-steps.

By pressing the **Settings** [] / **[General]** / **[Volume]** button, a bar graph with the corresponding levels is shown in the sidebar. This shows the relative volumes available. It can be changed by sliding ones finger up and down on the bar graph or simply touching an area on the graph that corresponds to the desired volume level.

Pressing the desired volume also shows the percentage on the right-hand side of the **[Volume]** button.

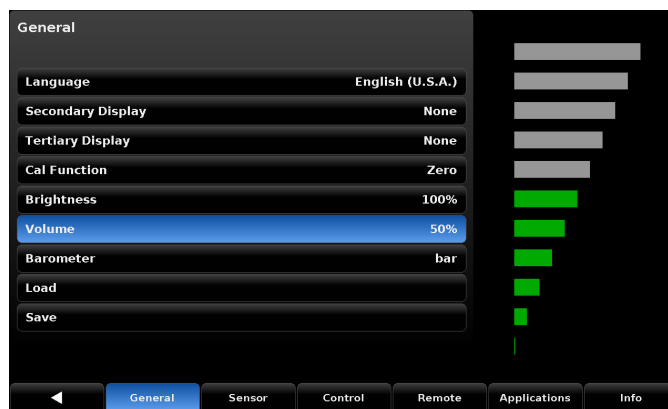

7. Basic settings

7.1.6 Barometer (Units)

By pressing the **Settings** [] / **[General]** / **[Barometer]** button, a selection of **English** or **Metric** units are displayed in the sidebar. Any of these units can be chosen from this list for the barometric readout. By pressing the desired unit, this is displayed on the right in the **[Barometer]** button. The barometric pressure readout can be seen still on the bottom right of the main screen.

EN

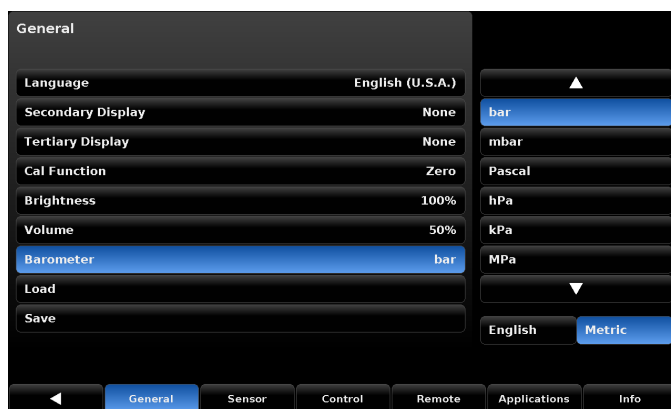

7.1.7 Load configuration

Each configuration can store a complete set of parameters and settings. Configurations can be further recalled (loaded) as needed. The configurations contain settings for the following set of parameters:

- Lower limit
- Step
- Stable window
- Rate stable delay
- Filter
- Rate units
- Volume
- Upper limit
- Rate setpoint
- Stable delay
- Vent rate
- Resolution
- Secondary units
- Setpoint
- Rate step
- Rate stable window
- Emulation mode (gauge/absolute)
- Units
- Brightness

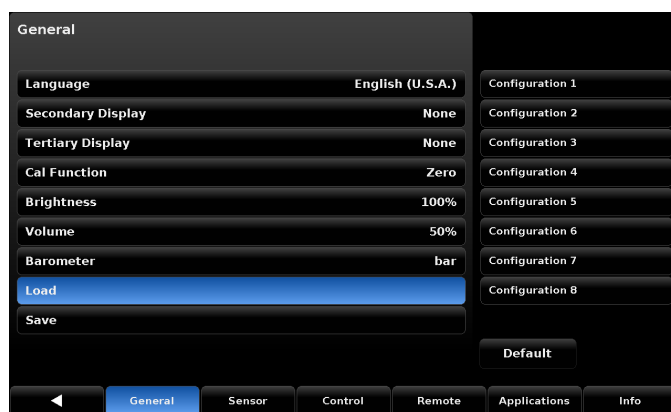

Explanations on setting up the individual configurations can be found in chapter 7.1.8 “Save configuration”.



By pressing the **Settings** [] / **[General]** / **[Save 1]** button, all saved configurations are displayed in the sidebar and a configuration can be selected.

When one configuration is chosen its saved parameters and settings will be active in the instrument.

7. Basic settings

7.1.8 Save configuration

All configurations for the instrument are stored under this function. Up to 8 configurations can be programmed and saved. Configurations can be used to save time in setting up parameters for specific calibration needs. For example, there may be a requirement to calibrate a transducer with 7 bar [100 psi], and an upper limit of 7.2 bar [105 psi] cannot be exceeded and the rate of pressure change cannot exceed 0.3 bar [5 psi] per second. These parameters can be set and saved under one of the configuration numbers and reloaded before the test is run.

By pressing the **Settings** [] / **[General]** / **[Save]** button, a list with numbered configurations is displayed in the sidebar. After selecting a number and confirming by pressing [], the current instrument settings will be stored under this configuration number. All instrument settings which can be saved as a configuration, are listed in chapter 7.1.7 “Load configuration”.

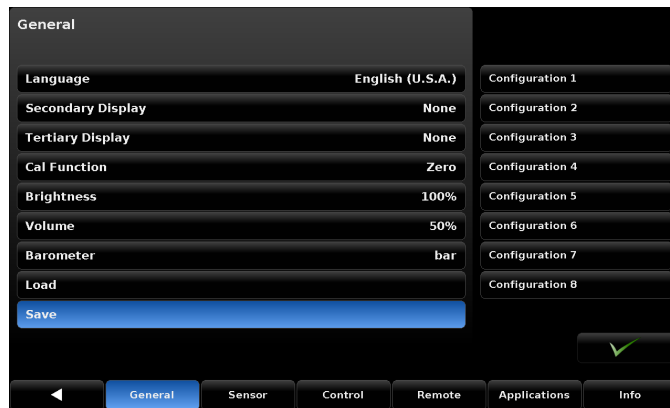

7. Basic settings

7.2 “Sensor” tab

Under this tab can be found the parameters of all installed pressure transducers. Settings made here affect the displayed and remote output value of the instrument’s measured pressure.

EN

7.2.1 Filter (sensor filter)

The sensor filter affects the output pressure displayed by the instrument and filters out small pneumatic and electrical deviations from the output value of the pressure transducer. This is achieved by mathematical interpolation of the recorded value with a low-pass filter, which is applied to the electrical output value of the pressure transducer.

By pressing the **Settings** [] / **[Sensor]** / **[Filter]** button, the following filter settings will be displayed in the sidebar:

■ Off ■ Low ■ Normal ■ High

The settings for the filter are made by pressing the corresponding button on the right-hand side. The setting will be displayed in the right of the **[Filter]** button.

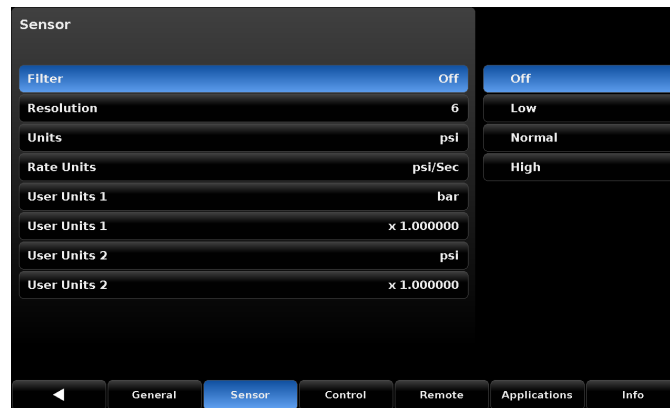

7.2.2 Resolution (decimal places)

The displayed resolution of the pressure value can be selected in the menu in the right-hand sidebar. The resolution is the number of decimal places that will be shown in the pressure indication within all screens of the instrument.

The user can change the resolution to 4, 5 or 6 decimal places with CPR8000 transducers.

By pressing the **Settings** [] / **[Sensor]** / **[Resolution]** the decimal places are displayed in the sidebar. The settings for the decimal places for the pressure output are made by pressing the corresponding button on the right-hand side. The setting will be displayed in the right of the **[Resolution]** button.

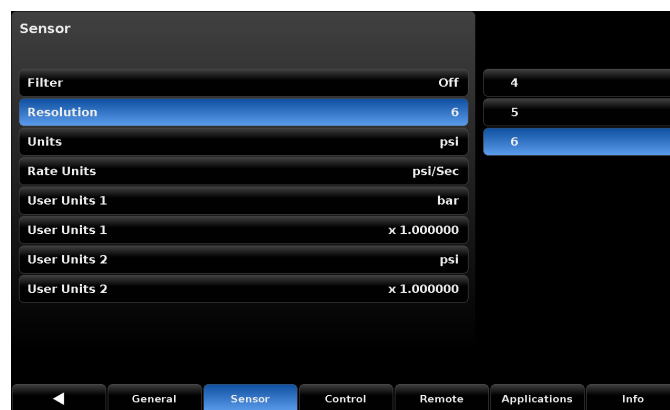

7. Basic settings

7.2.3 Units

There are 38 different units and 2 user-defined pressure units available.

By pressing the **Settings** [⚙️] / **[Sensor] / [Units]** button, all available pressure units are displayed in the sidebar. In the right sidebar, a set of 6 selectable pressure units are always displayed. The [▲] and [▼] buttons can be used to navigate up and down. The setting for the unit are made by pressing the corresponding button on the right-hand side. The setting will be displayed in the right of the **[Unit]** button.

Selecting any of these pressure units will change the measuring unit for the pressure sensed by all of the internal pressure transducers. These are also used for readings via remote control. This same selection of pressure units can be accessed directly from the main screen by pressing the button displaying the current units.

A complete overview of the specified pressure units is given in chapter 14 “Annex”.



7.2.4 Rate units

By pressing the **Settings** [⚙️] / **[Sensor] / [Rate Units]** button, the time units in seconds **[Sec]** and minutes **[Min]** are displayed in the sidebar. The time units are set by pressing the corresponding button on the right-hand side. The time units will be displayed in the right of the **[Rate Units]** button.

If a time unit is selected, this is used for all rate functions of the instrument, including **[Rate Setpoint]** and **[Vent rate]**. If this unit is changed, all rate set points are adjusted so that they mathematically correspond to their current setting.

Example:

If, for example, **[Rate Setpoint]** is set with 60 psi/min, a change in the time unit to seconds would change the **[Rate Setpoint]** to a calculated 1 psi/sec, see chapter 7.3.4 “Rate setpoint”.



7. Basic settings

7.2.5 User units

In the **Setup** [] / **[Sensor]** tab there are several buttons with prefixes **User Units**. These are used to setup the base unit and multiplier used to define **[User Units 1]** and **[User Units 2]**. For **[User Units 1]** and **[User Units 2]** the process is the same. Selecting the first **[User Units #]** will display a choice of **[psi]**, **[bar]** or **[Pascal]** in the sidebar. Choosing one of these base units will form the basis of the equation that defines the **[User Units #]** chosen. Immediately below the first **[User Units #]** button is the **[User Units #]** multiplier button that indicates the current multiplier. When pressed, it will display a numerical keypad in the sidebar where a new multiplier can be entered.

These two choices are used to calculate the value of the **[User Unit #]** by the following equation:

User unit = 1 base unit x multiplier

Example:

For example if a unit is needed, that is not currently available from the 40 choices, for instance tons per square metre (tsm), then the psi conversion factor for this can be found and is: 1 psi = 0.703069 tsm. In this instance psi would be entered as the base unit and 0.703069 as the multiplier. The new user unit associated with this base unit and multiplier would now be displayed when that User Unit is chosen in the main menu or on the **Setup** [] / **[Sensor]** / **[Units]** screen.

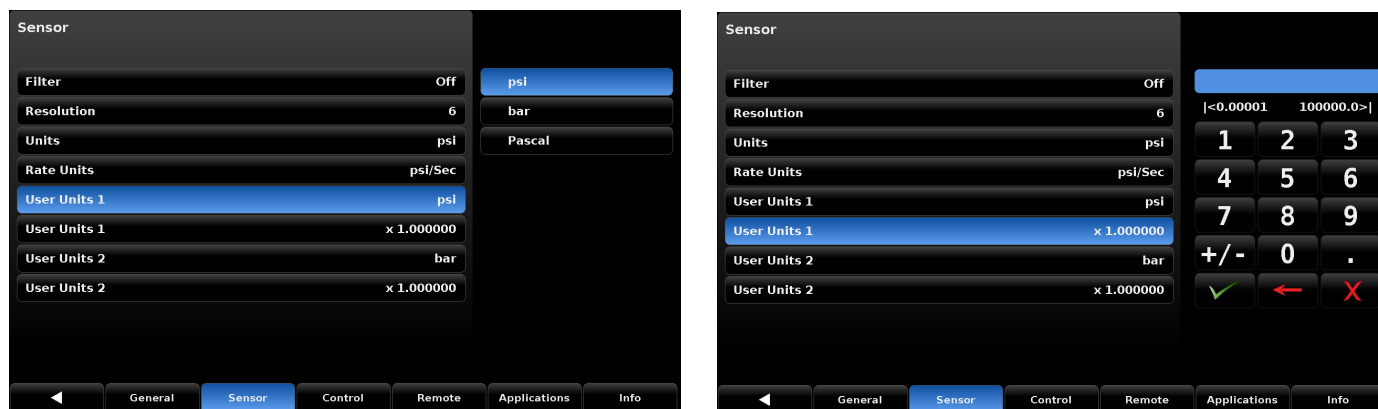



Fig. 7.2.5 – User units and user units multiplier

7. Basic settings

7.3 “Control” tab

The [Control] tab contains settings that are used to limit or control display elements in relation to the control of the instrument's output pressure. Here, the control limits, the configuration of the stable window, the rate set point, the vent rate and the vent limits are defined.

7.3.1 Maximum and minimum limits

The [Maximum Limit] and [Minimum Limit] buttons under the Setup [] / [Control] screen provide a place to limit the set point that can be chosen in the main screen. These limits can only be set within the range of the active transducer. When the CPC8000 is in **Autorange** the limits can only be set within the range of the primary transducer which, by convention, will have the widest range. The minimum limit must be lower than the maximum limit. It cannot enter set points and thereby not control to pressures outside of these limits.

The settings are displayed in the right of the [Maximum Limit] and [Minimum Limit] buttons.



7.3.2 Stable limits

The [Stable Limits] and [Stable Delay] buttons are used in order to define a stable state for the pressure control or measurement. When the controller enters a stable condition the font colour for the pressure indication will change from white to green.

The setting is made using a numeric keypad that opens on the right-hand sidebar.

The settings are displayed in the right of the [Stable Limits] and [Stable Delay] buttons.

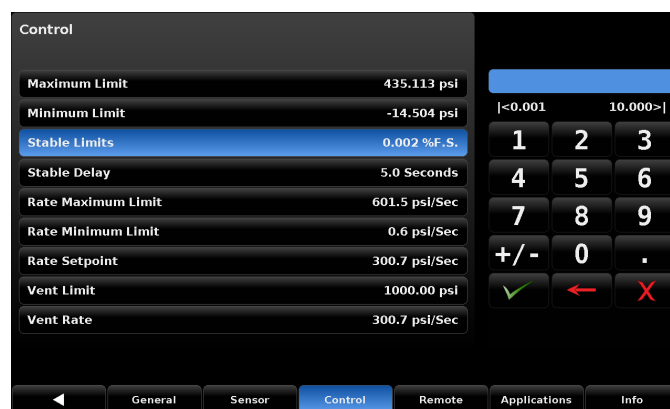

7. Basic settings

Example:

For example, an operator would like the CPC8000 to show a stable indication only after the pressure output has been at the set point $\pm 0.002\%$ FS for 2 seconds. In this case, the **[Stable Limits]** must be set to 0.002 and the **[Stable Delay]** to 2. This can be seen in the following figure.

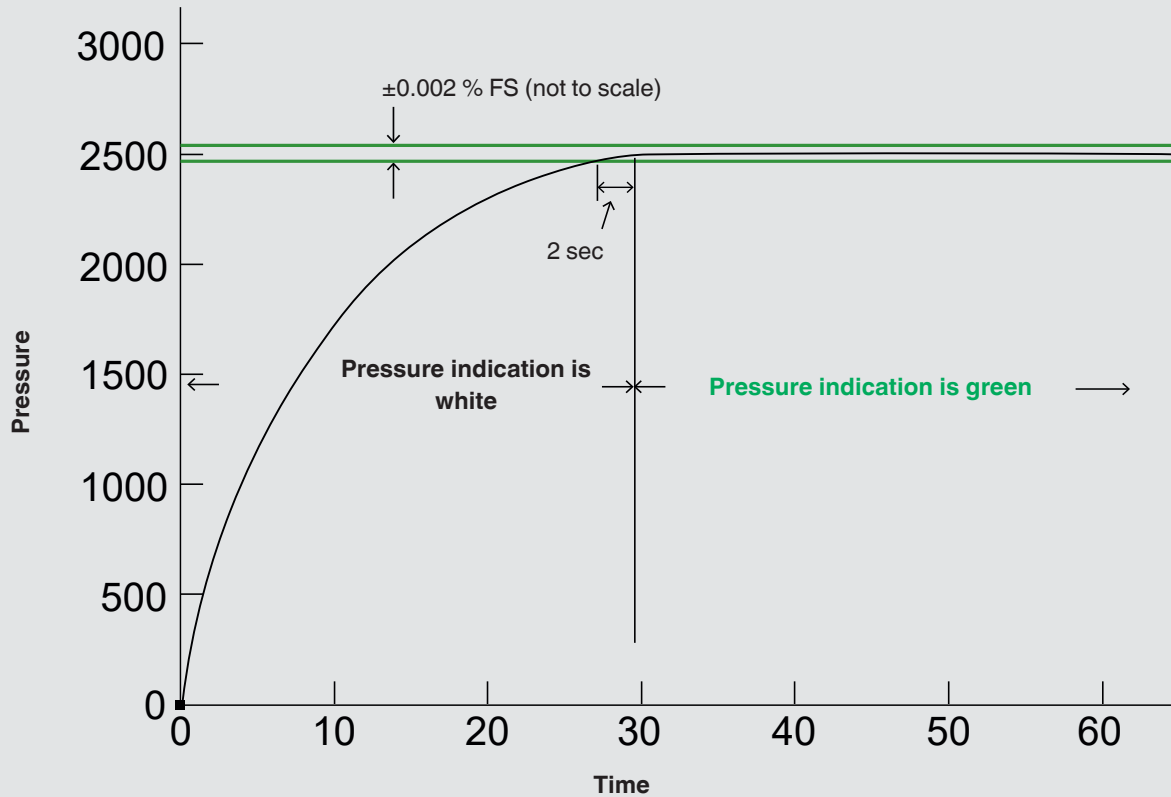



Fig. 7.3.2 – Graphical illustration

7.3.3 Rate maximum and minimum limits

Via the **[Rate Maximum Limit]** and **[Rate Minimum Limit]** buttons in **Settings** [] / **[Control]** buttons, rate value/second in the main screen can be limited. These limits can only be set within the range of the active transducer. When the CPC8000 is in **Autorange** the limits can only be set within the range of the primary transducer which, by convention, will have the widest range. The minimum limit must be lower than the maximum limit. It cannot enter set points and thereby not control to pressures outside of these limits.

The settings are displayed in the right of the **[Rate Maximum Limit]** and **[Rate Minimum Limit]** buttons.

7. Basic settings

7.3.4 Rate setpoint

The rate set point sets the rate of pressure change when the CPC8000 is controlling up or down to a set point. The rate is limited to 0.001 % of the full scale range/second to 10 % of the full scale range/second.

The rate set point is set under **Settings** [] / **[Control]** / **[Rate Setpoint]**.

The setting is made using a numeric keypad that opens on the right-hand sidebar.

The setting will be displayed in the right of the **[Rate Setpoint]** button.



7.3.5 Vent limit

The pressure value at which the controlled venting stops and the venting solenoid valve is opened, causing the pressure to be vented uncontrolled through the venting connection, is set under **[Vent Limit]**. The vent limit can be set within the values shown for the limits above the keypad.

The limit value is set under **Settings** [] / **[Control]** / **[Vent Limit]**.

The setting is made using a numeric keypad that opens on the right-hand sidebar.

The setting will be displayed in the right of the **[Vent Limit]** button.

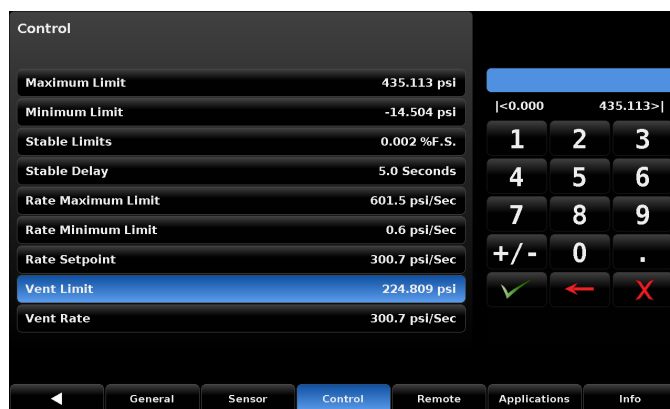

7. Basic settings

7.3.6 Vent rate

The vent rate is used to release the pressure in venting mode. The vent rate can be set within the values shown for the limits above the keypad and are relative to the full scale range of the primary transducer.

EN

The vent rate is set under **Settings** [] / [Control] / [Vent Rate].

The setting is made using a numeric keypad that opens on the right-hand sidebar.

The setting will be displayed in the right of the [Vent Rate] button.

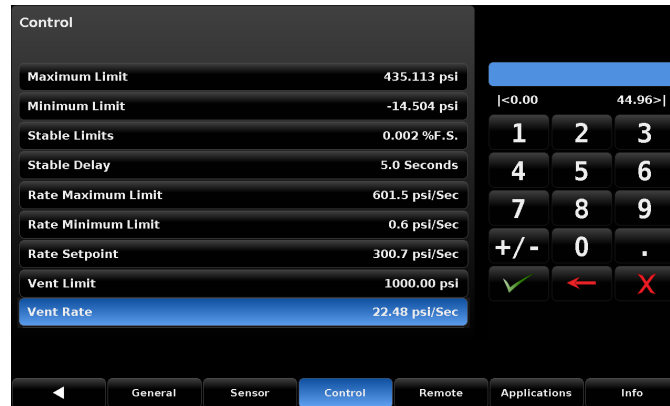

7.4 “Remote” tab

Under [Remote], the command set, which is used for the remote operation and communication with an external computer, is selected.

The following parameters can be edited:

- IEEE-488 address
- Ethernet communication settings
- Configuration of serial communication

The [Remote] view consists of two pages that can be displayed using the [▲] and [▼] [ 1 : 2 ] buttons.

→ Details about the remote operation and command sets are given in chapter 8 “Remote operation”.

→ Information about the electrical communication connection hardware is given in chapter 5.3.3 “Electrical connections and interfaces”.

7. Basic settings

7.4.1 Command set

The [Command Set] under Settings [⚙️] / [Remote] enables the selection of the command sets which are used by the remote communication software for remote control of the functions of the CPC8000.

When the [Command Set] button is chosen any of the listed command sets seen in the sidebar can be selected. This is then adopted immediately and enables the instrument to respond to commands in this command set.

The setting is displayed on the right in the [Command Set] button.

→ A list of the commands contained in each command set can be found in chapter 8 “Remote operation”.

EN

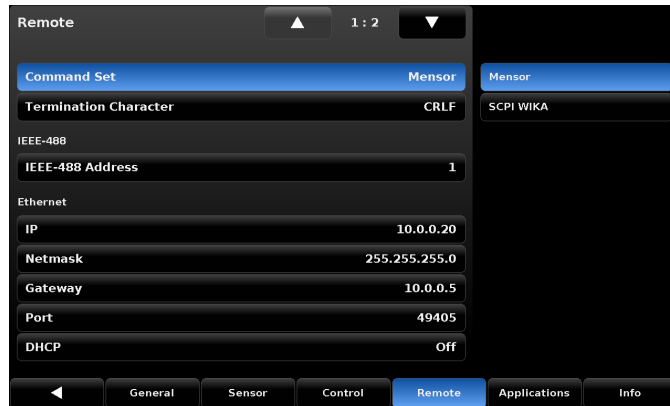

Fig. 7.4.1-A – Remote command set setup

The [Termination Character] button provides an option for to select the desired termination character in the output string of the instrument. In most cases this can be set to [Default] where the instrument automatically choses the termination character based on the selected command set.

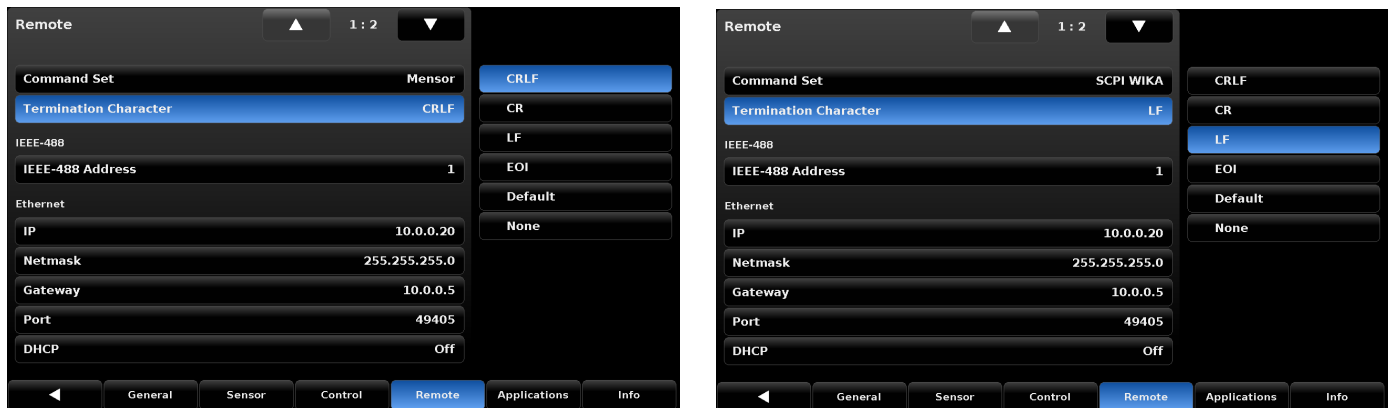



Fig. 7.4.1-B – Termination character setup

14739768.01 11/2024 en-co based on 018503001AT en-um 12/2022

7. Basic settings

7.4.2 IEEE-488 address

The [IEEE-488 Address] button within the Setup [] / [Remote] tab provides a place for the operator to set the IEEE-488 address. When the [IEEE-488 Address] button is pressed the sidebar displays the numeric keypad where an address from 1 to 31 can be entered.

The setting will be displayed in the right of the [IEEE-488 Address] button.

EN

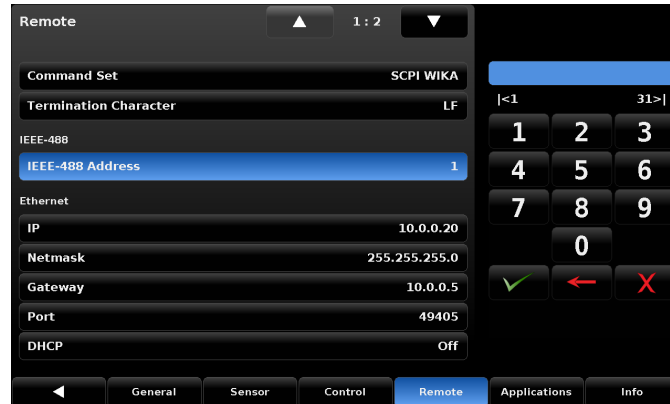

7.4.3 Ethernet settings

In the Ethernet chapter of the Setup [] / [Remote] tab there are buttons that correspond to Ethernet parameters.

The following can be set:

- IP
- Net mask
- Gateway
- Port
- DHCP

When the buttons are pressed the numeric keypad or a choice selector will be presented on the sidebar and an appropriate number or selection can be entered for the respective parameter.

- With DHCP switched off, a static IP address can be assigned.
- If DHCP is switched on and a lease is obtained successfully, the ethernet parameters are grayed and inactive but show the newly assigned lease.

If a DHCP server fails to respond, DHCP will automatically switch off. By switching off DHCP, the Ethernet parameters can be edited and a static IP address assigned.

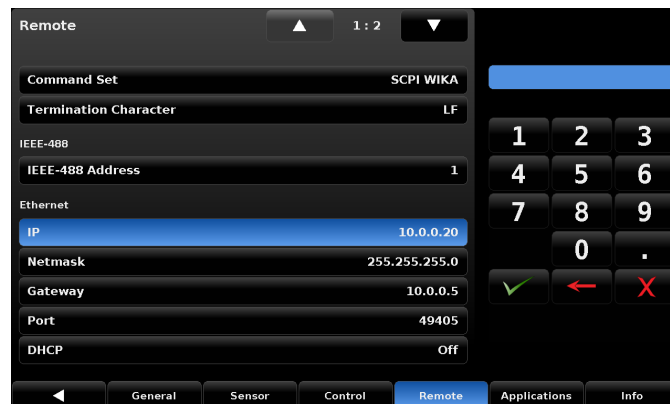

7. Basic settings

7.4.4 RS-232 settings

The “RS-232” section can be accessed under **Settings** [] / [Remote] by pressing the down arrow [▼] button on the first page of the [Remote] tab. The serial setup page has buttons that correspond to serial communication parameters.

The following parameters are provided for the RS-232 setting.

- Baud rate
- Data bits
- Stop bits
- Parity
- Echo

When a parameter button is pressed a choice selector will be presented on the sidebar and an appropriate selection can be entered for the respective parameter. These parameters should be set up to match your host computer.

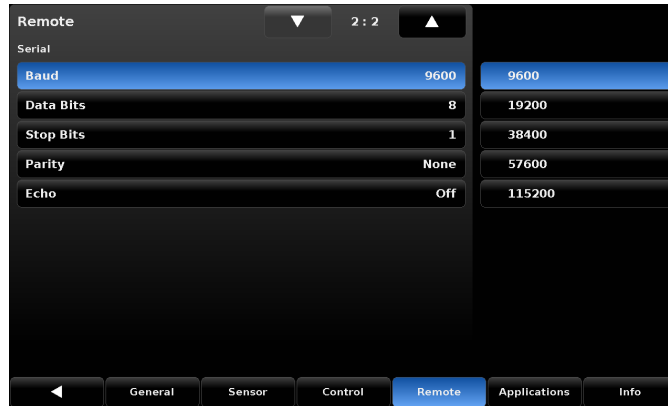

7.4.5 USB device setting

The USB device jack is a standard USB type B receptacle interface used for remote communication. The USB driver can be downloaded on the website.

7. Basic settings

7.5 “Applications” tab

Press the [Applications] tab in the Setup [] screen and a screen will appear containing various labelled symbols that when pressed access other screens that provide the following functions:

- Calibration of internal transducers
- Sequence program configuration
- Selection of favourites viewable in the main operation screen
- Setup of the digital I/O
- A troubleshooting screen that displays errors
- An adaptation screen used for performing control adaptation for the regulator
- A tune screen used for tuning the regulator and viewing controller characterisation
- An administration screen used to manage passwords
- A software screen that allows the user to upgrade instrument/regulator software

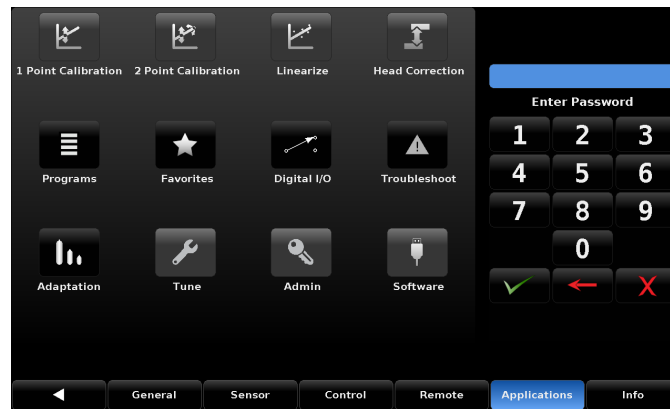

7.5.1 Passwords

All the calibration menus [1 Point Calibration], [2 Point Calibration], [Linearize] and [Head Correction] are password-protected. The “Service Password” allows access to the [Tune], [Admin] and [Software] Screens. The [Programs], [Favorites], [Digital I/O], [Troubleshoot] and [Adaptation] do not require a password.

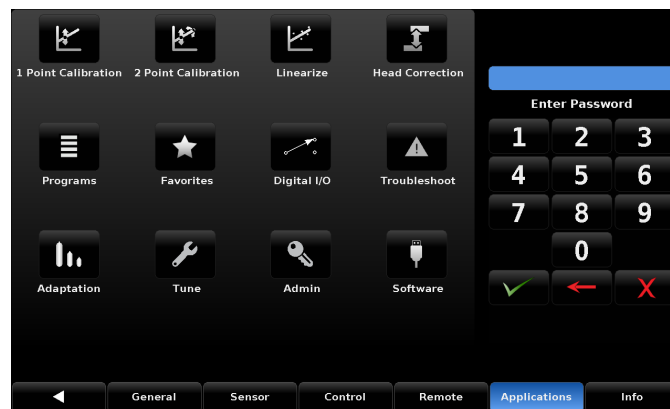



Fig. 7.5.1 – Applications tab, unlocked



The default passwords sent with the instrument are as follows:

Calibration password: 123456

Service password: 987654

Both passwords can be changed and saved in the [Admin] page within the Setup [] / [Applications] chapter. If the passwords are forgotten, contact Mensor or your local Mensor service centre for instructions to access the protected areas and to reset the passwords.

7. Basic settings

7.5.2 Calibration of internal transducers

The top row of labelled symbols in the **[Applications]** screen are the password-protected applications for calibration of the CPC8000 internal transducers. Calibration can be performed by the owner of the instrument or sent back to Mensor for a ISO-17025, A2LA accredited calibration.



Each calibration at the factory includes a comprehensive evaluation of all system parameters. During the first calibration at the Mensor factory a service file is started in which every calibration and all extra services are recorded.

This chapter is included for those who wish to calibrate their CPC8000 within their own calibration lab. Because calibration involves special training and calibration components that are not addressed here, only personnel qualified in calibration procedures should be allowed to calibrate the CPC8000.



CAUTION!

Only qualified personnel should be allowed to calibrate the CPC8000.

A Mensor recommended calibration setup is addressed in chapter 7.5.2.4 “Calibration setup”. The CPC8000 pressure reading is automatically adjusted for the effects of temperature and non-linearity within the calibrated temperature range of 15 ... 45 °C [59 ... 113 °F]. The process is referred to as dynamic compensation because each reading is adjusted before it is output to the display or to a communication bus. Thus, a calibrated CPC8000 operated within its temperature band, and with proper zero and span adjustments, will provide accurate pressure measurements.

The CPC8000 should have the calibration verified periodically to insure its stability. Initially, the recommended period between calibration is 6 months or one year, depending on the range. This period may be extended as confidence is gained in the span stability.

7.5.2.1 Calibration environment

Before performing a calibration with maximum accuracy, the following conditions should be met:

- Place the pressure controller on a stable surface
- Avoid vibrations or shocks
- Warm up the pressure controller for at least 30 minutes at an ambient temperature within the compensated range.

7.5.2.2 Calibration pressure standards

Mensor recommends the use of appropriately accurate pressure standards when calibrating this instrument. Such standards should be sufficient so that when the techniques of the ISO Guide to the Expression of Accuracy in Measurement (GUM) are applied, the instrument meets its accuracy statements as required by ISO/IEC 17025:2005, or other applicable standards.

7.5.2.3 Calibration media

Gas media are required for calibration.

Recommended:

- Dry nitrogen gas
- Clean and dry instrument air

7. Basic settings

7.5.2.4 Calibration setup

Refer to the calibration setup illustration in the following figure. It shows a typical calibration setup for absolute and gauge pressure instruments.

The **Pressure Standard** is normally a deadweight tester, a precision piston balance or a precision manometer.

The **Volume Controller** refers to a hand-operated variable-volume pressure vernier instrument. A diaphragm type vacuum gauge is recommended over the gauge tube type of vacuum transducer for calibrating sub-atmospheric pressures (shown in the illustration under “**Set for Absolute Pressure**”). A vacuum source with a capacity to generate 600 mTorr absolute is recommended.

EN

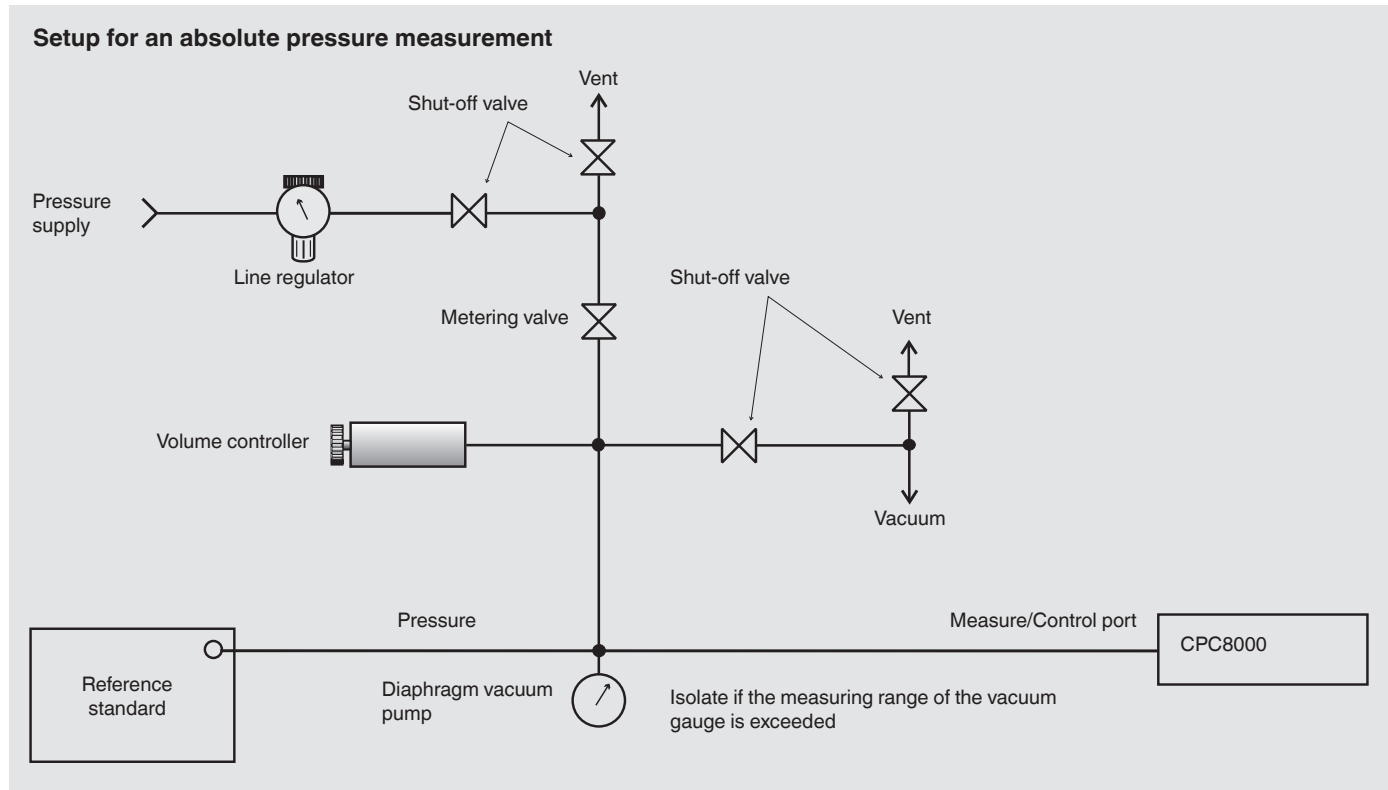

Fig. 7.5.2.4-A – Calibration setup for an absolute pressure calibration

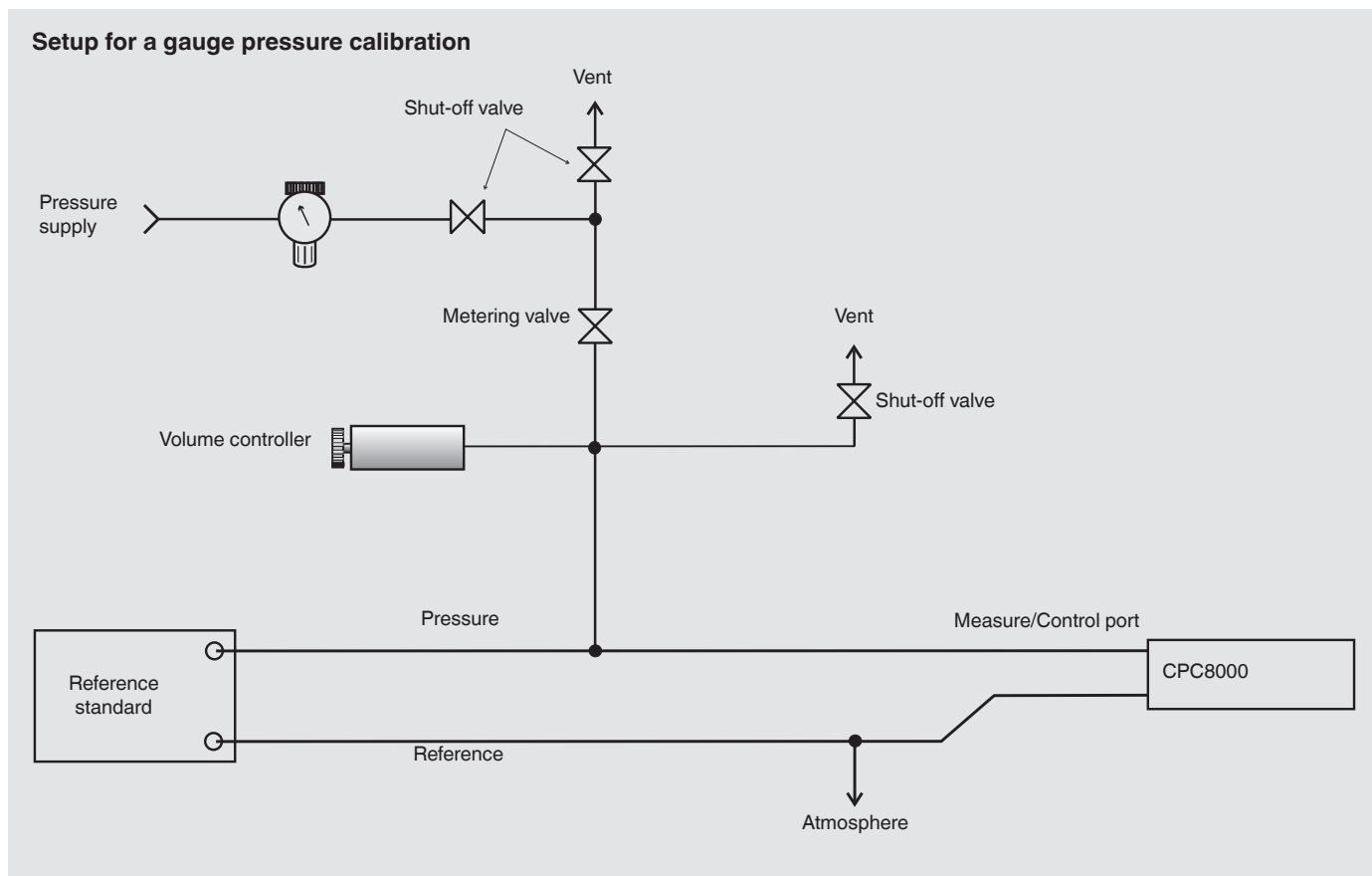

Fig. 7.5.2.4-B – Calibration setup for a gauge pressure calibration

7.5.2.5 Calibration adjustment procedure

There are three methods that can be used to calibrate all of the transducers in the CPC8000. A simple **[1 Point Calibration]** can be used to adjust a single point (usually the zero point). A **[2 Point Calibration]** extends this capability to adjust two points (usually points close to the zero and span). The **[Linearize]** calibration provides a way to calibrate and linearise the pressure curve using from 1 to 10 points over the range of each transducer. The remote zero calibration is similar to the one-point calibration but is not permanent (does not persist through power cycles).

The operation and interaction with the calibration menus can be found in the following chapters:

- For one-point calibration, see chapter 7.5.2.5.1 “One-point calibration”
- For two-point calibration, see chapter 7.5.2.5.2 “Two-point calibration”
- For linearisation, see chapter 7.5.2.5.3 “Linearize”
- For height pressure correction, see chapter 7.5.2.5.4 “Height pressure correction (password-protected)”
- For remote zero calibration, see chapter 7.5.2.5.5 “Remote zero calibration”



When calibrating the CPC8000, adjust for the difference in level between the pressure standard and the instrument (head) must be considered. See chapter 7.5.2.5.4 “Height pressure correction (password-protected)” to view and adjust the height pressure correction.

7. Basic settings

7.5.2.5.1 One-point calibration



The “**1 Point Calibration**” screen provides a place to calibrate an internal transducer or the optional barometer using a single pressure point. This is usually done to adjust the zero point of a transducer. The transducer being calibrated is chosen by pressing the **[Primary]**, **[Secondary]**, **[Tertiary]** or **[Barometer]** tab at the bottom of the screen.

With a gauge transducer, the instrument is easily vented via the **[Vent]** button. Once a stable pressure has been established, press the **[New Value]** button and a numeric keypad opens and 0 (zero) can be entered.

With an absolute transducer, the instrument should be put in **[Measure]** mode with an appropriate high accuracy reference standard connected to the Measure/Control port on the back of the CPC8000. If a sub-atmospheric zero point is required, a vacuum pump can be connected to the Measure/Control port to bring the pressure down to a value closer to absolute zero. A value of ≥ 600 mTorr is recommended. The value for the absolute pressure reading from the reference standard should be recorded by pressing the **[New Value]** button.

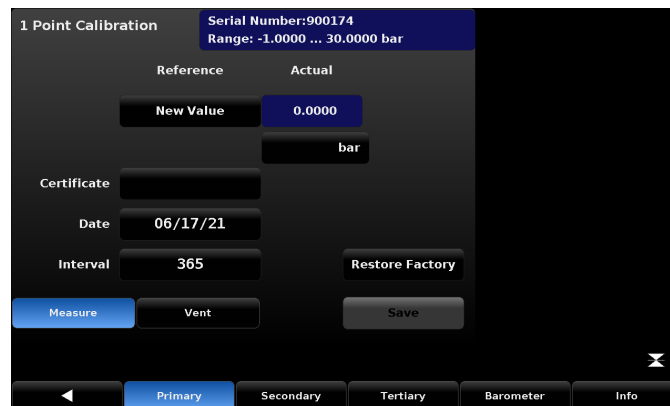

A certificate number can be entered by pressing the **[Certificate]** button. The date can be entered by pressing the **[Date]** button. The calibration interval can be viewed and changed by pressing the **[Interval]** button.

7.5.2.5.2 Two-point calibration



A two-point calibration adjusts both the **Zero** (Low Point) and the **Span** (High Point) of the active transducer. This is accomplished by interacting with the “**2 Point Calibration**” screen.

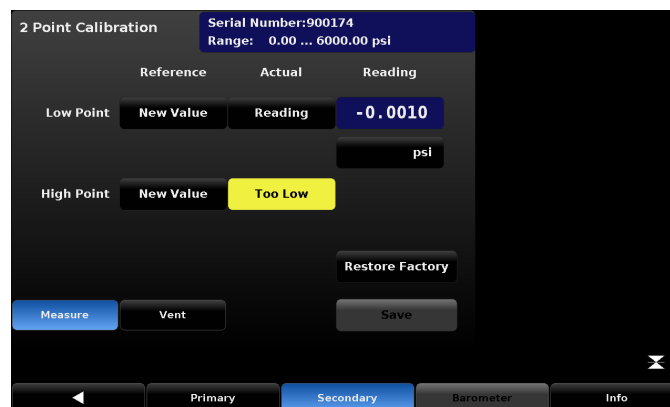

7. Basic settings

Follow the steps below for a complete two-point calibration:

1. Select the pressure transducer to be calibrated.
⇒ Available pressure transducers are displayed on the lower edge of the screen with **[Primary]**, **[Secondary]**, **[Tertiary]** or **[Barometer]**.
2. Ensure that the height pressure correction is adjusted properly, see chapter 7.5.2.5.4 “Height pressure correction (password-protected)”.

The two-point calibration screen is accessed through the password-protected portion of the **Setup** [] / **[Applications]** area. See chapter 7.5.1 “Passwords” for the default password.

To calibrate the “Low Point”:

3. The Measure/Control port of the instrument should be supplied with a suitable, minimum pressure, see chapter 5.3.2 “Pneumatic connections and pressure fittings”.
⇒ For a gauge transducer, this minimum pressure can be achieved by pressing the **[Vent]** button in the “**2 Point Calibration**” application and waiting for the reading to stabilise at, or close to, zero.
⇒ For an absolute transducer a suitable source of vacuum should be applied to the Measure/Control port along with a high accuracy vacuum standard or a pressure calibration standard should be connected to the Measure/Control port that can generate and measure a pressure value. In either case the pressure should be measured at a stable value that is a value between 600 mTorr absolute and 20 % of the selected internal transducer’s span.
4. When the pressure is stable the **[Reading]** button, under the “**Actual**” label and on the row labelled “**Low Point**”, should be pressed.
⇒ The value will be adopted and shown with a green background where the **[Reading]** button was previously.
5. Press the **[New Value]** button and, via the numeric keypad, enter the “true pressure” obtained from the calibration standard.
⇒ This value is zero (0) for a gauge transducer that has been vented. Otherwise it should be obtained from the pressure measured using the calibration standard.
6. Confirm the value with [].
⇒ The value will be adopted and shown with a green background where the **[New Value]** button was previously.
⇒ The first calibration for the low point is complete.

To calibrate the “High Point”:

The calibration of the high point is made in the same way as the low point. However, it is done in **Measure** mode.

7. Press the **[Measure]** button in the “**2 Point Calibration**” application.
⇒ The measuring mode of the instrument is activated.
8. Supply a pressure to the Measure/Control port using a pressure standard.
⇒ This pressure should be as close as possible to the full scale value of the selected transducer or at least within 20 % of that value.
⇒ The **[Too Low]** button will change to a **[Reading]** button when the pressure reaches an acceptable range.
9. After the pressure stabilises, press the **[Reading]** button.
⇒ The measured input pressure from the instrument is adopted.
⇒ The actual reading will appear within a green background where the **[Reading]** button was.
10. Press the **[New Value]** button and enter the “**true pressure**”.
⇒ This value is obtained from the pressure measured by the calibration standard.
11. Confirm the value with [].
⇒ The value will be adopted and shown with a green background where the **[New Value]** button was previously.
⇒ The second calibration for the high point is complete.
⇒ The **[Save]** button is now activated.
12. The value is saved in the transducer using the **[Save]** button.

7. Basic settings

7.5.2.5.3 Linearize



The [**Linearize**] application provides a place to record [**As Found**] calibration data and to linearise each internal transducer in the CPC8000 using that data. An “**As Found calibration**” can be performed by connecting a suitable pressure standard to the Measure/Control port, placing the instrument in [**Measure**] mode and supplying 3 to 11 pressure points across the complete range of the transducer being calibrated.

The record of the pressures generated or measured from the pressure standard and the corresponding reading from the instrument's pressure transducer can be recorded and transcribed under [**As Found**]. The screen is accessed by pressing the [**As Found**] button.

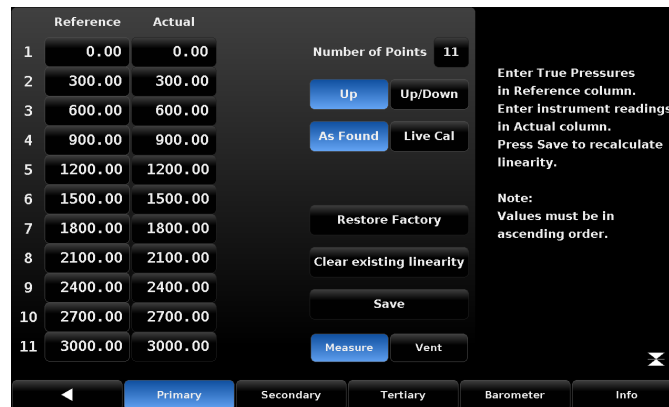

Fig. 7.5.2.5.3-A – Linearize / As Found

Linearisation with as-found calibration

1. In the [**Linearize**] / [**As Found**] view, select the transducer to be linearised via the [**Primary**], [**Secondary**], [**Tertiary**] or [**Barometer**] buttons.

Pressure test points generated by the reference standard are entered in the “**Reference**” column. The corresponding readings of the transducers are entered in the “**Actual**” column.

2. To enter recorded values, simply press the corresponding point in the “**Reference**” or “**Actual**” column.
⇒ The numeric keypad in the sidebar is displayed.
3. Enter the value via the numeric keypad and confirm with [✓].
4. Complete the **As Found calibration** with the [**Save**] button.
⇒ The internal transducer will be linearised based on the “As Found” data entered.

Linearisation with live calibration

The linearisation of the pressure transducers can also be made as a **Live Calibration**.

The **Live Cal** allows to perform the calibration and linearisation for each transducer in a more direct way. In the **Live Cal**, the reference standard is connected to the Measure/Control port and the CPC8000 is placed in measure mode.

1. In the [**Linearize**] / [**Live Cal**] view, select the transducer to be linearised via the [**Primary**], [**Secondary**], [**Tertiary**] or [**Barometer**] buttons.

The reference pressure generated by the standard is automatically recorded in the “**Reference**” column for each point. The reading of the internal transducer for each pressure point can be seen directly in the “**Reading**” window.

2. Pressing the corresponding point under the “**Actual**” column will accept that reading into that point.
⇒ Subsequent pressure points generated by the pressure standard are accepted and recorded in the same way.
3. To enter recorded values, simply press the corresponding point in the “**Reference**” or “**Actual**” column.
⇒ The keypad is displayed in the sidebar.

7. Basic settings

- Complete the **As Found** calibration with the **[Save]** button.
⇒ The internal transducer will be linearised based on the “Live Calibration” data entered.

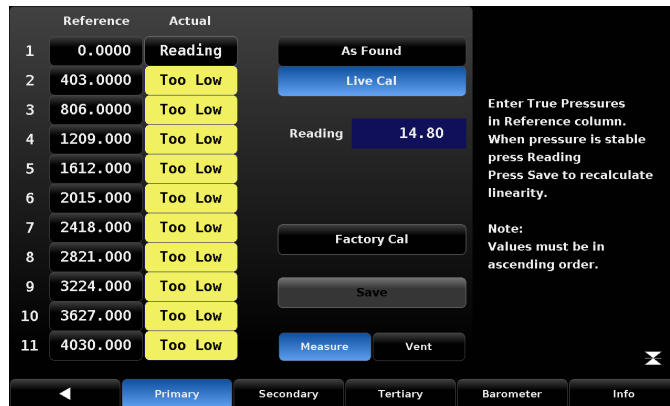

Fig. 7.5.2.5.3-B – Live Cal

At any time the **[Factory Cal]** button can be pressed to revert back to the factory calibration. The reference points and actual points can also be sent over the remote bus for automated transducer linearisations.

- Ensure first that autorange is not activated by sending “**Sensor <n>**”, where <n> is the transducer to be linearised.
- Open the “**Linearize**” menu under **Applications**.
⇒ This will automatically deactivate Autorange for the CPC8000.
- Set each reference pressure with the command “**Desiredpress <n>,<pressure>**” where <n> is the 0th based index.
- “**Desiredpress 0,0**” will set the first reference point’s value to 0.
- “**Desiredpress 1,1.5**” will set the 2nd reference point to 1.5, etc.

Each subsequent reference point must be greater in value than the previous point.

Recommendation:

Send all reference points before continuing.

- Use a reference (e.g. CPB6000) to control the pressure on the measure port to the reference/desired pressure.
- Then send the pressure reading over the bus with the command “**Actualpress <n>,<reading>**” where <n> is the 0th based index.

This reading should be within +/- 1 % FS of the reference point. See fig. 7.5.2.5.3-A as an example: If “**Desiredpress 3,1209.0**” was sent, “**Actualpress 3,<reading>**” is then sent, where <reading> must be between 1168.70 and 1249.30.

- Send each of the 11 readings with the “**Actualpress**” command.
- Then send “**Calculate_as_found_linearity**” and then “**Save_linearity**”.
⇒ The linearisation of the active transducer is now complete.

7. Basic settings

7.5.2.5.4 Height pressure correction (password-protected)



The **Setup** [] / [**Applications**] / [**Head Correction**] screen is the place to enter parameters that affect the offset that occurs when the instrument is being calibrated and located at a different level (elevation) compared to the transducer inside of the CPC8000. Touching any of the active buttons in this screen will activate the numeric keypad.

Each of the four rows represent a different parameter in the height pressure correction calculation. In the “**Height (INST-DUT)**” line, the height of the **device under test (DUT)** is subtracted from the reference point of the **instrument (INST)** and entered. The gas temperature and local gravity used in the calibration system must be entered in the following fields. The default height is zero (0) indicating that there is no height pressure correction applied. English or metric units can be chosen by pressing the corresponding button.

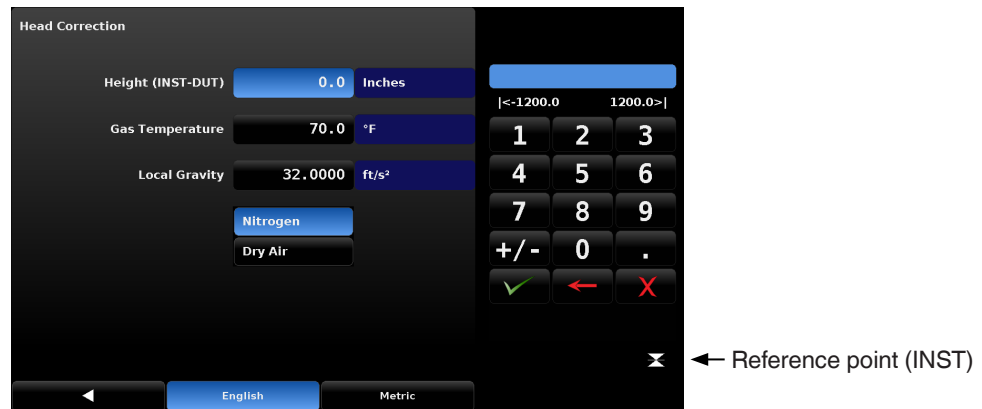

7.5.2.5.5 Remote zero calibration

There are two types of zeros that may be applied. The first type is a zero that applies to the transducer and the second type is a zero that applies only when the transducer is in an emulated pressure mode (e.g. absolute emulation with a native gauge, or gauge emulation with a native absolute).

The zero point from the emulation mode is not saved in the transducer. It is deactivated as soon as you switch to native mode and reactivated when you switch to emulation mode. This way, an absolute transducer may be zeroed in gauge emulation without it affecting the absolute mode's reading.

Clearing the emulation zero, by sending “**ZERO ?**” when in emulation mode, does not reset the native zero.

Clearing the native zero, by sending “**ZERO ?**” when in native mode, clears both the native and the emulation zero. Typically it is used to set a daily zero as barometric pressure changes but can be used to correct at any measured value.

There are several commands that can set the zero for the transducers.

In the Mensor command set they are “**ZERO**” and “**AUTOZERO**” and require “**CALDISABLE**” to be switched off.

In the SCPI command set they are “**CAL:PRES[R]:ZERO**” and “**CAL:ZERO:RUN**”: **CALDISABLE** must not be switched off.

“**ZERO**” will set the zero for the currently active transducer. It is advised to be in vent mode and at atmospheric ambient pressure.

“**CAL:PRES[R]:ZERO**” works the same as “**ZERO**” except you can specify which transducer you wish to zero. If transducer 1 is active, the protection solenoid valves for transducers 2 and 3 (if present) are enabled. This means there could be trapped air between the solenoid and transducer that could be different than ambient atmosphere pressure, even if vented. When specifying the transducer with “**CAL:PRES[R]:ZERO**”, it is advised to be in autorange and vent mode, or to have the target transducer active and in vent mode.

“**AUTOZERO**” places the instrument in vent, sets the range to autorange if there is more than one transducer present and waits for the pressure reading to become stable. If the pressure reading is not stable within 180 seconds, an error will be generated and the autozero sequence will abort. The autozero routine then sets the zero to 0 for each transducer present.

7. Basic settings

The autozero routine will return the instrument to the initial configuration (active transducer/autorange and measure type) when complete. “**CAL:ZERO:RUN**” functions like “**AUTOZERO**”, only that **CALDISABLE** must not be switched off.

The zero point can only be set with native gauge transducers or absolute transducers with barometer through **AUTOZERO/CAL:ZERO:RUN**.

When zeroing, the screen is locked so that the configuration of the instrument cannot be changed. After the zeroing is complete, **KEYLOCK** is returned to its pre-zeroing state. If the zero points of several transducers are set using the “**ZERO**” or “**CAL:PRES:ZERO**” commands, you must wait approx. 10 seconds between the individual zero point setting commands so that the previous process can be completed. The zero offset can be queried with “**ZERO?/CAL:PRES[R]:ZERO?**” and cleared with “**ZERO**”.

There is not a SCPI command to clear the zero.

7.5.3 Programs



The **Setup** [] / **[Applications]** / **[Programs]** screen is used to create, view and edit programs that are used to automatically run a sequence of commands within the CPC8000. There are two tabs at the bottom of the “**Program**” screen. The “**Display**” tab provides a place to view each program or add a new one. The program can be edited via the “**Edit**” tab.

Pressing the program label (program selection button) at the top left will allow selection of predefined programs from the sidebar plus a set of blank labels where new programs can be entered.

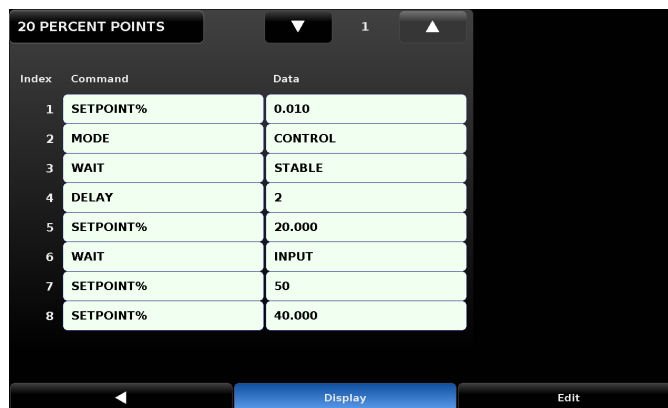

Index	Command	Data
1	SETPOINT%	0.010
2	MODE	CONTROL
3	WAIT	STABLE
4	DELAY	2
5	SETPOINT%	20.000
6	WAIT	INPUT
7	SETPOINT%	50
8	SETPOINT%	40.000

Fig. 7.5.3-A – Programs

With the **[Edit]** tab selected, see fig. 7.5.3-B, it can edit existing programs or create steps in new ones. Pressing a “**Command**” or “**Data**” will present the available commands, or a data entry selections in the sidebar. The **[Insert]** and **[Delete]** buttons allow insertion and deletion of lines.

Selection of commands and data in each sequential line will create a draft of the resulting command sequence in the selected program.

After exiting the editing with the [**◀**] button, “**Replace old values?**” is displayed.

- ▶ Pressing the [**✓**] will accept the changes.
- ▶ Pressing the [**X**] will revert back to the old program.

7. Basic settings

A list of available commands, data values and their functions are listed in the table.

EN

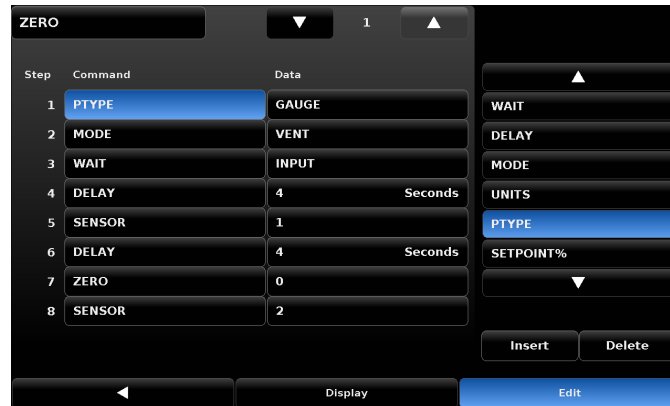



Fig. 7.5.3-B – Edit programs

Command	Function (data selection)
DELAY	Delays for time = 1 to 3,600 seconds (numeric entry)
LOOP	Loops back to a selected line for a selected number of iterations (numeric entry)
MODE	Sets the control mode (measure, control or vent)
PTYPE	Sets the pressure type (gauge or absolute)
RSETPT	Sets the rate set point in current units (numeric entry)
RUNITS	Sets the rate denominator time unit (min or sec)
SENSOR	Sets the active transducer (1, 2 or 3)
SEQSTART	Starts the sequence from the beginning (none)
SETPOINT	Sets the control set point for the instrument (numeric entry)
SETPOINT%	Sets the control set point in % of current range (numeric entry)
WAIT	Waits for a manual input or stable condition (stable or input)
ZERO	Zeros active transducer (none)

7. Basic settings

7.5.4 Favourites



The Setup [] / [Applications] / [Favorites] screen is used to select programs that will appear in the main screen when the Favorites [] symbol is pressed. The current favourites list is displayed on the left-hand side. Other possible programs are displayed on the right-hand sidebar. The program is added to the favourites by pressing a button in the right-hand sidebar.

EN

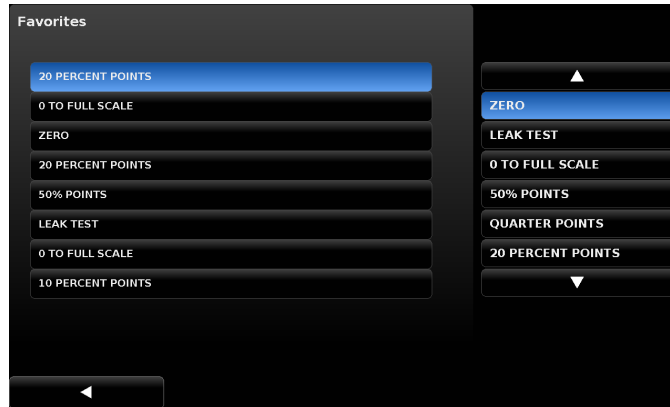

7.5.5 Digital I/O



Under Settings [] / [Applications] / [Digital I/O], the digital input and output conditions or actions are assigned. In the standard view, all inputs and outputs are deactivated.

7.5.5.1 Digital inputs

As shown in fig. 7.5.5-A, the digital inputs [Input 1], [Input 2] and [Input 3] are assigned the operating modes [Measure], [Control] and [Vent]. When a digital signal (switch closure) is sent to the “1”, “2”, or “3” input terminal on the back panel of the instrument the instrument mode will change to “Measure”, “Control” or “Vent”. Each input can be assigned to one of the choices listed on the right by pressing the input then the choice. The [Keylock] button will lock out the touchscreen interface preventing local operation and [Start] will start the most recent program selected in favourites [] menu.

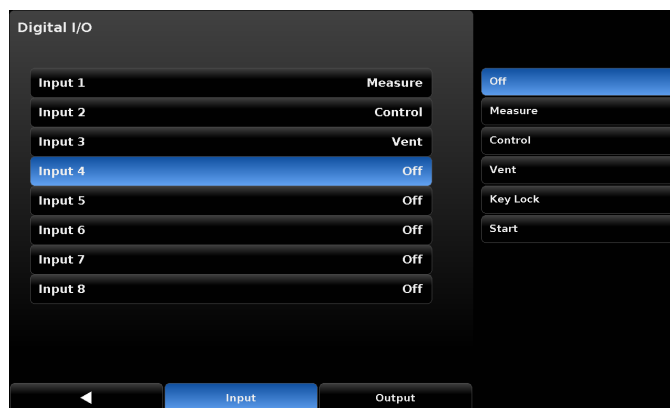

Fig. 7.5.5-A – Digital input

7. Basic settings

7.5.5.2 Digital outputs

In fig. 7.5.5-B [Output 1] is assigned to the **Vent** mode of the instrument. Output 1 will be energised when the CPC8000 is in **Vent** mode. Each output can be assigned to one of the choices listed on the right by pressing the output and then the choice. Each output switch will be energised when the assigned instrument mode is active. When the mode is inactive the assigned output switch will be de-energised.

The **[Pump]** choice indicates that the controller requires a vacuum pump to be on in order to control to a sub-atmospheric pressure. The pump output is used to switch on or off a vacuum pump as needed.

→ See chapter 5.3.3 “Electrical connections and interfaces” for pinout description.

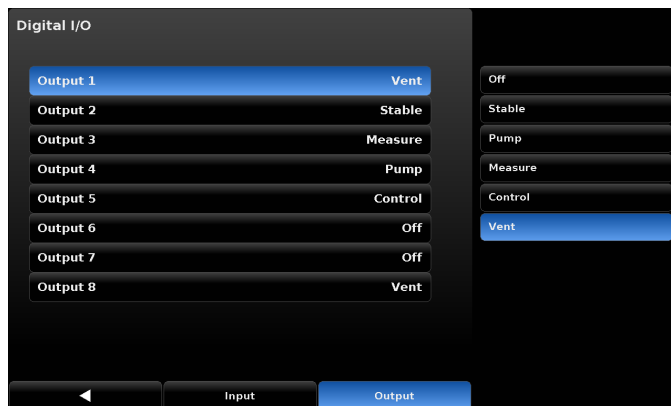

Fig. 7.5.5-B – Digital output

7.5.6 Troubleshoot



Under **Settings** [⚙️] / **[Applications]** / **[Troubleshoot]**, a list of the internal or remote errors that may have occurred is provided.

All errors are listed in the **[Error]** tab.

In the **[Remote]** tab, errors that were sent or received via one of the remote communication connections are displayed. This, in turn, is helpful for debugging software programs that are used for remote operation.

Once the errors have been viewed in this screen, they are cleared.

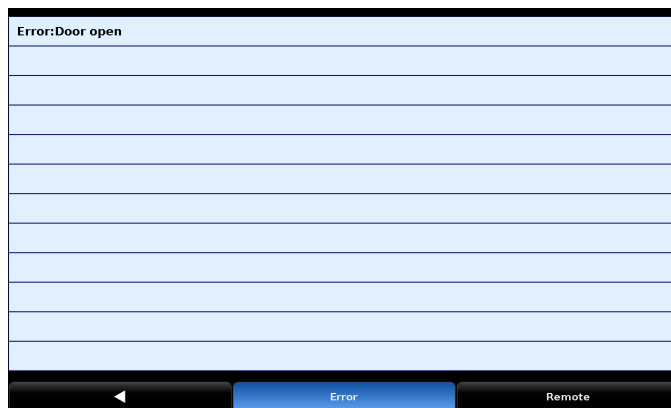

7. Basic settings

7.5.7 Adaptation



The [Applications] / [Adaptation] screen allows configuration of the CPC8000 to deliver best performance in different conditions like changes in supply pressure, control volume and reference transducers. The adaptation chapter consists of two screens; **Adaptation** and **Configuration**.

EN

The **Adaptation** allows the user to set up parameters for running the adaptation test. The **Configuration** screen allows saving and loading each unique configuration to the regulator.

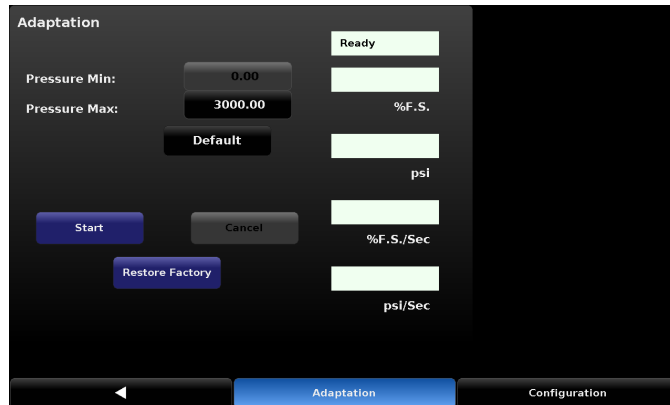

Fig. 7.5.7-A – “Control adaptation” screen

Mode	Function
Pressure Min: (minimum pressure)	The minimum pressure the needle valve regulator (NVR) will be characterised for. This value may not be changed.
Pressure Max: (maximum pressure)	The maximum pressure the NVR will be characterised for. This value must be set to 10 % below the supply pressure connected to the supply port of the instrument.

The value is entered using the numeric keypad on the right-hand sidebar.



Fig. 7.5.7-B – Pressure max. entry



NOTE

The maximum pressure should not be set lower than 50 % of the maximum pressure range of the primary transducer.

14739768.01 11/2024 en-co based on 018503001AT en-um 12/2022

7. Basic settings



NOTE

The control upper limit will be updated to match the pressure max value. After characterizing an NVR for a certain range, the control upper limit should not be set higher than this amount.

EN

Mode	Function
Gain Inlet Position	Supply needle valve position during the adaptation test. Setting this value higher will make the test take less time, as the valve will be opened more. Setting this value lower will close the valve more during the test, causing the flow rate through the valve to be less and may allow for a better characterization of the valve, and better performance.
Gain Outlet Position	Exhaust needle valve position during the adaptation test. Setting this value lower (more negative) will make the test take less time, as the valve will be opened more. Setting this value lower will close the valve more during the test, causing the flow rate through the valve to be less and may allow for a better characterization of the valve, and better performance.
Default	Loads default values for Pressure Min., Pressure Max., Gain Inlet Position and Gain Outlet Position based on factory settings and the maximum range of the primary transducer installed.
Start	Performs the control adaptation test, changing the pressure in the instrument from the pressure minimum to the pressure maximum, then back down to the pressure minimum. Upon successful completion, the status box will display "Complete".
Cancel	Performs a controlled vent back to atmospheric pressure and stops the control adaptation test.
Restore factory	Loads all of the factory settings back into the instrument.



CAUTION

If an emergency vent of the system is required for any reason, press the power button and switch off the instrument.

The status of the adaptation test can be observed in the top left area of the **[Adaptation]** screen.

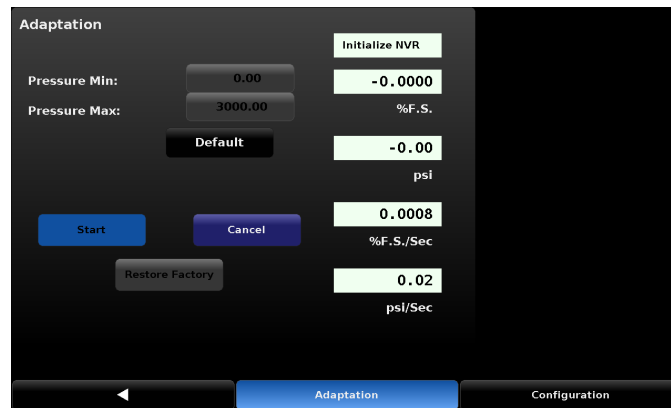

Fig. 7.5.7-C – Adaptation test status

7. Basic settings

The **[Configurations]** button at the bottom right allows access to the Configuration screen. The configuration screen stores eight adaptation tests within the CPC8000 for easy access in the event of change in operating conditions. By default all the configurations are set to factory settings.

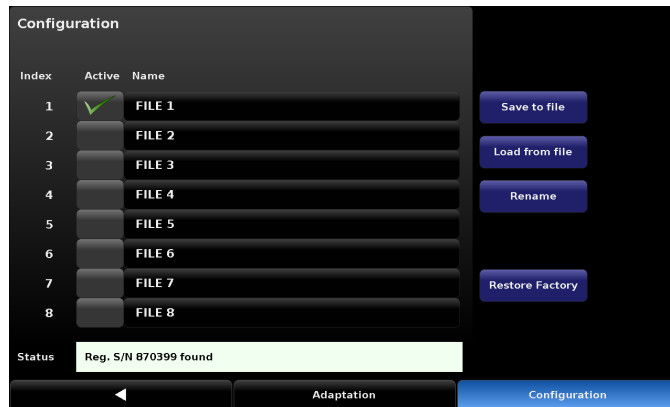

Fig. 7.5.7-D – Configuration screen

1. To rename a configuration file, press the button with the name of the file.
⇒ File is activated.
2. Press the **[Rename]** button.
⇒ An alphanumeric keyboard will be displayed.
3. Enter the desired name and confirm with [✓].
⇒ The status of the process is shown in the status bar at the bottom of the screen, here **“Renamed file #1”**.
⇒ In the **“Active”** column, a green arrow is displayed.
4. Return to configuration menu with [◀].

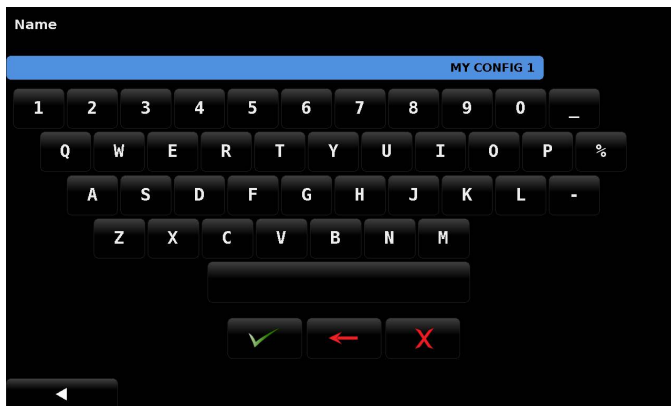

Fig. 7.5.7-E – QWERTY keyboard

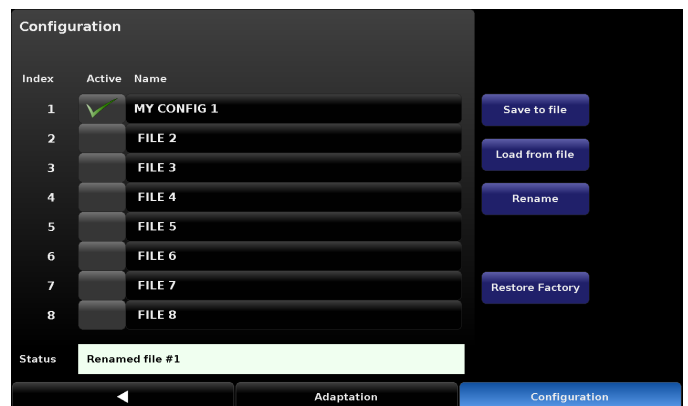

Fig. 7.5.7-F – Renamed file

7. Basic settings

1. To load a current adaptation test profile into a configuration file, select this configuration file.
 2. Confirm with [✓].
 3. Press the [Save to file] button.
 - ⇒ The status of the process is shown in the status bar at the bottom of the screen, here “Saved to file #2”.
 - ⇒ In the “Active” column, a green arrow is displayed.
 4. Return to configuration menu with [◀].
-
1. To activate a previously saved adaptation test profile, press the desired file name.
 2. Press the [Load from file] button.
 - ⇒ The status of the process is shown in the status bar at the bottom of the screen, here “Loaded from file #1”.
 - ⇒ In the “Active” column, a green arrow is displayed.
 3. Return to configuration menu with [◀].



Fig. 7.5.7-G – Save file

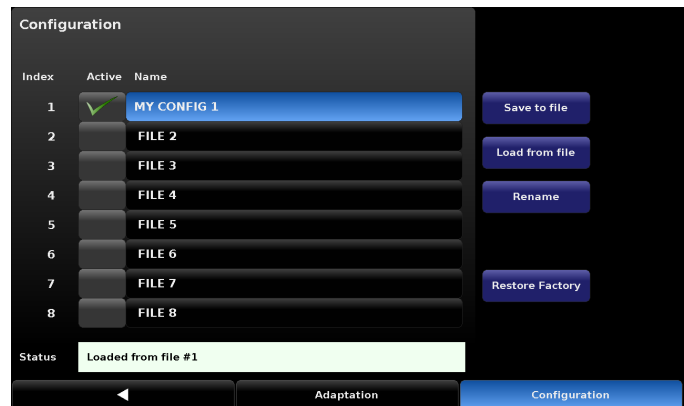

Fig. 7.5.7-H – Load file

7. Basic settings

7.6 Service menu

7.6.1 Tune



The tune screen is password-protected. It can be accessed with the service password, see chapter 7.5.1 "Passwords".



The **Settings** [] / **[Applications]** / **[Adaptation]** and also the **[Seal Point]**, **[Characterize]**, **[Linearity Graphs]** and **[Gain Test]** tabs should only be used with close supervision from Mensor customer service. Changing parameters within this chapter will change the regulator response and may cause the CPC8000 to fail to meet control specifications or output pressure that could damage externally connected instruments.

EN

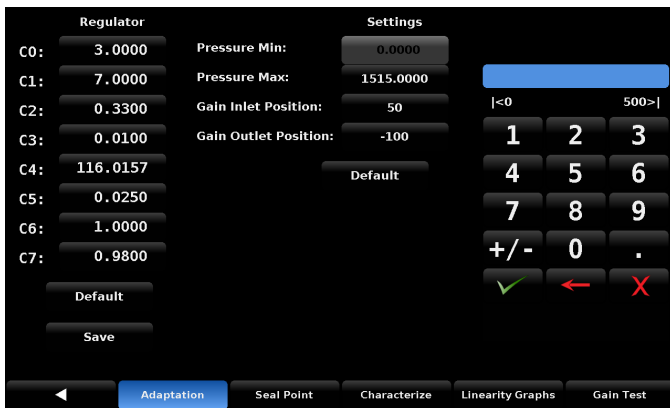

Fig. 7.6.1-A – Adaptation

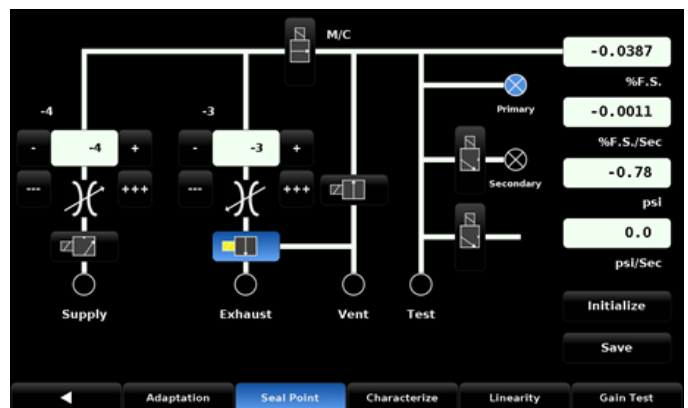

Fig. 7.6.1-B – Seal point



Fig. 7.6.1-C – Characterize

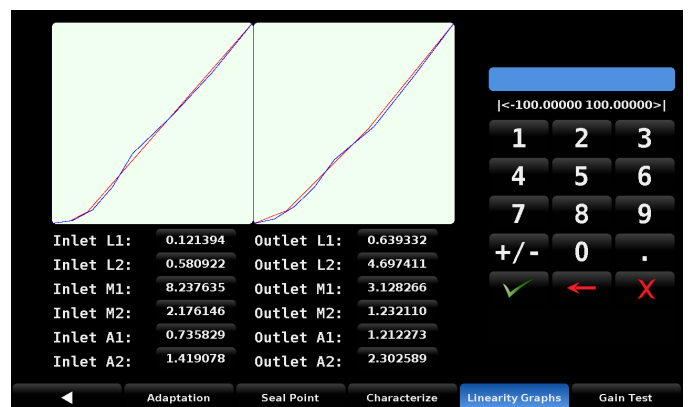

Fig. 7.6.1-D – Linearity graph

7. Basic settings

EN

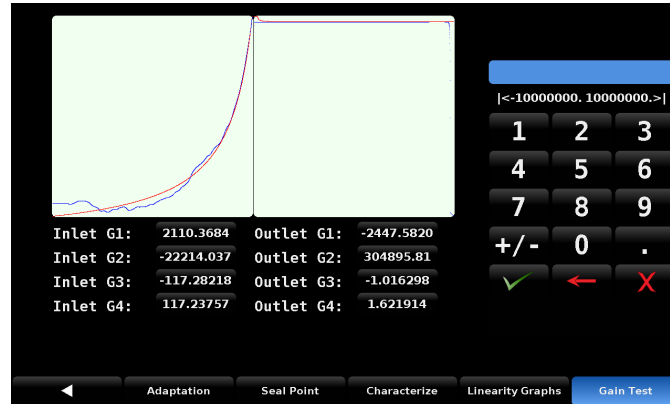



Fig. 7.6.1-E – Gain test

7.6.2 Admin



The **Setup** [] [Applications] [Admin] screen has a place to change the calibration and service passwords and save configurations.

Change password

1. Press the [Change Password ... Calibrate] button.
⇒ It opens a numeric keypad.
2. Enter new password and confirm with [].
⇒ The same procedure applies to the [Change Password ... Service] button.

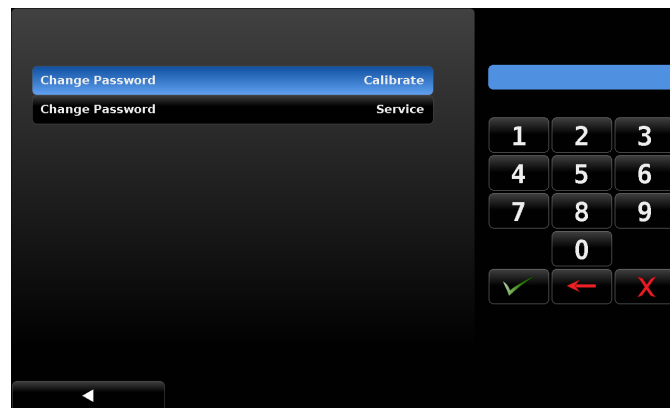

7. Basic settings

7.6.3 Software upgrade



Choose the **Software application** [] when upgrading instrument software from a USB drive.

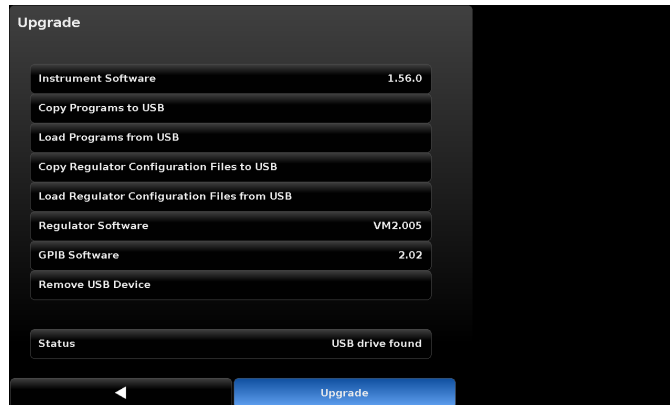

EN

Mode	Function
Instrument Software	Displays the current software on the controller. If a USB drive has been inserted into the port on the front or rear, it can be selected using this button. It will show you the available software versions that are on the USB drive.
Copy Programs to USB	This button will copy the programs from the CPC8000 programs application to the USB drive and store them in the root directory in a folder named "seq." Each program will be stored within that folder as a .txt file.
Load Programs from USB	This button will load the programs that are stored on the USB drive to the CPC8000 and overwrite any current programs that are on the instrument.
Copy Regulator Configuration Files to USB	This button is used to save the regulator settings from the CPC8000 to the USB drive.
Load Regulator Configuration Files from USB	This button is used to load regulator settings saved on the USB drive into the CPC8000 and overwrite the settings currently saved in the instrument.
Regulator Software	This will display the current version of the regulator software. When selected, a list of regulator versions will be available for installation if they are on the USB drive.
Remove USB Device	This will safely unmount the USB drive.
Status	Displays whether or not a USB drive is available.

7. Basic settings

7.7 “Info” tab

The contact details of Mensor, the serial number of the instrument, the firmware version, a list of the integrated transducers and other information are displayed here.

You can access the display via **Settings** [] / **[Info]**.

EN



8. Remote operation

8. Remote operation

8.1 Software and functions

When the instrument is switched on it takes about 30 seconds to complete the initialisation. The BIOS tests the system CPU board, then the operating system. The system will go through software and hardware initialisation. The following hardware/software is initialised:

Transducers

The system is scanned for installed transducers and all operating transducers are initialised. The transducer(s) RAM data is transferred to system RAM where appropriate.

- GPIB: The GPIB board is initialised as a talker/listener.
- Units: The scale factors for percent full scale and counts are calculated.
- Serial: The external serial port is initialised.
- Valves: The pressure control algorithm is initialised.
- Options: Any optional hardware/software is initialised.
- Interrupts: Interrupt vectors are loaded and enabled.

After initialisation, the program enters a polled loop.

The proprietary calibration constants and current settings are stored in a non-volatile instrument.

8.2 Remote command set

This remote command set is the default set available on the CPC8000. All commands must be terminated with a "Carriage Return" (<CR>), "Line Feed" (<LF>), or both.

For queries (ending with a ?), the data column represents the response of the CPC8000. All response strings begin with a space character or an "E" representing that there is an error in the error queue. All response strings are terminated with a <CR> and a <LF>. The error queue holds the last 10 errors identified.

For all commands (no ?), the data column represents the required parameters to be sent to the CPC8000 following the string in the command column. For any command that requires multiple parameters to be sent, the parameters must be separated by commas.

Output formats

Pressure readings are returned in exponential notation in a format according to the OUTFORM command as follows.

1. <sp> pressure value <cr><lf>
2. <sp> pressure, units, mode <cr><lf>
3. <sp> pressure, pressure rate <cr><lf>
4. <sp> pressure, minimum peak, maximum peak <cr><lf>
5. <sp> pressure, active sensor (P or S) active turndown (1-2) <cr><lf>
6. <sp> pressure, control point, stable or slewing <cr><lf>
7. <sp> pressure, no barometer or baro reading <cr><lf>

8. Remote operation

8.3 Mensor command set

Command	Data	Response/Function
?	→ See chapter 8.2 "Remote command set"	Returns data per the current output format.
Absolute?	<sp>(YES or NO)<cr><lf>	Returns if the primary transducer is native absolute
Acquire?	15 char string. Ex: Acquire? Test_stand_1 Returns: <sp>(YES or NO), CCC...CCC<cr><lf>	This command is used when multiple computers would like to control the instrument. YES if acquisition is successful. NO if instrument is being controlled with another computer. CCC...= name of controlling computer → See ' Release? ' and ' Unlock '
Actualpress	<n>,<f>	Used for a linearity calibration fix. Sets the internal transducer pressure for segment n. The value in segment n must be between the values of segments n-1 and n+1. End points must be within 1 % of the minimum and maximum of the range's span. → See ' Calculate_as_found_linearity '
Actualpress? <sp><n>	<sp>n.nnnnnE+nn<cr><lf>	Returns the actual transducer pressure for the specified segment n.
Address	1-31	Sets the GPIB address.
Address?	<sp>nn<cr><lf>	Returns the GPIB address.
All?	<sp>+n.nnnnnE+nn,..., +n.nnnnnE+nn <cr><lf>	Returns pressure readings of all transducers on the active channel, including the barometer.
Asset_tag	16 char string	General purpose string for customer use.
Asset_tag?	<sp>ssssssssssssssss<cr><lf>	Return customer asset tag string.
Autorange	ON or OFF	Sets whether the autorange function is enabled or disabled.
Autorange?	<sp>(ON or OFF)<cr><lf>	Returns whether the autorange function is enabled or disabled.
Autozero	none	Re-zero all the ranges on the active channel. These adjustments are not password-protected and are saved permanently through power cycles while the instrument is in native mode (temporary while in emulation mode). This command takes approximately 60 seconds but may take longer depending on the time to become stable.
Autozero?	<sp>S,T,X,X<cr><lf>	Returns autozero data where S represents state (0 = complete, 1 = local autozero, 2 = remote autozero) T represents the estimated time to complete in seconds, and x is a (0) character since this data location is not used at this time.
Autozeroabort	none	Aborts autozero. Any transducers that have been zeroed will not revert to previous zero point offsets.
Baro?	<sp>+n.nnnnnE+nn<cr><lf>	Returns reading from barometric transducer or " NO BAROMETER " if one isn't installed.
Baroid?	<sp>Mensor,SN XXXXXX, VN.NN<cr><lf>	Returns identification string for the barometer.
Barocaldisable	YES, NO	Not used, kept for backward compatibility.
Barocaldisable?	<sp>(YES or NO)<cr><lf>	Not used, kept for backward compatibility.
Barounits	→ See units code or text in chapter 14.4 "Conversion factors, millitorr"	Sets the barometer pressure units. Note: This only effects the displayed output on the screen, not any remote responses.
Barounits?	<sp>CCCC<cr><lf>	Returns the barometer units in a text string.
Brightness	0-100	Set the brightness of the screen from 0 to 100 %.
Brightness?	<sp>nn<cr><lf>	Get the brightness of the screen.

EN

8. Remote operation

EN

Command	Data	Response/Function
Calculate_as_found_linearity		Calculate linearity slopes and intercepts from true/actual pressures and loads the linearity correction coefficients to the transducer. → See ' ActualPress ' and ' TruePress '.
Caldisable	YES, NO	Sets whether or not calibration of the active transducer is disabled.
Caldisable?	<sp>(YES or NO)<cr><lf>	Returns whether or not calibration of the active transducer is disabled.
Cerr	None	Clears the error queue.
Chanfunc	Press, peak, rate, rate setpt, dio, units	Sets the secondary display function mode, works identical to Chanfunc2 (kept for backward compatibility).
Chanfunc?	<sp>CCCC...<cr><lf>	Returns the secondary alternate function mode, works identical to Chanfunc2 (kept for backward compatibility).
Chanfunc2	Press, peak rate, rate setpt, dio, units	Sets the secondary display function mode.
Chanfunc2?	<sp>CCCC...<cr><lf>	Returns the secondary alternate function mode.
Chanfunc3	Press, peak rate, rate setpt, dio, units	Sets the tertiary display function mode.
Chanfunc3?	<sp>CCCC...<cr><lf>	Returns the tertiary alternate function mode.
Cmdset	Mensor, SCPI	Activates remote command set for instrument emulation modes.
Cmdset?	<sp><CCCCC><cr><lf>	Returns active command set identifier.
Control		Instrument placed in control mode.
Control?	<sp>(YES or NO)<cr><lf>	Returns YES if instrument is in control. NO if otherwise.
Crate	Slow, medium, fast, variable	Sets the control rate, variable mode is a predetermined user-defined rate setpt.
Crate?	<sp>CCCCC<cr><lf>	Returns the control rate – CCCC is variable in length and corresponds to the parameters for the ' CRATE ' command.
Ctype?		Returns the type of regulator.
Decpt?	<sp>n<cr><lf>	Returns the number of decimal points. → See ' Resolution '
Default	None	Sets the default values.
DHCP	ON or OFF	If no DHCP server is found when DHCP is switched on, DHCP will be switched off.
DHCP?	<sp>(YES or NO)<cr><lf>	Returns current status of DHCP.
DIO	2 or 0	2 turns on the first digital output pin, 0 turns it off.
DIO?	<sp>n<cr><lf>	Returns status of the first input and output pin. Bit0 = input's status, Bit1 = output's status.
DIOSTATE?	<sp><n><cr><lf>	Bit 0 ... 7 is the status of the input bits. Bit 8 ... 15 are the status of the output bits. Returns an integer between 0 and 65536.
DINFUNC	<n>,<CCCCC><cr><lf>	Sets the function for input pin <n> to NONE, READING, MEASURE, CONTROL, VENT, KEYLOCK, START .
DINFUNC? <n>	<sp><CCCCC><cr><lf>	Returns the function for output pin <n>.
DOC	mm/dd/yyyy	Sets the date of calibration for the active transducer.
DOC?	<sp>mm/dd/yyyy<cr><lf>	Returns the date of calibration for the active transducer.
DOM?	<sp>mm/dd/yyyy<cr><lf>	Returns the date of manufacture.
DOUFUNC	<n>,<CCCCC><cr><lf>	Sets the function for output pin <n> to NONE, STABLE, PUMP, MEASURE, CONTROL, VENT , pump control only.
DOUFUNC? <n>	<sp><CCCCC><cr><lf>	Returns the function for output pin <n>.

8. Remote operation

EN

Command	Data	Response/Function
DOUTSTATE	<n><sp><HIGH/LOW/1/0>	Turns output pin <n> to high, or low. Sets the function for that pin to "NONE".
Error?	<sp> text description <cr><lf>	Returns the next error in the error queue.
Errorno?	<sp>Enn-text<cr><lf>	Returns pcs400 error code and text.
Filter	OFF, LOW, NORMAL, HIGH	Sets the reading filter.
Filter?	<sp> (filter)<cr><lf>	Returns the reading filter.
FilterWin	nnn	Sets the filter window as a floating point value in pressure.
FilterWin?	<sp>+n.nnnnnE+nn<cr><lf>	Returns the filter window.
Gasdensity	Value in lb/cuft or "NITROGEN" or "DRY AIR"	Sets the height pressure correction gas density in lb/cuft.
Gasdensity?	<sp>+n.nnnnnE+nn<cr><lf>	Gets the height pressure correction gas density in lb/cuft.
Gastemp	Value in degrees F	Sets the height pressure correction gas temperature.
Gastemp?	<sp>+n.nnnnnE+nn<cr><lf>	Gets the height pressure correction gas temperature.
Gateway	nnn.nnn.nnn.nnn	Sets the Ethernet gateway address.
Gateway?	<sp>nnn.nnn.nnn.nnn<cr><lf>	Gets the Ethernet gateway address.
Gauge?	<sp>YES or NO<cr><lf>	Returns if the primary transducer is native gauge
HeadHeight	Value	Sets the height pressure correction height in active height pressure correction length units, which is either imperial (inches), or metric (cm).
HeadHeight?	<sp>+n.nnnnnE+nn<cr><lf>	Get the height pressure correction height in active height pressure correction length units, which is either imperial (inches), or metric (cm).
Height	Value in inches	Sets the height pressure correction height in inches.
Height?	<sp>+n.nnnnnE+nn<cr><lf>	Gets the height pressure correction height in inches.
Id?	<sp>MENSOR,CPC8000,ssssss,v.v.vv<cr><lf>	Ssssss is the serial number, v.v.vv is the CPC8000 software version.
IP	nnn.nnn.nnn.nnn	Sets the IP address of the instrument.
IP?	<sp>nnn.nnn.nnn.nnn<cr><lf>	Returns the IP address of the instrument.
Keylock	YES or NO	Locks or unlocks the entire touchscreen.
Keylock?	<sp>(YES or NO)<cr><lf>	Returns YES or NO .
Language	CCCCCC	Set the active display language. Accepts the following: ENGL, ENGL US, ENGL CA, ENGL GB, GERM DE, GERM SZ, DEUT DE, DEUT SZ, FREN, FREN CA, FREN SZ, FREN CH, FRAN , FRAN CA, FRAN SZ, FRAN CH, SPAN MX, SPAN SP, SPAN LAT, SPAN AL,ESPA, ESPA MX, ESPA SP, ESPA LAT, ESPA AL, PORT, PORT PT, PORT BZ, PORT BR, ITAL, POL, RUS, CHI, JAP, KOR. Each language may also be completely spelled out, i.e. ENGLISH instead of ENGL.
Language?	<sp>CCCCCC,(ABBREV)<cr><lf>	Returns the active display language, i.e. "ENGLISH (US)" or "DEUTSCH (DE)".
Lgravity	Value in active height pressure correction acceleration units	Sets the local gravity in either imperial (ft/s ²) or metric (m/s ²).
Lgravity?	<sp>+n.nnnnnE+nn<cr><lf>	Returns the local gravity in either imperial (ft/s ²) or metric (m/s ²).
LLimit	nnn	Alias for "Lowerlimit". → See ' Lowerlimit '
LLimit?	<sp>n.nnnnnE+nn<cr><lf>	Alias for "Lowerlimit"?. → See ' LowerLimit? '

8. Remote operation

Command	Data	Response/Function
List?	<sp>Pri,1,2;Sec,1,2;Bar,1<cr><lf>	Returns list of available transducers and turndowns. Turndowns are obsolete and therefore set to 1 for backward compatibility.
Listcal?	<sp>PRI,{sn},1,{mmddy};SEC,{sn},1,{mmddy},TER,{sn},1,{mmddy},BAR,{sn},{mmddy}<cr><lf>	Returns list of available transducers and turndowns' calibration dates.
Listrange?	<sp>PRI,1,min,max;SEC,1,min,max;TER,1,min,max;Bar,min,max<cr><lf>	Returns the ranges of the installed transducers.
Localgravity	Value in ft/s ²	Sets the local gravity in ft/s ² .
Localgravity?	<sp>+n.nnnnnE+nn<cr><lf>	Returns the local gravity in ft/s ² .
Loudness	nnn	Sets the speaker volume 0...100 %.
Loudness?	<sp>n.nnnnnE+nn<cr><lf>	Returns the speaker volume as 0 ... 100 %.
LowerLimit	nnn	Sets the lower control limit for the instrument.
LowerLimit?	<sp>+n.nnnnnE+nn<cr><lf>	Returns the lower control limit for the instrument in current units.
Lowovershoot		Does not apply to the CPC8000
Lowovershoot?	<sp>YES<cr><lf>	Returns YES .
Measure	None	Instrument placed in measure mode.
Measure?	<sp>(YES or NO)<cr><lf>	Returns YES if instrument is in measure mode. NO if otherwise.
MEDIADENSITY	"NITROGEN" or "DRYAIR"	Sets the media type to either the gas nitrogen or dry air.
MEDIADENSITY?	<sp>cccc<cr><lf>	Returns the media type.
MEDIATEMP	Value	Set the media temperature in active height pressure correction temperature units.
MEDIATEMP?	<sp>n.nnnnnE+nn<cr><lf>	Returns the media temperature in the active height pressure correction temperature units, as either imperial (°F) or metric (°C).
Mode	MEASURE, CONTROL, VENT	Sets the operation mode.
Mode?	<sp>XXXXXX<cr><lf>	Returns the operation mode.
Netmask	nnn.nnn.nnn.nnn	Sets the Ethernet network mask.
Netmask?	<sp>nnn.nnn.nnn.nnn<cr><lf>	Gets the Ethernet network mask.
NVR.ADAPTATION	<sp>(START,STOP,SLOW,FAST,CANCEL,0,1)<cr><lf>	Starts or stops controller adaption routine. Note: There is no difference between slow and fast. Both start the same controller adaptation process, and are only for backward compatibility.
NVR.ADAPTATION?	<sp>0 to -6<cr><lf>	Returns status of controller adaption routine where the response is: 0, OK -1, active -2, leakage or no pressure supply -3, pressure supply too high or wrong mode -4, default during controller adaption -5, calculation fault -6, abandoned process
NVR.ADAPTATION.CONFIG?	<n>	Returns index, name, and status at index n. Status can be " ERROR " (no file), " INVALID " (file exists but bad data), " VALID " (valid file), or " ACTIVE " (currently active configuration).

EN

8. Remote operation

EN

Command	Data	Response/Function
NVR.ADAPTATION.CONFIG.ACTIVE?		Returns index, name and status of the currently active regulator configuration (1 ... 8, or factory).
NVR.ADAPTATION.CONFIG.LOAD	<n>	Load regulator configuration from file <n> to regulator board and set as active.
NVR.ADAPTATION.CONFIG.NAME	<n>,<s>	Sets the name of the regulator configuration at index n (1 ... 8) to string s. s can contain alphanumeric characters or %-_ <sp>
NVR.ADAPTATION.CONFIG.NAME?	<n>	Returns name of regulator configuration at index n (1 ... 8).
NVR.ADAPTATION.CONFIG.SAVE	<n>	Save regulator board's current configuration to file at index <n> and set file <n> as active.
OSversion?		Returns the operating system version.
Outform	1 to 7	Sets the output format, see chapter 8.2 "Remote command set"
Outform?	<sp>X <lf>	Returns the output format.
Overrange		Sets the overrange percentage.
Overrange?	<sp>+n.nnnnnE+nn <lf>	Gets the overrange percentage.
Peakmax?	<sp>n.nnnnnE+nn <lf>	Returns the maximum pressure since peak reset was sent.
Peakmin?	<sp>n.nnnnnE+nn <lf>	Returns the minimum pressure since peak reset was sent.
Peakreset	None	Resets the peak values.
Port	nnnnnn	Sets the Ethernet port of the instrument.
Port?	<sp>nnnnn <lf>	Returns the Ethernet port of the instrument.
Ptype	Absolute or gauge	Sets the instrument pressure type. Emulation only works if the optional barometric transducer is installed.
Ptype?	<sp>CCCC <lf>	Returns "GAUGE", "GAUGE EMULATION", "ABSOLUTE", or "ABSOLUTE EMULATION". Returns the current pressure type and notes if it is an emulated pressure type.
Range?	<sp>+n.nnnnnE+nn <lf>	Alias for "RangeMax?". → See 'RangeMax?'
RangeMax?	<sp>n.nnnnnE+nn <lf>	Returns the maximum range of the active transducer in the current units.
RangeMin?	<sp>n.nnnnnE+nn <lf>	Returns the minimum range of the active transducer in the current units.
Rate?	<sp>n.nnnnnE+nn <lf>	Returns the rate reading of the instrument in current units / current time unit. → See 'Runits'
Rdecpt?	<sp>n <lf>	Returns the number of rate decimal points. → See 'Resolution'
Reference	{EXTVAC or ATM}	Not used, kept for backward compatibility.
Reference?	<sp>CCCC <lf>	Not used, kept for backward compatibility.
RELAYBD_VERSION?		Returns the relay board version
Release?	15 char string. EX: Release? Test_stand_1 Returns: <sp>(YES or NO), CCC...CCC <lf>	This command is used to release control of the instrument in a multiple computer environment. Yes if release is successful. No if instrument is being controlled with another computer. CCC... = name of controlling computer or AVAILABLE → See 'Acquire?' and 'Unlock'
Resolution	<n>	Sets the number of significant digits. ⇒ See 'Decpt'
Resolution?	<sp>n <lf>	Returns the number of significant digits. → See 'Decpt'

14739768.01 11/2024 en-co based on 018508001AT en-um 12/2022

8. Remote operation

EN

Command	Data	Response/Function
Rfilter	Value in %	Sets the % of the rate filter.
Rfilter?	<sp>n.nnnnnE+nn<cr><lf>	Returns the rate filter.
RFilterWin	nnn	Sets the rate filter window as a floating point value in pressure.
RFilterWin?	<sp>+n.nnnnnE+nn<cr><lf>	Returns the rate filter window
RStable?	YES or NO	Returns YES if the rate is stable, or NO if unstable.
RStableTime	0 to 65535	Sets the rate stable time to the number of seconds specified.
RStableTime?	<sp>XXXXXXXX<cr><lf>	Returns the rate stable time.
RStableWin	nnn	Alias for “ RStableWindow? ” → See RStableWindow
RStableWin?	<sp>+n.nnnnnE+nn<cr><lf>	Alias for “ RStableWindow? ”. → See RStableWindow?
RStableWindow	nnn	Sets the rate stable window as a % FS/s.
RStableWindow?	<sp>+n.nnnnnE+nn<cr><lf>	Returns the rate stable window.
Rsetpt	Value in current units	Sets the rate set point.
Rsetpt?	<sp>n.nnnnnE+nn<cr><lf>	Returns the rate set point.
Runits	Sec, min, hr	Sets the rate time unit.
Runits?	<sp>XXXX<cr><lf>	Returns the rate time unit.
RLLimit	nnn	Alias for “ RLowerLimit? ” → See RLowerLimit?
RLLimit?	<sp>n.nnnnnE+nn<cr><lf>	Alias for “ RLowerLimit? ”. → See RLowerLimit?
RLowerLimit	nnn	Set the rate lower control limit
RLowerLimit?	<sp>n.nnnnnE+nn<cr><lf>	Returns the rate lower control limit
RULimit	nnn	Alias for “ RUpperLimit? ”. → See RUpperLimit
RULimit?	<sp>n.nnnnnE+nn<cr><lf>	Alias for “ RUpperLimit? ”. → See RUpperLimit?
RUpperLimit	nnn	Sets the rate upper control limit
RUpperLimit?	<sp>n.nnnnnE+nn<cr><lf>	Returns the rate upper control limit
Rwindow	Value in current units	Sets rate exponential filter window
Rwindow?	<sp>n.nnnnnE+nn<cr><lf>	Returns rate exponential filter window
Save_cal		Save calibration values.
Save_linearity		Save linearity values.
Sbaud	9600, 19200, 38400, 57600, 115200	Sets the serial baud rate.
Sbaud?	<sp>XXXX<cr><lf>	Returns the serial baud data.
Sdata	7 or 8	Sets the serial data bits.
Sdata?	<sp>n<cr><lf>	Returns the serial data bits number.
Sensor	PRIMARY, SECONDARY, TERTIARY, QUATERNARY	Sets the active transducer.
Sensor?	<sp><s><td><cr><lf>	Returns active transducer in long string format.
Sensorid?	<sp><sensor#><sp>ID<sp>MENSOR,<sp><model>,<sp><SN>,<sp>V<version><cr><lf>	Returns the active transducer’s serial number and firmware version.
Setpoint	nnn.nnn	Sets the control set point for the instrument. Value must be inside upper and lower limits. Alias for “ Setpt ”
Setpoint?	<sp>nnn.nnnE+nn<cr><lf>	Returns the control set point in current units

8. Remote operation

EN

Command	Data	Response/Function
Setpoint%	nnn.nnn	Sets the control set point in %FS of primary transducer range
Setpoint%?	<sp>nnn.nnnnE+nn<cr><lf>	Returns the current set point in % of primary transducer range. Alias for “Setpt%?”
Setpt	nnn.nnn	Sets the control set point for the instrument. Value must be inside upper and lower limits.
Setpt?	<sp>+n.nnnnnE+nn<cr><lf>	Returns the control set point in current units.
Setpt%	nnn.nnn	Sets the control set point in % of current range.
Setptpct	nnn.nnn	Sets the control set point in % of current range.
Setptpct?	<sp>+n.nnnnnE+nn<cr><lf>	Returns the current set point in % of current range.
Span	nnn.nnn (desired pressure value)	Sets span on active transducer or for ?, clears previous value, must be > 50 % FS and has a 1 % limit. 'CALDISABLE' must be OFF/NO.
Span?	<sp>+n.nnnnnE+nn<cr><lf>	Returns span scale factor for active transducer.
Sparity	Even, ODD, NONE	Sets the serial parity.
Sparity?	<sp>CCCC<cr><lf>	Returns the serial parity.
Srqmask	Stable, error or both	Sets the CPC8000 to issue a service request (SRQ) over the IEEE when the pressure control is stable, or an error occurs. These are 80 hex and 40 hex respectively.
Srqmask?	<sp>{string}<cr><lf>	Returns “stable”, “error” or “error, stable” depending on the SRQ.
Sstop	1 or 2	Sets the serial stop bits.
Sstop?	<sp>X<cr><lf>	Returns the serial stop bits.
Stable?		Returns YES if instrument is stable or NO .
Stabledelay	0 to 65535	Sets the stable time to the number of seconds specified.
Stabledelay?	<sp>XXXXXX<cr><lf>	Returns the stable time.
Stabletime	0 to 65535	Sets the stable time to the number of seconds specified.
Stabletime?	<sp>+n.nnnnnE+nn<cr><lf>	Returns the stable time.
StableWin	nnn.nnn	Sets the stable window as a % FS.
StableWin?	<sp>n.nnnnnE+nn<cr><lf>	Returns the stable window.
Standby	None	Instrument placed in standby mode.
Standby?	<sp>(YES or NO)<cr><lf>	Returns YES if instrument is in standby, NO if otherwise.
Step	Value inside upper/lower limits and inside the range of the active transducer.	Sets the control step size for the instrument.
Step-		Jogs the set point down one step.
Step+		Jogs the set point up one step.
Step?	<sp>+n.nnnnnE+nn<cr><lf>	Returns the control step for the instrument.
Step%	Value in % of current range	Sets the control step in % of current range.
Steppct	Value in % of current range	Sets the control step in % of current range.
Steppct?	<sp>n.nnnnnE+nn<cr><lf>	Returns the current step in % of current range.
Subunits		Sets engineering units in secondary display. → See units text in chapter 14.4 “Conversion factors, millitorr”
Subunits?	<sp>CCCC<cr><lf>	Returns secondary display engineering units in a text string.
Subunits2		Sets engineering units in tertiary display. → See units text in chapter 14.4 “Conversion factors, millitorr”
Subunits2?	<sp>CCCC<cr><lf>	Returns tertiary display engineering units in a text string.

14739768.01 11/2024 en-co based on 018508001AT en-um 12/2022

8. Remote operation

EN

Command	Data	Response/Function
Tare	ON or OFF	Tares current reading to zero. The same tare value is applied to all measuring transducers.
Tare?	<sp>n.nnnnnE+nn<cr><lf>	Returns the tare value applied to all transducers in current units.
Termchar	CCCC	Sets the termination character for the active command set (for example the Mensor command set will be different from the SCPI command set). Accepts the following: CRLF, CR, LF, EOI, NONE, DEFAULT
Termchar?	<sp>CCCC<cr><lf>	Returns the termination character setting.
Timeouten	ON or OFF	Enables the Ethernet timeout.
Timeouten?	<sp>(YES or NO)<cr><lf>	Returns the Ethernet timeout state.
Timeoutsec	nnn	Sets the Ethernet timeout in seconds, to automatically close the socket if no activity has occurred. The default is 172800 seconds (2 days).
Timeoutsec?	<sp>nnnnnn<cr><lf>	Returns the Ethernet timeout in seconds.
Touchcal		Start the touchscreen calibration process.
Truepress	<n>,<f>	Used for a linearity calibration fix. Sets the internal transducer pressure for segment n. The value in segment n must be between the values of segments n-1 and n+1. End points must be within 1 % of the minimum and maximum of the range's span. → See ' Calculate_as_found_linearity '
Truepress?<sp><n>	<sp>+n.nnnnnE+nn<cr><lf>	Returns the reference pressure for the specified segment n.
Units	Units code or text in table below	Sets the instrument engineering units.
Units?	<sp>CCCC<cr><lf>	Returns the instrument units in a text string.
Unitbase1	→ See units code or text in chapter 14.4 "Conversion factors, millitorr"	Sets the user 1 custom units base to either psi, bar or pascals.
Unitbase1?	<sp>CCCC<cr><lf>	Returns the user 1 base units in a text string.
Unitbase2	→ See units code or text in chapter 14.4 "Conversion factors, millitorr"	Sets the user 2 custom units base to either psi, bar or pascals.
Unitbase2?	<sp>CCCC<cr><lf>	Returns the user 2 base units in a text string.
Unitfact1	Multiplier factor	Sets the custom unit 1's multiplier
Unitfact1?	<sp>n.nnnnnE+nn<cr><lf>	Returns the custom unit 1's multiplier.
Unitfact2	Multiplier factor	Sets the custom unit 2's multiplier.
Unitfact2?	<sp>n.nnnnnE+nn<cr><lf>	Returns the custom unit 2's multiplier.
ULimit	nnn	Alias for ' UpperLimit '. ⇒ See ' UpperLimit '
ULimit?	<sp>xxxxxx<cr><lf>	Alias for ' UpperLimit? '. → See ' UpperLimit? '
Unlock	None	Releases Acquire locks → See ' Acquire? ' and ' Release? '
UpperLimit	nnn	Sets the upper control limit for the active transducer.
UpperLimit?	<sp>+n.nnnnnE+nn<cr><lf>	Returns the upper control limit for the active transducer.
Vent	None	Instrument placed in vent mode.
Vent?	<sp>(YES or NO)<cr><lf>	Returns YES if instrument is in vent, NO if otherwise.
Vent_Limit	nnn	Set the pressure where the vent valve will open completely during a controlled vent

8. Remote operation

Command	Data	Response/Function
Vent_Limit?	<sp>n.nnnnnE+nn<cr><lf>	Returns the vent limit in current units.
Vent_Rate	nnn	Set the controlled vent rate
Vent_Rate?	<sp>n.nnnnnE+nn<cr><lf>	Returns the vent rate in current units.
WID?	<sp>MENSOR,WIKASN,X.XX.XX<cr><lf>	Returns manufacturer, instrument's WIKA serial number, instrument software version number
Window	Value in current units	Sets the exponential filter window for the active transducer.
Window?	<sp>n.nnnnnE+nn<cr><lf>	Returns the exponential filter window for the active transducer.
Zero	Desired pressure or ?	Sets zero to set pressure or for ?, clears previous value. 'CALDISABLE' must be OFF/NO . → See chapter 7.5.2.5.5 "Remote zero calibration".
Zero?	<sp>n.nnnnnE+nn<cr><lf>	Returns zero point offset for active transducer.

EN

8. Remote operation

8.4 SCPI WIKA command set

Command	Response/Function
MEASure	
[:PRESsure][R]?	Returns the pressure from range R.
:TEMPerature[R]?	Returns the temperature from range R.
:RATE[R]?	Returns the rate/sec from range R.
:BAROmetric?	Returns the barometric pressure.
CALibration	
[:PRESsure][R]	
:MODE?	Returns 1 = calibrated or 0 = not calibrated.
:DATE?	Returns date of cal "MM/DD/YYYY".
:DATE<i,i,i>	Sets date of cal "YYYY/MM/DD".
:ZERO?	Returns zero point offset.
:ZERO<n>	Sets the zero point offset. → See chapter 7.5.2.5.5 "Remote zero calibration".
:ZERO:RUN	Start autozero sequence. → See chapter 7.5.2.5.5 "Remote zero calibration".
:ZERO:STOP	Stop autozero sequence.
:ZERO:INITiate?	Returns zero point status.
:ZERO:INITiate	Ignored
SENSe	
[:PRESsure][R]	
:NAME?	Returns transducer name string.
:MODE?	Returns "ABSOLUTE" or "GAUGE".
:MODE ABS GAUGE	Sets pressure type.
:ABS?	Returns native transducer type 0 = GAUGE 1 = ABSOLUTE
:RESolution?	Returns resolution (float).
:RANGe	
[:UPPer]?	Returns maximum range.
:LOWer?	Returns minimum range.
:UNIT	
[:NAME]?	Returns ASCII units (mixed case).
:VALue?	Returns the units conversion factor.
:REFerence	
[:HEIGHt]<n>	Sets the height pressure correction height.
:HEIGHt?	Returns the height pressure correction height.
:MODE?	Returns "OFF", "GAS", or "LIQUID".
:MODE OFF GAS LIQUID	Sets the height pressure correction mode.
:MEDium<n>	Sets the medium density.
:MEDium?	Returns medium.
:ACTive<n>	Sets the active sensor.
ACTive?	Returns the active transducer.

EN

8. Remote operation

EN

Command	Response/Function																																												
SYSTem																																													
:DATE<i,i,i>	Not used, kept for backward compatibility.																																												
:DATE?	Not used, does not cause an error, does not return a response.																																												
:TIME <i,i,i>	Not used, kept for backward compatibility.																																												
:TIME?	Not used, does not cause an error, does not return a response.																																												
:ERRor[:NEXT]?	Returns error code, description.																																												
:KLOCK ON OFF 1 0	Sets the keylock state.																																												
:PRESet	Loads known state values.																																												
:SAVe	No function (not needed).																																												
:VERSion?	Returns SCPI version 1994.0.																																												
TEST																																													
:ELECTronic?	Returns "OK"																																												
:RELay<n>?	Returns status of digital output <n>.																																												
:RELay<n> ON OFF	Turns the digital output on or off <n>.																																												
UNIT																																													
:NAME<n>?	Returns the units string for units code <n>.																																												
:FACTor<n>?	Returns the units conversion for units code <n>.																																												
:[PRESSure] bar mbar Pa psi	Sets the pressure units.																																												
:[PRESSure]?	Returns the pressure units.																																												
:USER																																													
:FACTOR <n>, <f>	Sets the multiplier to <f> for user unit <n>																																												
:FACTOR ? <n>	Returns the multiplier <f> for user unit <n>																																												
:BASE <n>, <s>	Sets the base engineering units for user unit <n>, options are psi, bar, pascal.																																												
:BASE? <n>	Returns the base engineering units for user unit <n> as a text string																																												
:INDEX<n>	Sets the index number.																																												
:INDEX?	Returns the index number. <table border="1" data-bbox="690 1245 1289 1581"> <thead> <tr> <th>Index</th> <th>Unit</th> <th>Index</th> <th>Unit</th> </tr> </thead> <tbody> <tr> <td>0</td> <td>bar</td> <td>10</td> <td>inH₂O (20 °F)</td> </tr> <tr> <td>1</td> <td>mbar</td> <td>11</td> <td>inH₂O (60 °F)</td> </tr> <tr> <td>2</td> <td>Pa</td> <td>12</td> <td>ftH₂O (4 °C)</td> </tr> <tr> <td>3</td> <td>psi</td> <td>13</td> <td>mmHg (0 °C)</td> </tr> <tr> <td>4</td> <td>atm</td> <td>14</td> <td>cmHg (4 °C)</td> </tr> <tr> <td>5</td> <td>kp/cm²</td> <td>15</td> <td>inHg (0 °C)</td> </tr> <tr> <td>6</td> <td>lbf/ft²</td> <td>16</td> <td>inHg (60 °F)</td> </tr> <tr> <td>7</td> <td>kPa</td> <td>17</td> <td>% of range</td> </tr> <tr> <td>8</td> <td>cmH₂O (4 °C)</td> <td>18</td> <td>User unit 1</td> </tr> <tr> <td>9</td> <td>inH₂O (4 °C)</td> <td>19</td> <td>User unit 2</td> </tr> </tbody> </table>	Index	Unit	Index	Unit	0	bar	10	inH ₂ O (20 °F)	1	mbar	11	inH ₂ O (60 °F)	2	Pa	12	ftH ₂ O (4 °C)	3	psi	13	mmHg (0 °C)	4	atm	14	cmHg (4 °C)	5	kp/cm ²	15	inHg (0 °C)	6	lbf/ft ²	16	inHg (60 °F)	7	kPa	17	% of range	8	cmH ₂ O (4 °C)	18	User unit 1	9	inH ₂ O (4 °C)	19	User unit 2
Index	Unit	Index	Unit																																										
0	bar	10	inH ₂ O (20 °F)																																										
1	mbar	11	inH ₂ O (60 °F)																																										
2	Pa	12	ftH ₂ O (4 °C)																																										
3	psi	13	mmHg (0 °C)																																										
4	atm	14	cmHg (4 °C)																																										
5	kp/cm ²	15	inHg (0 °C)																																										
6	lbf/ft ²	16	inHg (60 °F)																																										
7	kPa	17	% of range																																										
8	cmH ₂ O (4 °C)	18	User unit 1																																										
9	inH ₂ O (4 °C)	19	User unit 2																																										
OUTPut																																													
:STATe ON OFF 1 0	ON or 1 = control OFF or 0 = measure																																												
:STATe?	Returns 0 for measure 1 for control.																																												
:MODE MEASure CONTrol VENT	Sets the mode indicated.																																												
:MODE?	Returns the operating mode string.																																												
:STABLE?	Returns 1 if stable 0 if not.																																												

8. Remote operation

EN

Command	Response/Function
:AUTOvent ON OFF 1 0	Autovent causes the controller to vent when a setpt of 0 is sent while in gauge or gauge emulation.
:AUTOvent?	Returns the state of the vent mode.
:AUTORange ON OFF 1 0	Turns autorange on or off.
:AUTORange?	Returns "ON" or "OFF".
[SOURce]	
:PRESsure	
[:LEVel]	
[:IMMediate]	
[:AMPLitude]<n>	Sets the set point.
[:AMPLitude]?	Returns the set point.
:SLEW<n>	Sets the rate set point in % FS/sec.
:SLEW?	Returns the rate set point.
:TOLerance<n>	Sets the stable window in % FS/s.
:TOLerance?	Returns the stable window in % FS/sec.
CALCulate	
:LIMit	
:LOWer<n>	Set the minimum control limit.
:LOWer?	Set the minimum control limit.
:UPPer<n>	Set the maximum control limit.
:UPPer?	Set the maximum control limit.
:VENT <n>	Pressure at which the vent solenoid opens for an uncontrolled vent.
:VENT?	Returns the pressure at which the vent solenoid opens.
:VRATE	Sets the rate at which the controlled vent goes to atmosphere.
:VRATE?	Returns the rate at which the controlled vent goes to atmosphere.
:SYSTem	
:DETECT SLOW FAST CANCEL	Starts or stops controller adaption routine. Note: There is no difference between slow and fast. Both start the same controller adaptation process, and are only for backward compatibility.
:DETECT?	Returns status of controller adaption routine where the response is: 0, OK -1, active -2, leakage or no pressure supply -3, pressure supply too high or wrong mode -4, default during controller adaption -5, calculation fault -6, abandoned process
:TARE	
:STATe ON/OFF/1/0	Tare the current reading. The same tare value is applied to all measuring transducers.
:STATe?	Returns the tare value.

14739768.01 11/2024 en-co based on 018508001AT en-um 12/2022

8. Remote operation

8.5 SCPI error messages and error codes

When an error occurs, the error symbol in the lower right hand corner of the main screen turns yellow and becomes a button.

- ▶ When pressed, the error log is shown and all errors are cleared.
 - ⇒ Note, going to the error log will put the instrument in measure mode for safety reasons.
- Error -500 is a pneumatics error. This message will be different depending on the pneumatic error.
- Error 999 is a general purpose error which couldn't be categorised in the pre-defined errors.

Code	Error string returned
0	No error
-101	Undefined character
-102	Syntax error
-103	Undefined separator
-104	Parameter data type error
-109	Parameter missing
-110	Undefined header
-113	Undefined command
-114	Parameter out of range
-313	Calibration data not found
-315	Configuration data not found
-350	Error queue overflow
-410	Query interrupted
-500	Regulator error message
600	Default configuration not found
601	Calibration mode active! Deactivate before setting C0..C3
602	Sensor not available
701	DCS instance not available
702	Create DCS instance failed
703	DCS still active
704	Command currently not allowed
999	General purpose error message

8.6 Error emulation – PCS 400 emulated commands

Command	Data	Response/Function
_pcs4 autorange <value>	0 or 1	1 turns autorange on, 0 = off
_pcs4 autorange?		Returns 1 if in autorange, 0 if in Range Hold
_pcs4 cal a/d		Not used, kept for backward compatibility.
_pcs4 cal atm		Performs pcs400 1 pt cal
_pcs4 cal span <value>		Sets the span of the active transducer to <value>
_pcs4 cal zero <value>		Sets the zero of the active transducer to <value>
_pcs4 cal_disable_off		Enables zero or span calibrations if previously disabled.
_pcs4 cal_disable_on		Prevents zero or span calibrations
_pcs4 ctrl <value><sp><unitno>		Sets control value – will take effect immediately if instrument is in control mode.
_pcs4 ctrl?		Returns the current control point in current engineering units.
_pcs4 ctrlmax<value>		Sets maximum control value.

8. Remote operation

EN

Command	Data	Response/Function
_pcs4 ctrlmax?		Returns current maximum control pressure.
_pcs4 ctrlmin<value>		Sets minimum control value.
_pcs4 ctrlmin?		Returns current minimum control pressure.
_pcs4 emul?		Returns ptype emulation mode
_pcs4 default		Sets default values into instrument.
_pcs4 err?		Returns the error number and description.
_pcs4 exhaustp?		Returns exhaust pressure
_psc4 filtersetting		Sets the filter %
_pcs4 filtersetting?		Returns the filter %
_pcs4 filterwindow		Sets the filter window
_pcs4 filterwindow?		Returns the filter window
_pcs4 func ctrl <value><unitno>		Instrument placed in control mode at <value> pressure in <unitno> units.
_pcs4 func emul		Toggles ptype emulation mode
_pcs4 func F1		Toggles ptype emulation mode
_pcs4 func meas		Instrument placed in measure mode.
_pcs4 func stby <unitno>		Instrument placed in standby mode in <unitno> units
_pcs4 func vent <unitno>		Instrument placed in vent mode in <unitno> units
_pcs4 id?		Returns instrument ID
_pcs4 lang PCS2		Sets command set to PCS 200
_pcs4 list?		Returns range list
_pcs4 opt?		Returns option list (old pcs400 format)
_pcs4 option?		Returns option list.
_pcs4 outform<digit>		Sets output format.
_pcs4 outform?		Returns the current output format.
_pcs4 peakreset		Resets peak readings
_pcs4 peakunit		Selects Peak+ or Peak-
_pcs4 peakunit?		Returns Peak+ or Peak-
_pcs4 rangemax?		Returns the max. pressure of the active transducer.
_pcs4 rangemin?		Returns the min. pressure of the active transducer.
_pcs4 rate		Sets the control rate
_pcs4 rate?		Returns the pressure rate
_pcs4 rateunit		Selects the rate units (SEC or MIN)
_pcs4 rateunit?		Returns the rate units
_pcs4 reading?		Returns the current pressure
_pcs4 sourcep?		Returns the supply pressure
_pcs4 span?		Returns the stored multiplication factor from the active transducer & turndown.
_pcs4 stabledelay<value>	1 to 255	Sets the number of consecutive readings that the pressure must remain within the stable window for a pressure stable indication.
_pcs4 stabledelay?		Returns the number of readings that must be within the stable window before a stable pressure is indicated.
_pcs4 stablewindow<value>		Sets the pressure window that is used to indicate pressure is stable.
_pcs4 stablewindow?		Returns the pressure tolerance allowed for a stable pressure indication as a % of span of the active transducer.

8. Remote operation

Command	Data	Response/Function
_pcs4 stat?		Returns Mode and stable flag status "mode, stable CR LF"
_pcs4 unit <unitno>		Sets the instrument to specified engineering units
_pcs4 unit?		Returns the current engineering units and the type of transducer (A, G, D)
_pcs4 xducer?		Returns the number of the currently active transducer.
_pcs4 xducerid?		Returns the internal transducer number, serial number, minimum and maximum transducer range.
_pcs4 zero?		Returns the stored zero offset of the active transducer and turndown in the current pressure units.

EN

9. Faults

9. Faults

Personnel: skilled personnel



If faults cannot be eliminated by means of the listed measures, the instrument must be taken out of operation immediately.

Contact the manufacturer.

If a return is needed, please follow the instructions given in chapter 11.2 "Return".



For contact details, see chapter 1 "General information" or the back page of the operating instructions.

Type of fault	Problem	Measures
No measurement(s) are displayed on the screen. The entire area of the screen is dark.	The instrument has not initialised after switching on.	Switch off the instrument and switch on again after approx. 5 seconds.
	After switching on again, the screen still remains dark	Check that the power cord is connected properly. Have authorised technical staff check that the auxiliary power is correct.
		Check both fuses for continuity. If necessary, replace fuses, see chapter 10.1.1 "Changing the fuses".
Display does not respond to touch	Malfunction during operation	Switch off the instrument and switch on again after approx. 5 seconds.
	Electrostatic discharges on the screen However, the instrument continues to operate properly. Data will still be transmitted	Switch off the instrument and switch on again after approx. 5 seconds.
Values are not maintained	Unstable control	Contact the manufacturer.
The set point value is not reached	Incorrect supply pressure	Check whether the value of the supply pressure is the value required.
	Leaking lines	Leak test the plumbing. Replace them if necessary

10. Maintenance, cleaning and calibration

10. Maintenance, cleaning and calibration

Personnel: skilled personnel

Tools: screwdriver

EN



For contact details, see chapter 1 “General information” or the back page of the operating instructions.

10.1 Maintenance

This instrument is maintenance-free.

Repairs must only be carried out by the manufacturer.

This does not apply to the fuse replacement.

Only use original parts, see chapter 13 “Accessories and spare parts”.

10.1.1 Changing the fuses



CAUTION!

Material damage due to incorrect fuse

Inserting the wrong fuses can damage the instrument.

- ▶ Only use fuses with 2.5 A 250 V SLO-BLO 5x20.
- ▶ Check both fuses for continuity.

The power cord connection socket includes two internal fuses, see Fig “10.1.2-B Changing the fuses”.

1. Switch off the power to the instrument (mains socket).
2. Disconnect the mains cable from the instrument.
3. Use a screwdriver to lever the fuse holder out of the holder, see Fig “10.1.2-A Position of the fuses”.
4. Check both fuses.
5. Exchange defective fuses, see Fig “10.1.2-B Changing the fuses”.
6. Refit the fuse holder into the plug.
⇒ Ensure that it is fully inserted.
7. Reconnect the instrument and switch it on.

10.1.2 Position of the fuses



Fig. 10.1.2-A Position of the fuses



Fig. 10.1.2-B Changing the fuses

10. Maintenance, cleaning and calibration

10.2 Cleaning



CAUTION!

Physical injuries and damage to property and the environment

Residual media can result in a risk to persons, the environment and equipment.

- ▶ Wear the requisite protective equipment.
- ▶ Carry out the cleaning process in accordance with the manufacturer's instructions.



CAUTION!

Damage to property due to improper cleaning

Improper cleaning may lead to damage to the instrument.

- ▶ Do not use any aggressive cleaning agents.
- ▶ Do not use any hard or pointed objects for cleaning.
- ▶ Do not use any abrasive cloths or sponges.

1. Before cleaning, correctly disconnect the instrument from the pressure supply, switch it off and disconnect it from the mains.
2. Clean the instrument with a moist cloth.
⇒ Electrical connections must not come into contact with moisture.
3. Wash or clean the dismantled instrument, in order to protect persons and the environment from exposure to residual media.

10.3 Calibration

DAkKS calibration certificate or official certificates:

It is recommended having the instrument regularly calibrated by the manufacturer, with time intervals of approx. 12 months. The default settings will be corrected if necessary.

10.3.1 Calibration services

In addition to servicing our own products, Mensor can perform a complete pressure calibration service, up to 2,050 bar [30,000 psi], for all of your pressure instruments. This service includes an attestation of conformity and a calibration certificate as well as a record of traceability to the pressure standards of the United States National Institute of Standards and Technology (NIST).

10.3.2 Certifications and accreditations

Mensor is registered to ISO 9001:2008. The calibration program at Mensor is accredited by A2LA, as complying with both the ISO/IEC 17025:2005 and the ANSI/NCSL Z540-1-1994 standards.

11. Dismounting, return and disposal

11. Dismounting, return and disposal

Personnel: skilled personnel

EN

11.1 Dismounting



DANGER!

Danger to life due to electrical voltages

Upon contact with live parts, there is a direct danger to life.

- ▶ The dismounting of the instrument may only be carried out by skilled personnel.
- ▶ Remove the instrument once the system has been isolated from power sources.



WARNING!

Physical injury

During dismounting there is a risk of high pressures.

- ▶ Wear the requisite protective equipment.
- ▶ Disconnect test and calibration installations once the system has been depressurised.

11.2 Return

Strictly observe the following when shipping the instrument:

- All instruments delivered to WIKA must be free from any kind of hazardous substances (acids, bases, solutions, etc.) and must therefore be cleaned before being returned, see chapter 10.2 “Cleaning”.
- When returning the instrument, use the original packaging or a suitable transport packaging.



With hazardous substances, include the material safety data sheet for the corresponding medium.

To avoid damage:

1. Wrap the instrument in an anti-static plastic film.
2. Place the instrument in a container, surrounded on all sides with at least 4 inches of shock attenuation material such as Styrofoam peanuts.
3. If possible, place a bag, containing a desiccant, inside the packaging.
4. Label the shipment as carriage of a highly sensitive measuring instrument.



Information on returns can be found under the heading “Service” on our local website (return application).



If the instrument will be subjected to frequent transport then the optional transport case shown in chapter 4.9.1 “Transport case” might be an economical solution. This wheeled case is very rugged and provides complete and long-term protection against rough handling.

11. Dismounting, return and disposal

11.3 Disposal

Incorrect disposal can put the environment at risk.

Dispose of instrument components and packaging materials in an environmentally compatible way and in accordance with the country-specific waste disposal regulations.

Disposal of electrical appliances



This instrument is labelled in accordance with the EU Waste Electrical and Electronic Equipment (WEEE) directive. This instrument must not be disposed of with household waste.

- ▶ Hand in old instruments for environmentally friendly disposal at a designated collection point for the disposal of electrical and electronic devices.
- ▶ Ensure a proper disposal in accordance with national regulations and observe the currently applicable regulations.

12. Specifications

12. Specifications

Accuracy specifications presented herein are obtained by comparison with primary standards traceable to the National Institute of Standards and Technology (NIST). A calibration data report has been provided with your new CPC8000 instrument, traceable to NIST. The calibration program at Mensor is accredited to both ISO/IEC 17025:2005 and Z540-1-1994 by A2LA. Mensor, LP is registered to ISO 9001:2008.

12.1 Reference pressure transducer

Reference pressure transducer model CPR8000

Reference pressure transducer model CPR8000			
Pressure range			
Accuracy ¹⁾	0.008 % FS ²⁾	0.008 % IS-50 ³⁾	0.008 % IS-33 ⁴⁾
Gauge pressure ⁵⁾	0 ... 0.35 up to 0 ... 400 bar [0 ... 5 up to 0 ... 6,000 psi]	0 ... 1 up to 0 ... 400 bar [0 ... 15 up to 0 ... 6,000 psi]	0 ... 1 up to 0 ... 100 bar [0 ... 15 up to 0 ... 1,500 psi]
Bidirectional	-1 ... +1 up to -1 ... 400 bar [-15 ... +15 up to -15 ... 6,000 psi]	-1 ... 10 up to -1 ... 400 bar [-15 ... 145 up to -15 ... 6,000 psi]	-1 ... 10 up to -1 ... 100 bar [-15 ... 145 up to -15 ... 1,500 psi]
Absolute pressure ⁶⁾	0 ... 0.5 up to 0 ... 401 bar abs. [0 ... 7.5 up to 0 ... 6,015 psi abs.]	0 ... 1 up to 0 ... 401 bar abs. [0 ... 15 up to 0 ... 6,015 psi abs.]	0 ... 1 up to 0 ... 101 bar abs. [0 ... 15 up to 0 ... 1,515 psi abs.]
Precision ⁷⁾	0.004 % FS		
Calibration interval	365 days ⁸⁾	365 days	365 days

- 1) It is defined by the total measurement uncertainty, which is expressed with the coverage factor ($k = 2$) and includes the following factors: the intrinsic performance of the instrument, the measurement uncertainty of the reference instrument, long-term stability, influence of ambient conditions, drift and temperature effects over the compensated range during a periodic zero point correction every 30 days.
- 2) FS = Full span = end of measuring range – start of measuring range
- 3) 0.008 % IS-50 accuracy: Between 0 ... 50 % of the full scale, the accuracy is 0.008 % of the half full scale and between 50 ... 100 % of the full scale, the accuracy is 0.008 % of reading.
- 4) 0.008 % IS-33 accuracy: Between 0 ... 33 % of the full scale, the accuracy is 0.008 % of the lower third of the full scale and between 33 ... 100 % of the full scale, the accuracy is 0.008 % of reading.
- 5) For pressure ranges from $\geq 100 \dots \leq 138$ barg [$\geq 1,500 \dots \leq 2,000$ psig] will be sealed gauge transducers.
- 6) The minimum calibrated range of absolute transducer(s) is 600 mTorr.
- 7) It is defined as the combined effects of linearity, repeatability and hysteresis throughout the stated compensated temperature range.
- 8) 180 days for pressure ranges below 1 bar [15 psi] gauge or absolute and -1 ... +1 bar [-15 ... +14.5 psi] bidirectional. 365 days for the remainder of specified ranges.

12.2 Barometric reference

Barometric reference	
Measuring range	<ul style="list-style-type: none"> ■ 552 ... 1,172 mbar abs. ■ 8 ... 17 psi abs. ■ 552 ... 1,172 hPa abs.
Accuracy ¹⁾	0.01 % of reading
Function	The barometric reference can be used to switch pressure types ²⁾ , absolute \Leftrightarrow gauge. With gauge transducers, the measuring range of the transducers must begin with -1 bar [-15 psi] in order to carry out a complete absolute pressure emulation.

- 1) It is defined by the total measurement uncertainty, with the coverage factor ($k = 2$) and includes the intrinsic performance of the instrument, the measurement uncertainty of the reference instrument, long-term stability, influence of ambient conditions, drift and temperature effects over the compensated range with recommended zero point adjustment every 30 days.
- 2) For a pressure type emulation, we recommend a native absolute transducer, since the zero point drift can be eliminated through a zero point adjustment.

12. Specifications

12.3 Base instrument

Base instrument	
Instrument	
Instrument version	<ul style="list-style-type: none"> ■ Desktop case ■ 19" rack-mounting kit with side panels incl. rack-mounting kit
Dimensions	→ See technical drawings
Weight	Approx. 22.2 kg [49 lb], with all internal options selected
Warm-up time	Approx. 30 minutes
Digital display	
Type of display	10.1" colour TFT with capacitive touchscreen
Display resolution	4 ... 7 digits depending on range and units
Measuring range	<ul style="list-style-type: none"> ■ 0 ... 0.35 bar to 0 ... 400 bar [0 ... 5 psi to 0... 6,000 psi] ■ -1 ... -1 bar to -1 ... 400 bar [-15 ... +15 psi to -15 ... 6,000 abs.] ■ 0 ... 0.5 bar abs. to 0 ... 401 bar abs. [0 ... 7.5 psi abs. to 0... 6,015 psi abs.] Depending on the reference pressure transducer and accuracy of model CPR8000
Pressure type	<ul style="list-style-type: none"> ■ Gauge ■ Bidirectional ■ Absolute pressure
Unit	38 and two freely programmable pressure units

EN

12.4 Control parameter

Control parameter	
Control stability	0.002 % FS
Control speed	< 60 s ¹⁾
Control range	0.05 ... 100 % FS
Rate control	0.1 ... 10 % FS/s
Minimum control pressure	0.0017 bar [0.025 psi] over exhaust pressure or 0.05 % FS → Whichever is greater
Test volume	<ul style="list-style-type: none"> ■ 50 ... 300 ccm ■ Test volume greater than 300 ccm available on request

1) Regarding a 10 % FS pressure increase in a 150 ml test volume

12.5 Pressure connection

Pressure connection				
Connections	<ul style="list-style-type: none"> ■ 5 ports with 7/16"-20 SAE female ■ 1 port with 10-32 UNF female thread 			
Filter elements	All pressure ports have a 40-micron filters			
Pressure port adapters	<ul style="list-style-type: none"> ■ 6 mm Swagelok® tube fitting ■ Others on request 			
Barometer port adapters	<ul style="list-style-type: none"> ■ Barb fitting ■ 6 mm tube fitting ■ ¼" tube fitting 			
Wetted parts	<table style="width: 100%; border: none;"> <tr> <td style="vertical-align: top;"> <ul style="list-style-type: none"> ■ KEL-F ■ PTFE ■ FKM/FPM ■ Buna N </td> <td style="vertical-align: top;"> <ul style="list-style-type: none"> ■ Ceramic ■ Tungsten carbide ■ Silicon ■ Nickel-plated SS </td> <td style="vertical-align: top;"> <ul style="list-style-type: none"> ■ Aluminium (7000 series) ■ Brass (300 series) ■ Stainless steel (300 series) </td> </tr> </table>	<ul style="list-style-type: none"> ■ KEL-F ■ PTFE ■ FKM/FPM ■ Buna N 	<ul style="list-style-type: none"> ■ Ceramic ■ Tungsten carbide ■ Silicon ■ Nickel-plated SS 	<ul style="list-style-type: none"> ■ Aluminium (7000 series) ■ Brass (300 series) ■ Stainless steel (300 series)
<ul style="list-style-type: none"> ■ KEL-F ■ PTFE ■ FKM/FPM ■ Buna N 	<ul style="list-style-type: none"> ■ Ceramic ■ Tungsten carbide ■ Silicon ■ Nickel-plated SS 	<ul style="list-style-type: none"> ■ Aluminium (7000 series) ■ Brass (300 series) ■ Stainless steel (300 series) 		

12. Specifications

EN

Pressure connection

Permissible pressure media	<ul style="list-style-type: none"> ■ Dry, clean air ■ Nitrogen (ISO 8573-1:2010 class 5.5.4 or better)
Overpressure protection	Safety relief valve fixed to reference pressure transducer and adjusted to specific customised measuring range
Permissible pressure	
Supply port	Max. 110 % FS
Measure/Control port	Max. 105 % FS

12.6 Communication

Communication

Interface	<ul style="list-style-type: none"> ■ Ethernet ■ IEEE-488 ■ USB ■ RS-232
Baud rate	<ul style="list-style-type: none"> ■ 9600 ■ 19200 ■ 38400 ■ 57600 ■ 115200
Command sets	<ul style="list-style-type: none"> ■ Mensor ■ WIKA SCPI ■ Others on request
Response time	< 100 ms
Digital I/O	
Digital input	DC 3.3 V or DC 5 V; current limited by 330 Ω resistor
Digital output	0.5 A at AC 125 V 1 A at DC 24 V

12.7 Voltage supply

Voltage supply

Operating voltage	<ul style="list-style-type: none"> ■ AC 100 ... 120 V, 50/60 Hz ■ AC 220 ... 240 V, 50/60 Hz
Power consumption	Max. 130 VA
Supply voltage fluctuation	±10 %
Fuse	1.6 A, 250 V; SLO-BLO 5 x 20 mm

12.8 Operating conditions

Operating conditions

Place of use	Indoor Not for wet locations
Altitude	Up to 3,048 m [10,000 ft] above sea level
Operating temperature	15 ... 40 °C [59 ... 104 °F]
Compensated temperature range	15 ... 45 °C [59 ... 113 °F]

12. Specifications

Operating conditions	
Storage temperature range	0 ... 70 °C [32 ... 158 °F]
Relative humidity, condensation	0 ... 95 % r. h. (non-condensing)
Transducers' mounting position	Horizontal or slightly tilted
Permissible pollution degree	Degree 2
EMC (HF field)	EN 61326-1 emission (group 1, class A) and immunity (industrial application)

EN

12.9 Approvals

Logo	Description	Region
CE	EU declaration of conformity	European Union
	EMC directive ¹⁾ EN 61326 emission (group 1, class A) and immunity (industrial application)	
	Low Voltage Directive	
	RoHS directive	
UK CA	UKCA	United Kingdom
	Electromagnetic compatibility regulations	
	Electrical equipment designed for use within certain voltage limits in support of the electrical equipment (safety) regulations	
	Restriction of hazardous substances (RoHS) regulations	

- 1) Warning!
This is class A equipment for emitted interference and is intended for use in industrial environments. In other environments, e.g. residential or commercial installations, it can interfere with other equipment under certain conditions. In such circumstances the operator is expected to take the appropriate measures.

12.10 Certificates

Certificates	
Calibration ¹⁾	
Reference pressure transducer	<ul style="list-style-type: none"> ■ A2LA calibration certificate (traceable and accredited in accordance with ISO/IEC 17025) ■ DAkkS calibration certificate – gauge pressure (traceable and accredited in accordance with ISO/IEC 17025) ■ DAkkS calibration certificate – absolute pressure (traceable and accredited in accordance with ISO/IEC 17025)
Barometric reference	<ul style="list-style-type: none"> ■ Without ■ A2LA calibration certificate (traceable and accredited in accordance with ISO/IEC 17025) ■ DAkkS calibration certificate for barometric reference (traceable and accredited in accordance with ISO/IEC 17025)
Recommended calibration interval	1 year (dependent on conditions of use)

- 1) Calibration in a horizontal position / operating position.

For approvals and certificates, see website

13. Accessories and spare parts





13. Accessories and spare parts

Description ¹⁾		Order code
		CPX-A-C8
-	Desktop case	-D-
-	19" built-in case With side pieces, EU	-R-
-	With side pieces, NAM	-U-
	Barometric reference Measuring range: 8 ... 17 psi abs. Accuracy down to 0.01 % of reading	-3-
	Measuring range: 552 ... 1,172 mbar abs. Accuracy down to 0.01 % of reading	-K-
	Measuring range: 552 ... 1,172 hPa abs. Accuracy down to 0.01 % of reading	-L-
	Calibration adapter For reference pressure transducers, voltage supply and software	-4-
	Calibration adapter For barometric reference, voltage supply and software	-5-
	Transport case	-6-
	Silencer	-7-
	RS-232 interface cable	-9-
-	Vacuum pump	-2-
	Adapter set 6 mm Swagelok® male thread (4 adapters) Max. 137 bar [2,000 psi] Material: brass	-M-
	Adapter set 6 mm Swagelok® male thread (4 adapters) Max. 400 bar [6,000 psi] Material: stainless steel	-C-
	Adapter set ¼" tube fitting (4 adapters) Max. 137 bar [2,000 psi] Material: brass	-I-

EN

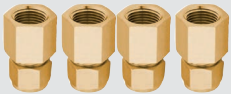
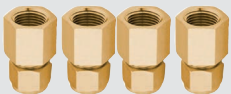
13. Accessories and spare parts

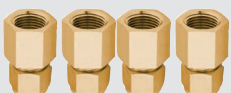
EN

Description ¹⁾		Order code
		CPX-A-C8
	Adapter set 1/4" tube fitting (4 adapters) Max. 400 bar [6,000 psi] Material: stainless steel	-E-
	Adapter set 1/8 BSPG female thread (4 adapters) Max. 137 bar [2,000 psi] Material: brass	-B-
	Adapter set 1/4 NPT female thread (4 adapters) Max. 137 bar [2,000 psi] Material: brass	-N-
	Adapter set 1/4 NPT female thread (4 adapters) Max. 400 bar [6,000 psi] Material: stainless steel	-A-
	Adapter set 1/8 NPT female thread (4 adapters) Max. 137 bar [2,000 psi] Material: brass	-S-
	Adapter set 1/8 NPT female thread (4 adapters) Max. 400 bar [6,000 psi] Material: stainless steel	-F-
Ordering information for your enquiry:		
		↓ []
		1. Order code: CPX-A-C8 2. Option:

1) The figures are an example and may change depending on the state of the art in design, material composition and representation.

WIKA accessories can be found online at www.wika.com.

14. Annex

14. Annex

14.1 Measuring units (unit no.)

The units command selects the measuring units to be output on the bus and the display.

Code	Description	Output format
1	Pounds per square inch	psi
2	Bar	bar
3	Millibar	mbar
4	Pascal	Pa
5	Kilopascal	kPa
6	Hectopascal	hPa
7	Megapascal	MPa
8	Grams per square centimetre	g/cm ²
9	Kilograms per square centimetre	kg/cm ²
10	Inch of mercury column at 0 °C	inHg 0 °C
11	Inch of mercury column at 60 °F	inHg 60 °F
12	Inch of water column at 4 °C	inH ₂ O 4 °C
13	Inch of water column at 20 °C	inH ₂ O 20 °C
14	Inch of water column at 60 °F	inH ₂ O 60 °F
15	Feet of water column at 4 °C	ftH ₂ O 4 °C
16	Feet of water column at 20 °C	ftH ₂ O 20 °C
17	Feet of water column at 60 °F	ftH ₂ O 60 °F
18	Millimetres of water column at 4 °C	mmH ₂ O 4 °C
19	Millimetres of water column at 20 °C	mmH ₂ O 20 °C
20	Centimetres of water column at 4 °C	cmH ₂ O 4 °C
21	Centimetres of water column at 20 °C	cmH ₂ O 20 °C
22	Metres of water column at 4 °C	mH ₂ O 4 °C
23	Metres of water column at 20 °C	mH ₂ O 20 °C
24	Microns of mercury at 0 °C	μHG 0 °C
25	Millimetres of mercury at 0 °C	mmHg 0 °C
26	Centimetres of mercury column at 0 °C	cmHg 0 °C
27	Metres of mercury column at 0 °C	mHg 0 °C
28	Ounces per square inch	osi
29	Pounds per square foot	pfs
30	Tons per square inch	tsi
31	Tons per square foot	tsf
32	Inch of seawater at 0 °C 3.5 % salinity	inSW
33	Feet of seawater at 0 °C 3.5 % salinity	ftSW
34	Metres of seawater at 0 °C 3.5 % salinity	mSW
35	Torr	Torr
36	Millitorr	mTorr
37	Dyne per square centimetre	dyn/cm ²
38	Percent of full scale	% FS
n/a	User units 1	User-defined
n/a	User units 2	User-defined

EN

14. Annex

14.2 Conversion factors, bar

The following table lists factors which should be used as multipliers when converting other pressure units to or from bar.

Code	Description	Unit	p [bar] / p [Unit]	p [Unit] / p [bar]
0	Bar	bar	1.000000E+00	1.000000E+00
1	Millibar	mbar	1.000000E-03	1.000000E+03
2	Pascal	Pa	1.000000E-05	1.000000E+05
3	Pound-force / inch ²	psi	6.894757E-02	1.450377E+01
4	Standard atmosphere (760 Torr)	atm	1.013250E+00	9.869233E-01
5	Technical atmosphere	kp/cm ²	9.806650E-01	1.019716E+00
6	Pound-force / foot ²	lbf/ft ²	4.788026E-04	2.088543E+03
7	Kilopascal	kPa	1.000000E-02	1.000000E+02
8	Centimetres of water column at 4 °C	cmH ₂ O 4 °C	9.806380E-04	1.019744E+03
9	Inch of water column at 4 °C	inH ₂ O 4 °C	2.490820E-03	4.014742E+02
10	Inch of water column at 20 °C	inH ₂ O 20 °C	2.486400E-03	4.021879E+02
11	Inch of water column at 60 °F	inH ₂ O 60 °F	2.488400E-03	4.018647E+02
12	Feet of water column at 4 °C	ftH ₂ O 4 °C	2.988980E-02	3.345623E+01
13	Millimetre of mercury column at 0 °C (Torr)	mmHg 0 °C	1.333224E-03	7.500615E+02
14	Centimetres of mercury column at 4 °C	cmHg 4 °C	1.333224E-02	7.500615E+01
15	Inch of mercury column at 0 °C	inHg 0 °C	3.386380E-02	2.953006E+01
16	Inch of mercury column at 60 °F	inHg 60 °F	3.376850E-02	2.961340E+01
17	--			
18	User unit 1	User-defined		
19	User unit 2	User-defined		
20	User unit 2	User-defined		

EN

14. Annex

14.3 Conversion factors, PSI

The values listed in the column "To convert from PSI" are the values imbedded in the instrument program. The values listed under "To convert to PSI" are internally calculated approximations based on the imbedded values.

Code	Pressure unit	To convert from PSI	To convert to PSI
1	psi	1	1
2	bar	0.06894757	14.50377
3	mbar	68.94757	0.01450377
4	Pa	6894.757	0.0001450377
5	hPa	68.94757	0.01450377
6	kPa	6.894757	0.1450377
7	MPa	0.006894757	145.0377
8	g/cm ²	70.30697	0.01422334
9	kg/cm ²	0.07030697	14.22334
10	inHg 0 °C	2.036020	0.4911544
11	inHg 60 °F	2.041772	0.4897707
12	inH ₂ O 4 °C	27.68067	0.03612629
13	inH ₂ O 20 °C	27.72977	0.03606233
14	inH ₂ O 60 °F	27.70759	0.03609119
15	ftH ₂ O 4 °C	2.306726	0.4335149
16	ftH ₂ O 20 °C	2.310814	0.4327480
17	ftH ₂ O 60 °F	2.308966	0.4330943
18	mmH ₂ O 4 °C	703.0890	0.001422295
19	mmH ₂ O 20 °C	704.336	0.001419777
20	cmH ₂ O 4 °C	70.30890	0.01422295
21	cmH ₂ O 20 °C	70.4336	0.01419777
22	mH ₂ O 4 °C	0.7030890	1.422295
23	mH ₂ O 20 °C	0.704336	1.419777
24	μHg 0 °C	51715.08	0.00001933672
25	mmHg 0 °C	51.71508	0.01933672
26	cmHg 0 °C	5.171508	0.1933672
27	mHg 0 °C	0.05171508	19.33672
28	osi	16	0.0625
29	psf	144	0.006944444
30	tsi	0.0005	2000
31	tsf	0.072	13.88889
32	inSW 0 °C 3.5 % salinity	26.92334	0.03714250
33	ftSW 0 °C 3.5 % salinity	2.243611	0.445710
34	mSW 0 °C 3.5 % salinity	0.6838528	1.462303
35	Torr	51.71508	0.01933672
36	mTorr	51715.08	0.00001933672
37	dyn/cm ²	68947.57	0.00001450377
38	% FS	(psi/range) x 100	(% FS x range) x 100
n/a	User unit 1	User-defined	User-defined
n/a	User unit 2	User-defined	User-defined

EN

14. Annex

14.4 Conversion factors, millitorr

The following table lists factors which should be used as multipliers when converting other pressure units to or from millitorr.

Code	Pressure unit	To convert from millitorr	To convert to millitorr
1	psi	0.0001933672	51715.08
2	inHg 0 °C	0.00003936995	25400.08909
3	inHg 60 °F	0.00003948117	25328.53093
4	inH ₂ O 4 °C	0.0005352534	1868.273977
5	inH ₂ O 20 °C	0.0005362028	1864.966281
6	inH ₂ O 60 °F	0.0005357739	1866.458778
7	ftH ₂ O 4 °C	0.00004460451	22419.25773
8	ftH ₂ O 20 °C	0.00004468356	22379.59744
9	ftH ₂ O 60 °F	0.00004464783	22397.50637
10	mTorr	1.0	1.00000000
11	inSW 0 °C 3.5 % salinity	0.0005206091	1920.827359
12	ftSW 0 °C 3.5 % salinity	0.00004338408	23049.92831
13	atm	0.00001315786	760002.2299
14	bar	0.00001333220	750063.6259
15	mbar	0.001333220	750.0636259
16	mmH ₂ O 4 °C	0.0135954	73.5540997
17	cmH ₂ O 4 °C	0.001359544	735.5409971
18	mH ₂ O 4 °C	0.00001359544	73554.09971
19	mmHg 0 °C	0.001	1000.000000
20	cmHg 0 °C	0.0001	10000.00000
21	Torr	0.001	1000.000000
22	kPa	0.0001333220	7500.636259
23	Pa	0.1333220	7.500636259
24	dyn/cm ²	1.333220	0.750063626
25	g/cm ²	0.001359506	735.561166
26	kg/cm ²	0.000001359506	735561.166
27	mSW 0 °C 3.5 % salinity	0.00001322347	75623.11663
28	osi	0.0003093875	3232.1992
29	psf	0.002784488	359.132477
30	tsf	0.000001392244	718265.0575
32	μHg 0 °C	1.0	1.00000000
33	tsi	0.00000000966836	103430160.00
34	mHg 0 °C	0.000001	1000000.00
35	hPa	0.001333220	750.0636259
36	MPa	0.0000001333220	7500636.259
37	mmH ₂ O 20 °C	0.01361955	73.42388114
38	cmH ₂ O 20 °C	0.001361955	734.2388114
39	mH ₂ O 20 °C	0.00001361955	73423.88114

EN

WIKA subsidiaries worldwide can be found online at www.wika.com.



Mensor Corporation
201 Barnes Drive
San Marcos, TX 78666 • USA
Tel. (+1) 512 3964200-15
E-mail sales@mensor.com
www.mensor.com



Importer for UK
WIKAL Instruments Ltd
Unit 6 and 7 Goya Business park
The Moor Road
Sevenoaks
Kent
TN14 5GY



WIKAL Alexander Wiegand SE & Co. KG
Alexander-Wiegand-Straße 30
63911 Klingenberg • Germany
Tel. +49 9372 132-0
info@wika.de
www.wika.de